

SMD Power Inductor CD104B



Under Development



Description

- Ferrite core construction.
- Magnetically unshielded.
- L × W × H: 10.3 × 9.3 × 4.3 mm Max.
- Product weight: 1.2 g(Ref.)
- Moisture Sensitivity Level: 1
- RoHS compliance.
- Qualified to AEC-Q200.

Environmental Data

- Operating temperature range: -40°C ~ +125°C (including coil's self temperature rise)
- Storage temperature range: -40°C ~ +125°C
- Solder reflow temperature: 260 °C peak.

Packaging

- Carrier tape and reel packaging.

Applications

- Automotive and other high temperature, high reliability application.

Dimension - [mm]

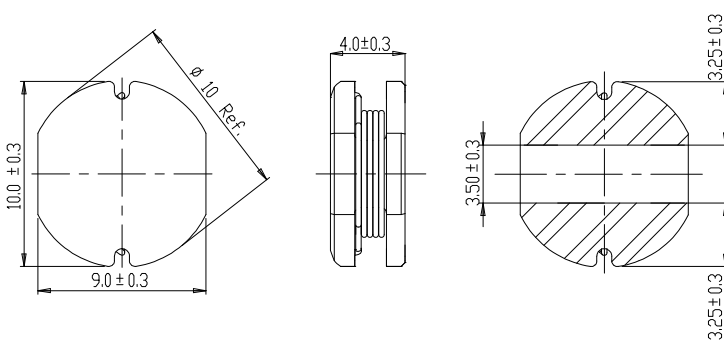

Land pattern and Schematics - [mm]

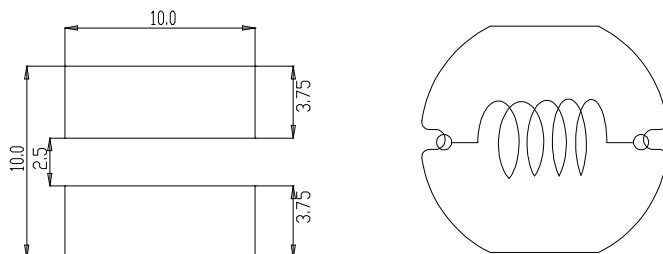

SMD Power Inductor CD104B

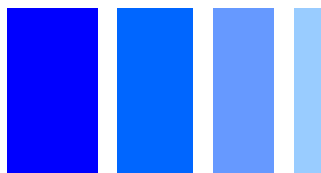

 **sumida**

Under Development

Electrical Characteristics

Part name.	Stamp	Inductance [Within] ※1	D.C.R. (Ω) [Max.] (Typ.) (at 25°C)	Saturation current (A) ※2		Temperature rise current (A) ※3
				(at 25°C)	(at 125°C)	
CD104BNP-100MC	100M	10 μH ±20%	51.6m(41.2m)	3.12	2.05	3.30
CD104BNP-120MC	120M	12 μH ±20%	56.3m(45.0m)	2.88	1.92	3.20
CD104BNP-150MC	150M	15 μH ±20%	67.0m(53.6m)	2.56	1.72	2.90
CD104BNP-180MC	180M	18 μH ±20%	77.8m(62.2m)	2.32	1.52	2.76
CD104BNP-220MC	220M	22 μH ±20%	83.9m(67.1m)	2.24	1.44	2.50
CD104BNP-270MC	270M	27 μH ±20%	96.1m(76.8m)	2.01	1.24	2.48
CD104BNP-330MC	330M	33 μH ±20%	114.3m(91.4m)	1.80	1.18	2.30
CD104BNP-390MC	390M	39 μH ±20%	139.5m(111.6m)	1.64	1.07	2.10
CD104BNP-470MC	470M	47 μH ±20%	175.8m(140.6m)	1.52	1.00	1.80
CD104BNP-560MC	560M	56 μH ±20%	199.3m(159.4m)	1.36	0.91	1.70
CD104BNP-680MC	680M	68 μH ±20%	235.3m(188.2m)	1.25	0.84	1.55
CD104BNP-820MC	820M	82 μH ±20%	274.8m(219.8m)	1.16	0.74	1.45
CD104BNP-101MC	101M	100 μH ±20%	340.8m(272.6m)	1.05	0.68	1.30
CD104BNP-121MC	121M	120 μH ±20%	415.8m(332.6m)	0.91	0.59	0.98
CD104BNP-151MC	151M	150 μH ±20%	520.8m(416.6m)	0.80	0.52	0.88
CD104BNP-181MC	181M	180 μH ±20%	644.5m(515.6m)	0.74	0.49	0.78
CD104BNP-221MC	221M	220 μH ±20%	747.0m(597.6m)	0.65	0.44	0.75
CD104BNP-271MC	271M	270 μH ±20%	984.3m(787.4m)	0.58	0.40	0.69
CD104BNP-331MC	331M	330 μH ±20%	1.14(908.8m)	0.56	0.37	0.64
CD104BNP-391MC	391M	390 μH ±20%	1.27(1.06)	0.51	0.34	0.60
CD104BNP-471MC	471M	470 μH ±20%	1.61(1.34)	0.46	0.30	0.55
CD104BNP-561MC	561M	560 μH ±20%	1.91(1.59)	0.41	0.27	0.49
CD104BNP-681MC	681M	680 μH ±20%	2.20(1.83)	0.40	0.26	0.46
CD104BNP-821MC	821M	820 μH ±20%	2.49(2.07)	0.38	0.24	0.43
CD104BNP-102MC	102M	1.0mH ±20%	3.08(2.57)	0.34	0.22	0.39

※1. Inductance measuring condition: at 100kHz.

※2. Saturation current: The value of D.C. current when the inductance decreases to 70% of it's nominal value.

※3. Heating current: The value of D.C. current when the temperature rise is $\Delta t=40^{\circ}\text{C}$ ($T_a=20^{\circ}\text{C}$).

SMD Power Inductor CD104B

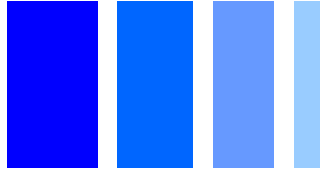

Under Development

Saturation Current & Temperature Rise Graph

— L (25°C) — L (125°C) — ΔT

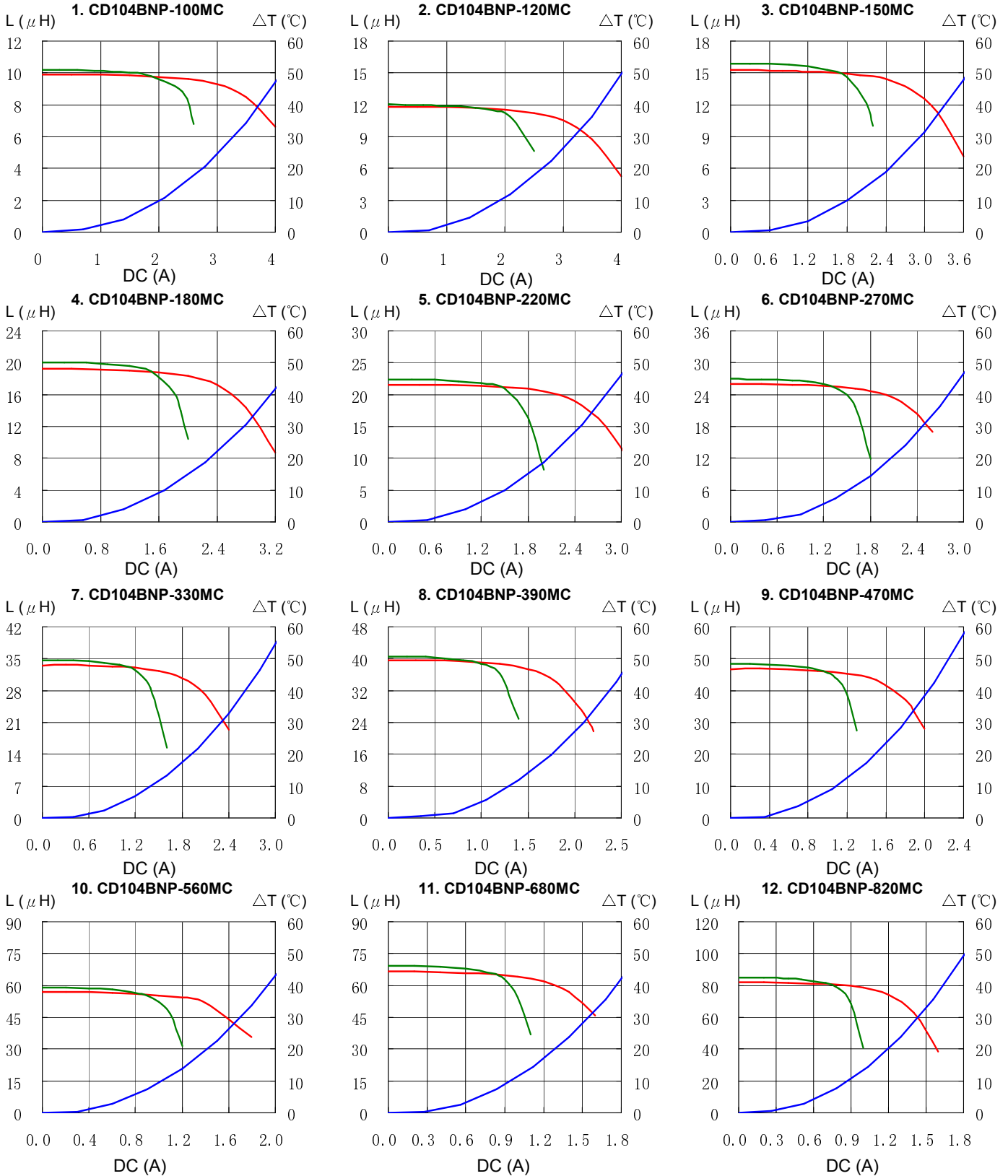

SMD Power Inductor CD104B

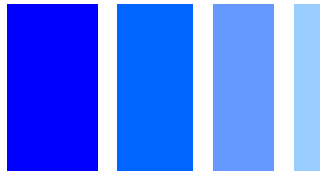

Under Development

Saturation Current & Temperature Rise Graph

— L (25°C) — L (125°C) — ΔT

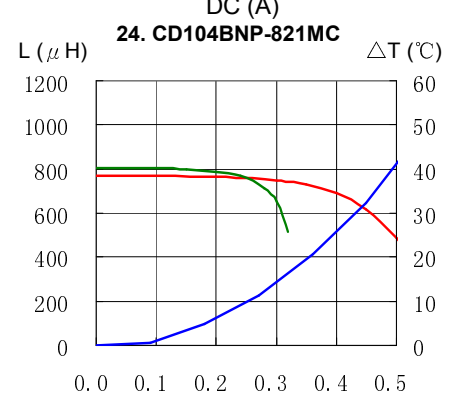
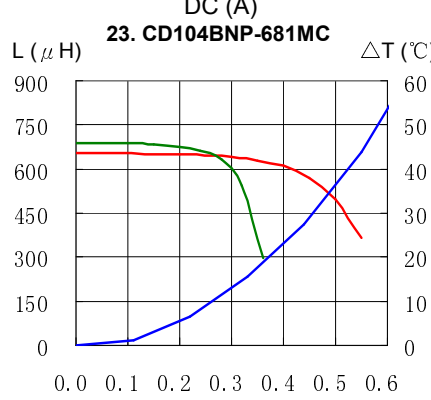
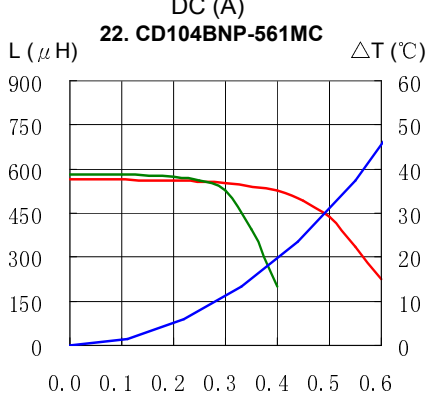
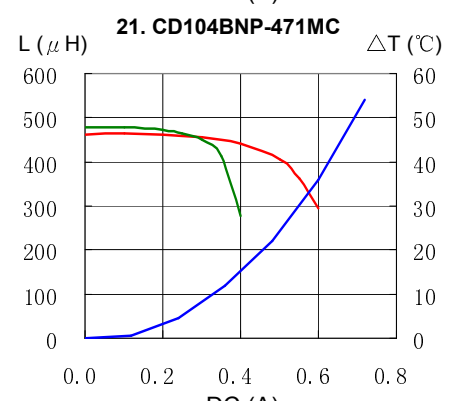
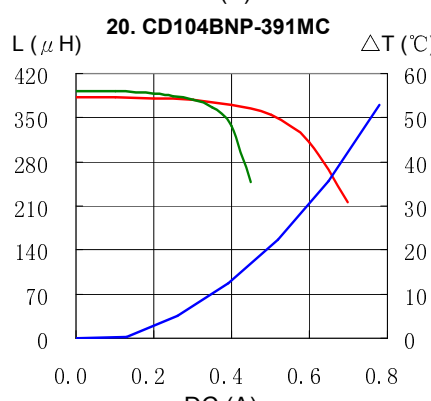
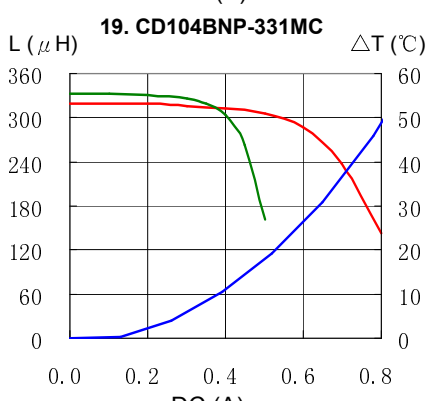
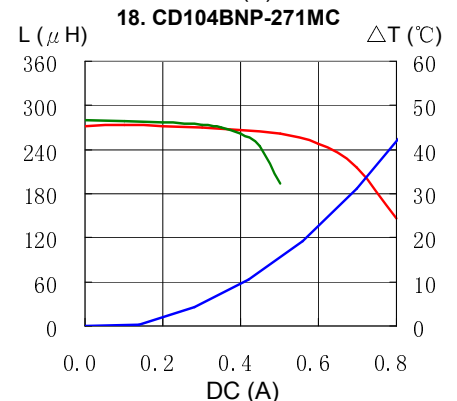
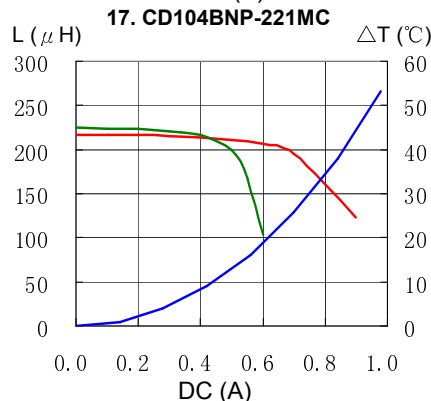
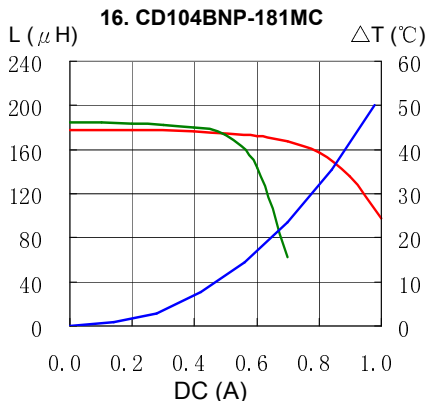
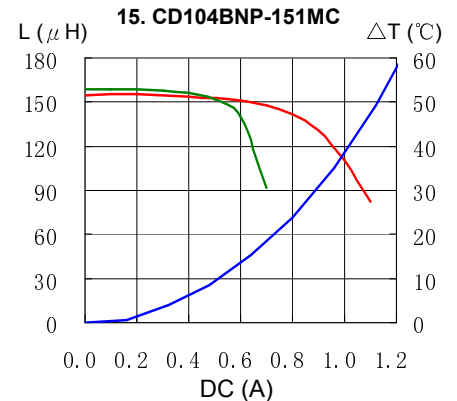
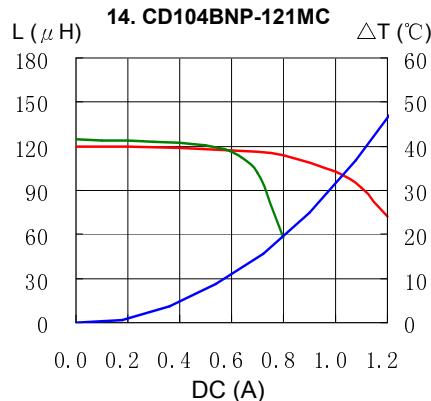
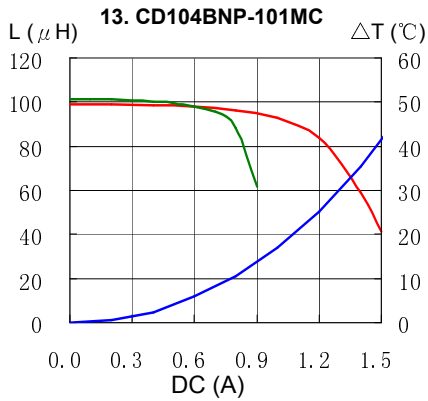

SMD Power Inductor CD104B

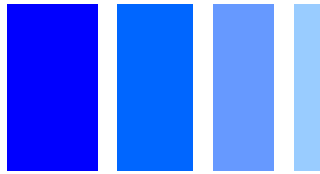

sumida

Under Development

Saturation Current & Temperature Rise Graph

— L (25°C) — L (125°C) — ΔT

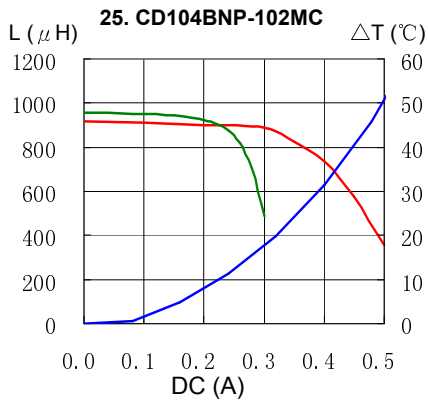

Solder Reflow Condition

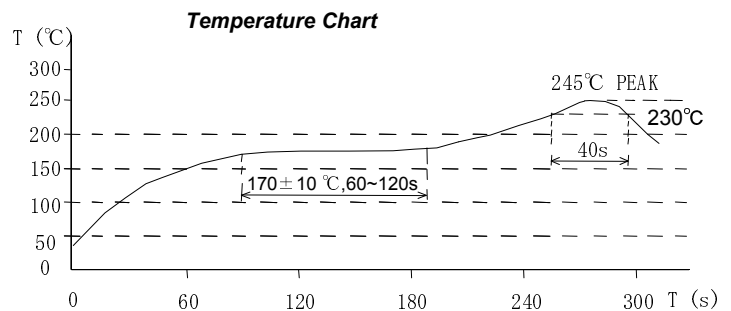
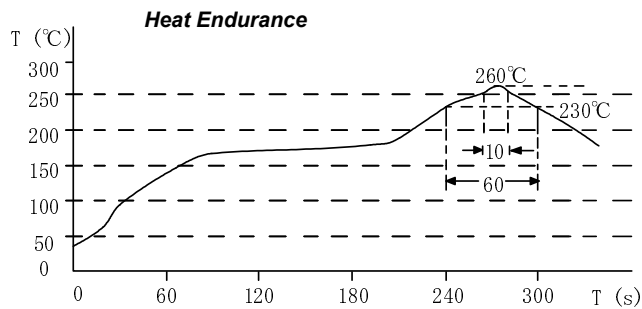

Please refer to the sales offices on our website - <http://www.sumida.com>

Hong Kong
Tel.+852-2880-6688
FAX.+852-2565-9600
sales@hk.sumida.com

Tokyo
Tel.+81-3-5202-7112
FAX.+81-3-5202-7105
sales@jp.sumida.com

Chicago
Tel.+1-847-545-6700
FAX. +1-847-545-6720
sales@us.sumida.com

Shanghai
Tel.+86-021-5836-3299
FAX.+86-021-5836-3266
shanghai.sales@cn.sumida.com

Seoul
Tel.+82-2-6237-0777
FAX.+82-2-6237-0778
sales@kr.sumida.com

Oberzell
Tel.+49-8591-937-0
FAX. +49-8591-937-103
contact@sumida-eu.com

Shenzhen
Tel.+86-755-8291-0228
FAX.+86-755-8291-0338
shenzhen.sales@cn.sumida.com

Singapore
Tel.+65-6296-3388
FAX.+65-6296-3390
sales@sg.sumida.com

Neumarkt
Tel.+49-9181-4509-110
FAX. +49-9181-4509-310
infocomp@eu.sumida.com

Taipei
Tel.+886-2-8751-2737
FAX.+886-2-8751-2738
sales@tw.sumida.com

San Jose
Tel.+1-408-321-9660
FAX.+1-408-321-9308
sales@us.sumida.com