

P-channel Enhancement-mode Power MOSFET

Low gate-charge

Simple drive requirement

Fast switching

 **Pb-free; RoHS compliant.**

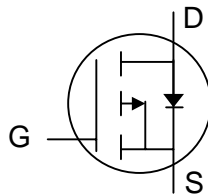

BV_{DSS} -20V

$R_{DS(ON)}$ 65m Ω

I_D -4.2A

DESCRIPTION

The SSM2305GN is in a SOT-23-3 package, which is widely used for lower power commercial and industrial surface mount applications. This device is suitable for low-voltage applications such as DC/DC converters and general switching applications.

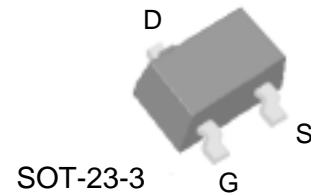

ABSOLUTE MAXIMUM RATINGS

Symbol	Parameter	Rating	Units
V_{DS}	Drain-Source Voltage	-20	V
V_{GS}	Gate-Source Voltage	± 12	V
$I_D @ T_A=25^\circ\text{C}$	Continuous Drain Current ³	-4.2	A
$I_D @ T_A=70^\circ\text{C}$	Continuous Drain Current ³	-3.4	A
I_{DM}	Pulsed Drain Current ^{1,2}	-10	A
$P_D @ T_A=25^\circ\text{C}$	Total Power Dissipation	1.38	W
	Linear Derating Factor	0.01	W/ $^\circ\text{C}$
T_{STG}	Storage Temperature Range	-55 to 150	$^\circ\text{C}$
T_J	Operating Junction Temperature Range	-55 to 150	$^\circ\text{C}$

THERMAL DATA

Symbol	Parameter	Value	Unit
$R_{\theta JA}$	Maximum Thermal Resistance, Junction-ambient ³	90	$^\circ\text{C}/\text{W}$

ELECTRICAL CHARACTERISTICS (at T_j = 25°C, unless otherwise specified)

Symbol	Parameter	Test Conditions	Min.	Typ.	Max.	Units
BV _{DSS}	Drain-Source Breakdown Voltage	V _{GS} =0V, I _D =-250uA	-20	-	-	V
ΔBV _{DSS} /ΔT _j	Breakdown Voltage Temperature Coefficient	Reference to 25°C, I _D =-1mA	-	-0.1	-	V/°C
R _{DS(ON)}	Static Drain-Source On-Resistance	V _{GS} =-10V, I _D =-4.5A	-	-	53	mΩ
		V _{GS} =-4.5V, I _D =-4.2A	-	-	65	mΩ
		V _{GS} =-2.5V, I _D =-2.0A	-	-	100	mΩ
		V _{GS} =-1.8V, I _D =-1.0A	-	-	250	mΩ
V _{GS(th)}	Gate Threshold Voltage	V _{DS} =V _{GS} , I _D =-250uA	-0.5	-	-	V
g _{fs}	Forward Transconductance	V _{DS} =-5V, I _D =-2.8A	-	9	-	S
I _{DSS}	Drain-Source Leakage Current (T _j =25°C)	V _{DS} =-20V, V _{GS} =0V	-	-	-1	uA
	Drain-Source Leakage Current (T _j =55°C)	V _{DS} =-16V, V _{GS} =0V	-	-	-10	uA
I _{GSS}	Gate-Source Leakage	V _{GS} = ± 12V	-	-	±100	nA
Q _g	Total Gate Charge ²	I _D =-4.2A	-	10.6	-	nC
Q _{gs}	Gate-Source Charge	V _{DS} =-16V	-	2.32	-	nC
Q _{gd}	Gate-Drain ("Miller") Charge	V _{GS} =-4.5V	-	3.68	-	nC
t _{d(on)}	Turn-on Delay Time ²	V _{DS} =-15V	-	5.9	-	ns
t _r	Rise Time	I _D =-4.2A	-	3.6	-	ns
t _{d(off)}	Turn-off Delay Time	R _G =6Ω, V _{GS} =-10V	-	32.4	-	ns
t _f	Fall Time	R _D =3.6Ω	-	2.6	-	ns
C _{iss}	Input Capacitance	V _{GS} =0V	-	740	-	pF
C _{oss}	Output Capacitance	V _{DS} =-15V	-	167	-	pF
C _{rss}	Reverse Transfer Capacitance	f=1.0MHz	-	126	-	pF

Source-Drain Diode

Symbol	Parameter	Test Conditions	Min.	Typ.	Max.	Units
V _{SD}	Forward On Voltage ²	I _S =-1.2A, V _{GS} =0V	-	-	-1.2	V
t _{rr}	Reverse Recovery Time	I _S =-4.2A, V _{GS} =0V,	-	27.7	-	ns
Q _{rr}	Reverse Recovery Charge	dI/dt=100A/μs	-	22	-	nC

Notes:

1. Pulse width limited by maximum junction temperature.
2. Pulse width ≤300us, duty cycle ≤2%.
3. Surface-mounted on 1 in² copper pad on FR4 board; 270°C/W when mounted on minimum copper pad.

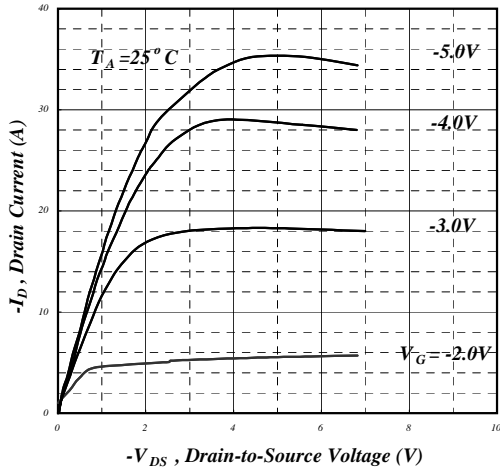

Fig 1. Typical Output Characteristics

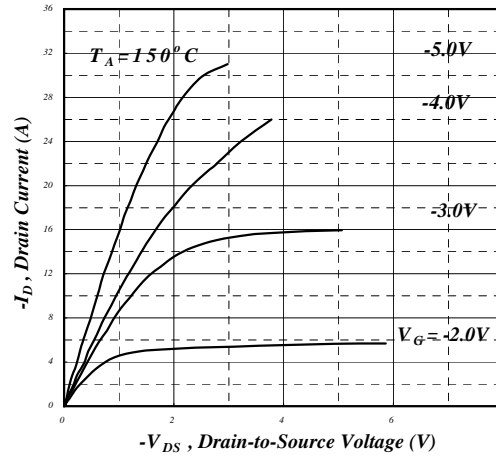

Fig 2. Typical Output Characteristics

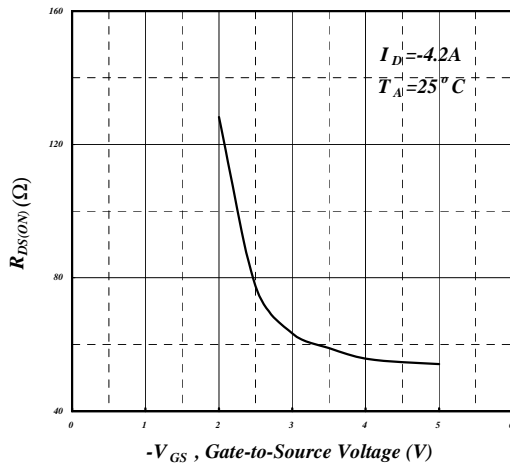

Fig 3. On-Resistance vs. Gate Voltage

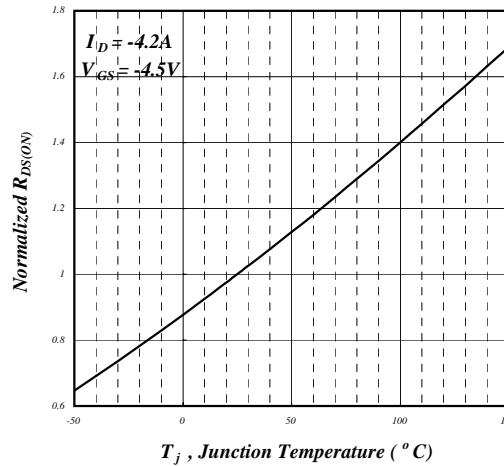

Fig 4. Normalized On-Resistance vs. Junction Temperature

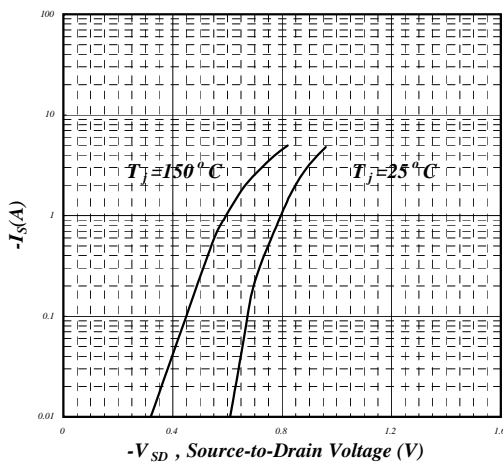

Fig 5. Forward Characteristic of Reverse Diode

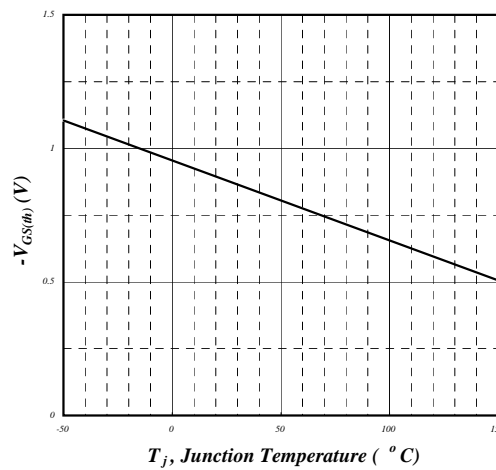

Fig 6. Gate Threshold Voltage vs. Junction Temperature

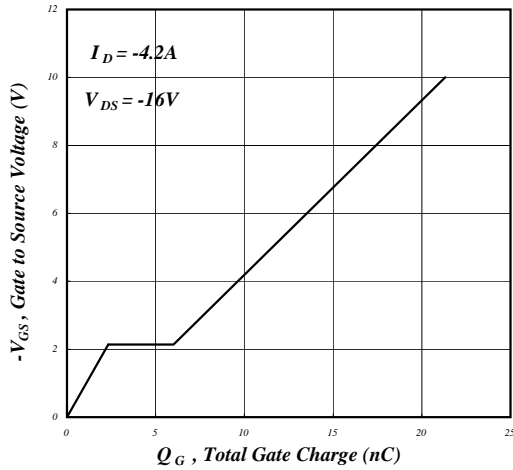

Fig 7. Gate Charge Characteristics

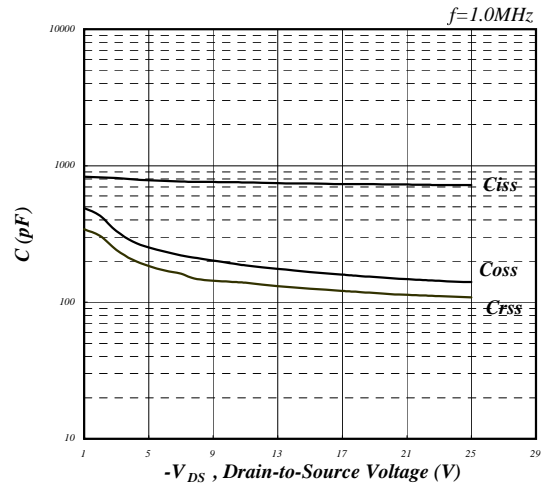

Fig 8. Typical Capacitance Characteristics

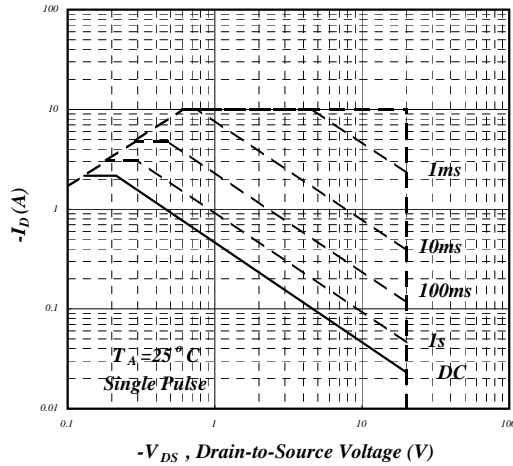

Fig 9. Maximum Safe Operating Area

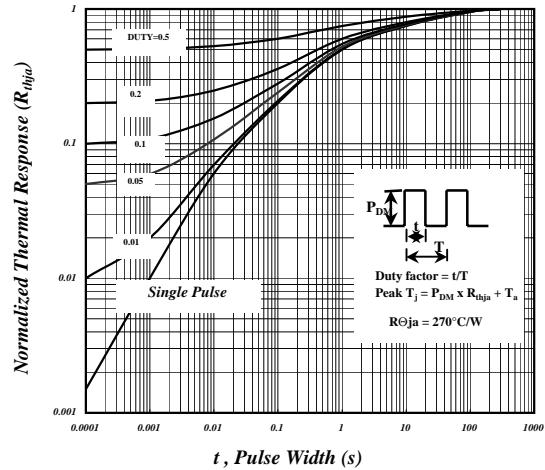

Fig 10. Effective Transient Thermal Impedance

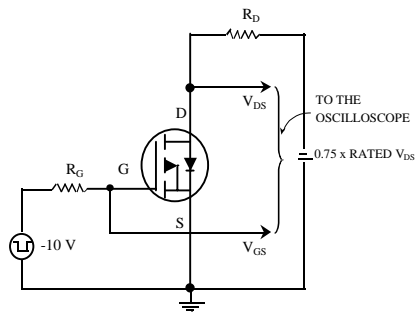

Fig 11. Switching Time Circuit

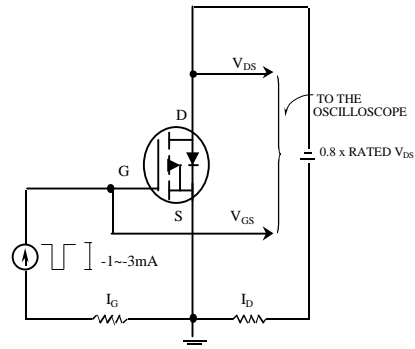

Fig 12. Gate Charge Circuit

Information furnished by Silicon Standard Corporation is believed to be accurate and reliable. However, Silicon Standard Corporation makes no guarantee or warranty, express or implied, as to the reliability, accuracy, timeliness or completeness of such information and assumes no responsibility for its use, or for infringement of any patent or other intellectual property rights of third parties that may result from its use. Silicon Standard reserves the right to make changes as it deems necessary to any products described herein for any reason, including without limitation enhancement in reliability, functionality or design. No license is granted, whether expressly or by implication, in relation to the use of any products described herein or to the use of any information provided herein, under any patent or other intellectual property rights of Silicon Standard Corporation or any third parties.