

## CDBMHT120-HF Thru. CDBMHT1150-HF

Reverse Voltage: 20 to 150 Volts

Forward Current: 1.0 Amp

RoHS Device

Halogen Free

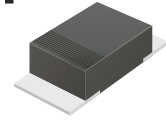

### Features

- Excellent power dissipation offers better reverse leakage current and thermal resistance.
- Low profile package is 40% thinner than standards SOD-123.
- Low power loss, high efficiency.
- High current capability, low forward voltage drop.
- High surge capability.
- Guardring for overvoltage protection.
- Ultra high-speed switching.
- Silicon epitaxial planar chip, metal silicon junction.
- Heat sink bottom.
- Lead-free parts meet environmental standards of MIL-STD-19500/228

### Mechanical data

- Epoxy : UL94-V0 rated flame retardant.
- Case: Molded plastic, SOD-123HT/Mini SMA.
- Terminals: Solderable per MIL-STD-750, method 2026.
- Polarity: Indicated by cathode band.
- Mounting Position : Any.
- Weight: 0.011 grams approx.

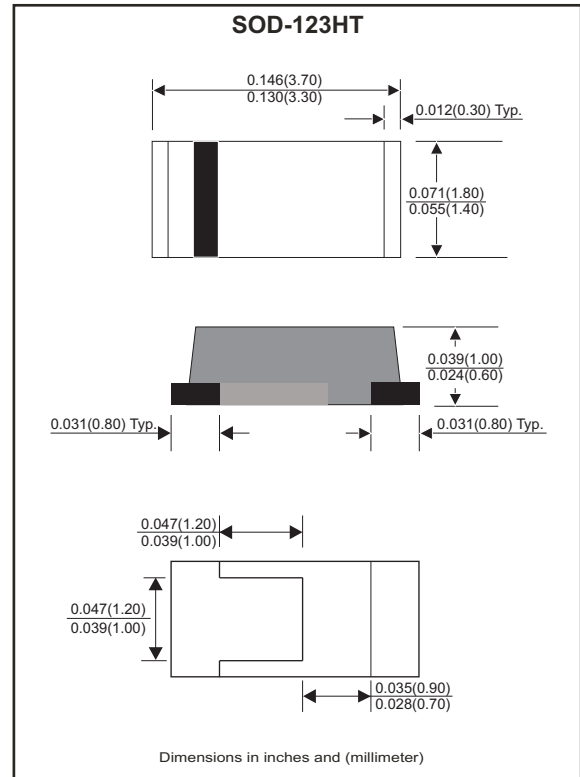

### Electrical Characteristics (at $T_A=25^\circ\text{C}$ unless otherwise noted)

Parameter	Symbol	CDBMH T120-HF	CDBMH T130-HF	CDBMH T140-HF	CDBMH T150-HF	CDBMH T160-HF	CDBMH T180-HF	CDBMH T1100-HF	CDBMH T1150-HF	Unit
Repetitive peak reverse voltage	$V_{RRM}$	20	30	40	50	60	80	100	150	V
Continuous reverse voltage	$V_R$	20	30	40	50	60	80	100	150	V
RMS voltage	$V_{RMS}$	14	21	28	35	42	56	70	105	V
Max. Forward rectified current	$I_o$	1.0								A
Maximum forward voltage at $I_F=1.0A$	$V_F$	0.50			0.70		0.85		0.92	V
Max. Forward surge current, 8.3ms single half sine-wave superimposed on rated load (JEDEC method)	$I_{FSM}$	25								A
Max.Reverse current	$V_R=V_{RRM}$ $T_J=25^\circ\text{C}$	$I_R$								mA
	$V_R=V_{RRM}$ $T_J=100^\circ\text{C}$	$I_R$								
Typ. Thermal resistance	$R_{\theta JC}$	30								$^\circ\text{C/W}$
Typ. Diode Junction capacitance (Note 1)	$C_J$	120								pF
Operating temperature	$T_J$	-55 to +125				-55 to +150				$^\circ\text{C}$
Storage temperature range	$T_{STG}$	-65 to +175								$^\circ\text{C}$

Note : 1.  $F=1\text{MHz}$  and applied 4V DC reverse voltage

REV:A

## Rating and Characteristic Curves (CDBMHT120-HF Thru. CDBMHT1150-HF)

Fig.1- Typical Forward Current Derating Curve

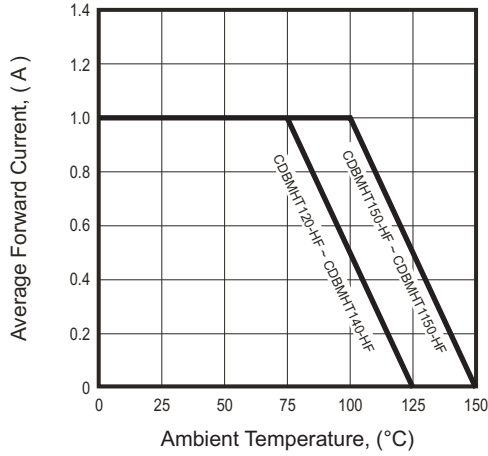

Fig.2- Typical Forward Characteristics

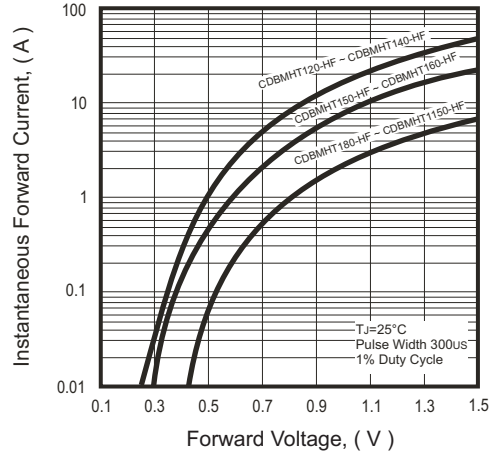

Fig.3- Maximum Non-repetitive Forward Surge Current

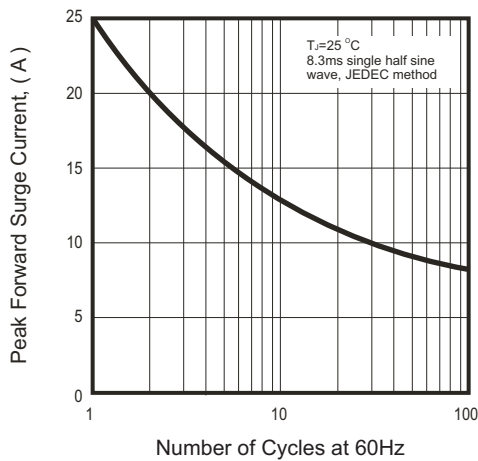

Fig.4- Typical Junction Capacitance

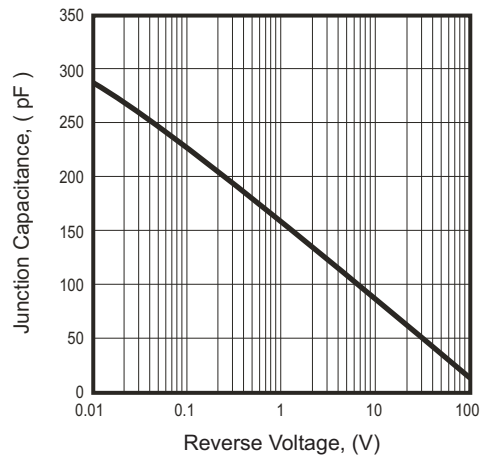
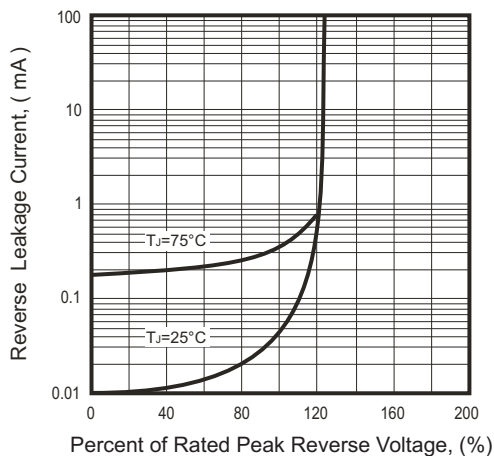
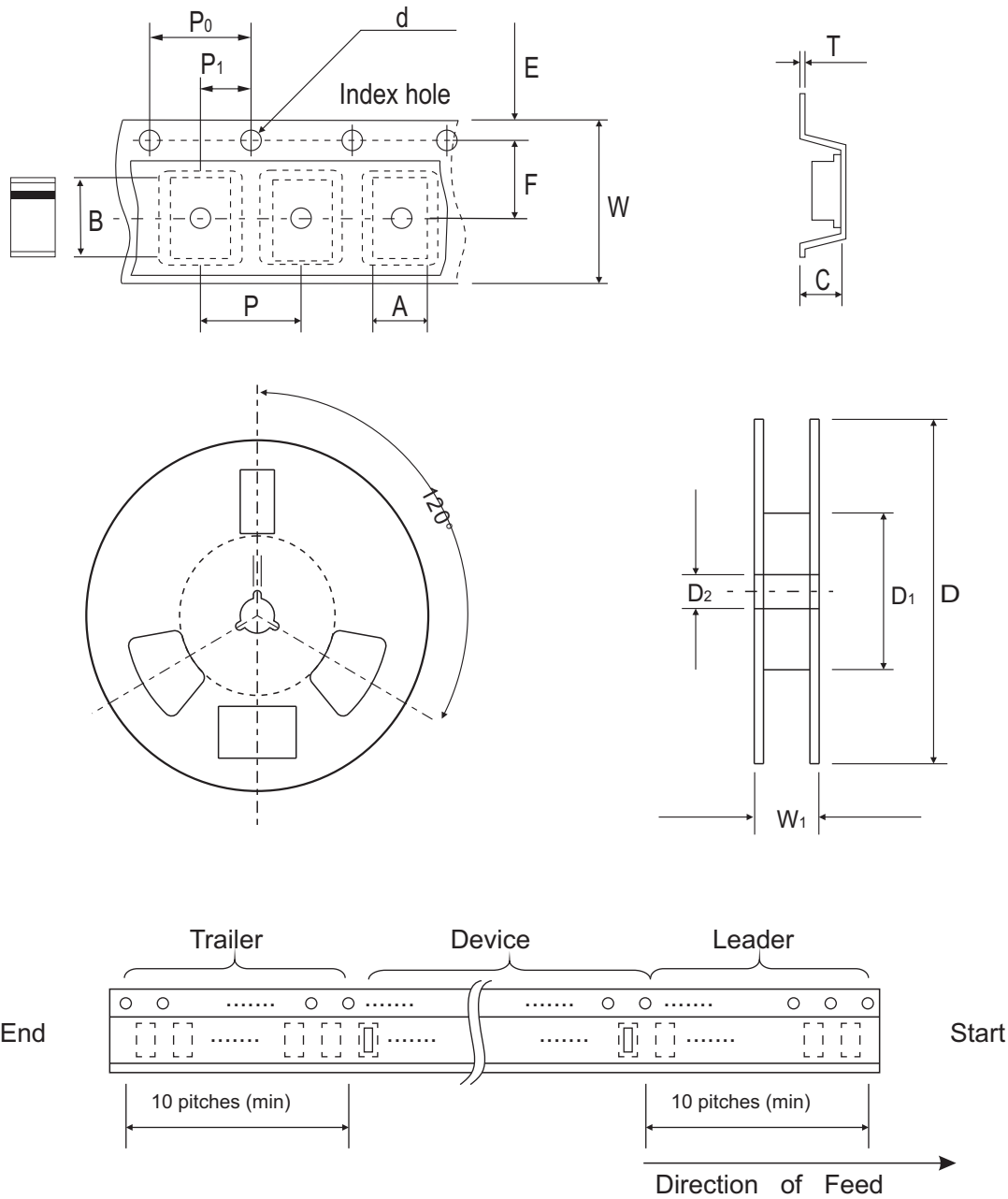

Fig.5- Reverse Characteristics



## Reel Taping Specification



Mini-SMA (SOD-123HT)	SYMBOL	A	B	C	d	D	D1	D2
	(mm)	2.00 ± 0.10	3.85 ± 0.10	1.10 ± 0.10	1.50 ± 0.10	178.00 ± 2.00	62.00 (min)	13.00 ± 0.50
	(inch)	0.079 ± 0.004	0.152 ± 0.004	0.043 ± 0.004	0.059 ± 0.004	7.007 ± 0.079	2.441 (min)	0.512 ± 0.020

Mini-SMA (SOD-123HT)	SYMBOL	E	F	P	P0	P1	T	W	W1
	(mm)	1.75 ± 0.10	3.50 ± 0.10	4.00 ± 0.10	4.00 ± 0.10	2.00 ± 0.10	0.23 ± 0.10	8.00 ± 0.30	11.40 ± 1.00
	(inch)	0.069 ± 0.004	0.138 ± 0.004	0.157 ± 0.004	0.157 ± 0.004	0.079 ± 0.004	0.009 ± 0.04	0.315 ± 0.012	0.449 ± 0.039

## Pinning information

Pin	Simplified outline	Symbol
PIN 1 Cathode PIN 2 Anode		

## Marking Code

Part Number	Marking Code
CDBMHT120-HF	12
CDBMHT130-HF	13
CDBMHT140-HF	14
CDBMHT150-HF	15
CDBMHT160-HF	16
CDBMHT180-HF	18
CDBMHT1100-HF	10
CDBMHT1150-HF	115



xx / xxx = Product type marking code

## Suggested PAD Layout

SIZE	Mini-SMA/SOD-123HT	
	(mm)	(inch)
A	0.80	0.031
B	0.80	0.031
C	1.90	0.075
D	0.90	0.035
E	1.20	0.047

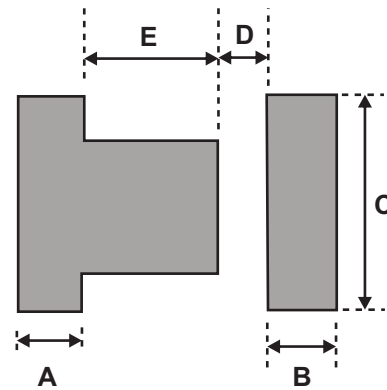

## Standard Packaging

Case Type	REEL PACK	
	REEL ( pcs )	Reel Size (inch)
SOD-123HT	3,000	7