



TAI-SAW TECHNOLOGY CO., LTD.

No. 3, Industrial 2nd Rd., Ping-Chen Industrial District,
Taoyuan, 324, Taiwan, R.O.C.

TEL: 886-3-4690038 FAX: 886-3-4697532

E-mail: tstsales@mail.taisaw.com Web: www.taisaw.com

Approval Sheet For Product Specification

Issued Date:

Product Name: IF SAW Filter 310 MHz (SMD 5.0mmX5.0mm)

TST Parts No.:TB0468A

Customer Parts No.:_____

Company:_____
Division:_____
Approved by : _____
Date:_____

Checked by:_____ Andy Lee

Approval by:_____ Francis Chen

Date:_____ 2007/01/05



TAI-SAW TECHNOLOGY CO., LTD.

No. 3, Industrial 2nd Rd., Ping-Chen Industrial District,
Taoyuan, 324, Taiwan, R.O.C.

TEL: 886-3-4690038 FAX: 886-3-4697532

E-mail: tstsales@mail.taisaw.com Web: www.taisaw.com

IF SAW Filter 310MHz SMD 5x5mm

MODEL NO.: TB0468A

REV.No.1

A. MAXIMUM RATING:

1. Operating Temperature: -10 °C ~ 60 °C
2. Storage Temperature: -40 °C ~ +85 °C
3. Input Power Level: 10dBm

RoHS Compliant
Lead free
Lead-free soldering

B. Characteristics :

1. Ambient Temperature: 23 °C

Characteristics		Value			Note	
		Min.	Typ.	Max.		
Center frequency	F _C MHz	-	310	-	-	
Insertion loss	I.L. dB	-	10.5	14	-	
1 dB Bandwidth	MHz	10	11.5	-	-	
3 dB Bandwidth	MHz	-	14.3	-	-	
Amplitude Ripple (305~315MHz)	dB	-	0.6	1	-	
Phase linearity (305~315MHz)	(p-p) deg	-	3	-	-	
Group Delay Ripple (F _c ±5MHz)	nsec	-	20	100	-	
Attenuation:(Reference level from minimum insertion loss)					dB	
1)	10-205 MHz	dB	45	48	-	-
2)	205-285 MHz	dB	40	43	-	-
3)	335-340 MHz	dB	38	42	-	-
4)	340-360 MHz	dB	35	44	-	-
5)	360-365 MHz	dB	40	44	-	-
6)	365-390 MHz	dB	35	43	-	-
7)	390-485 MHz	dB	39	43	-	-
Source Impedance	Ohm	-	50	-	-	
Load Impedance	Ohm	-	50	-	-	
Temperature C0efficient	ppm/° C	-	-75	-	-	
Substrate Material		-	128 LiNbO3	-	-	

C. Frequency Characteristics :

1. S21 Response

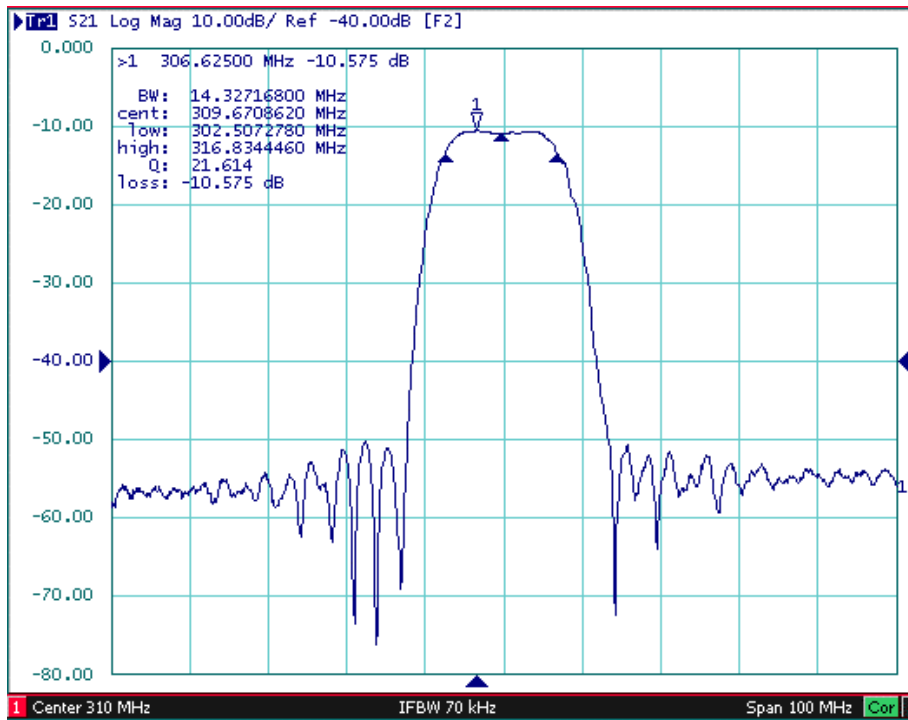

Fig.1 Horizontal : 10MHz/Div Vertical: 10dB/Div

2. Passband Ripple

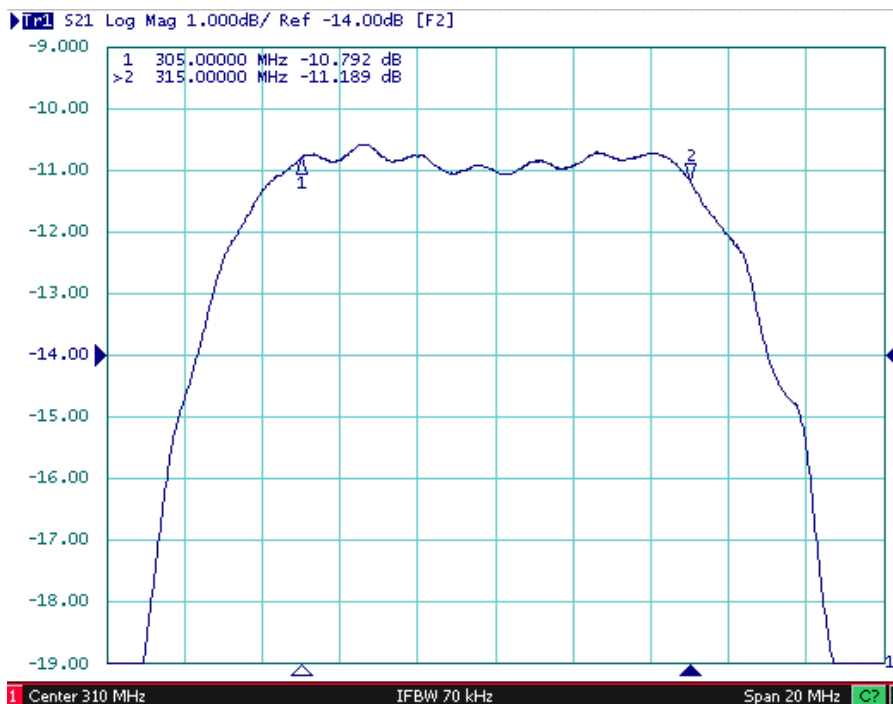

Fig.2 Horizontal : 2MHz/Div Vertical: 1dB/Div

3. Group Delay Ripple

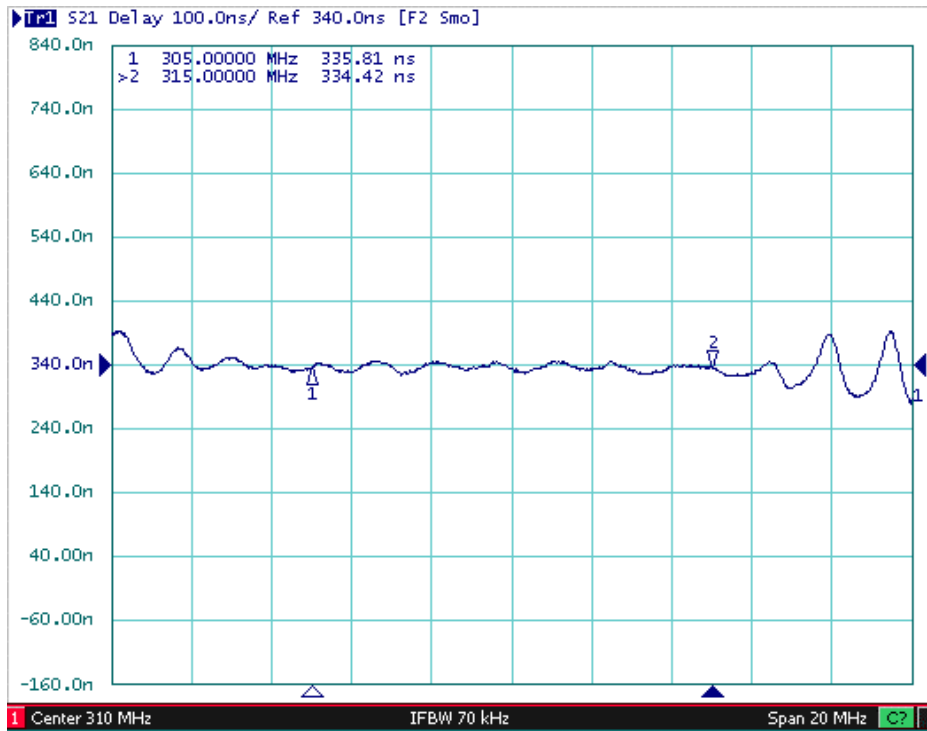

Fig.3 Horizontal : 2MHz/Div Vertical: 100nS/Div

4. Phase linearity

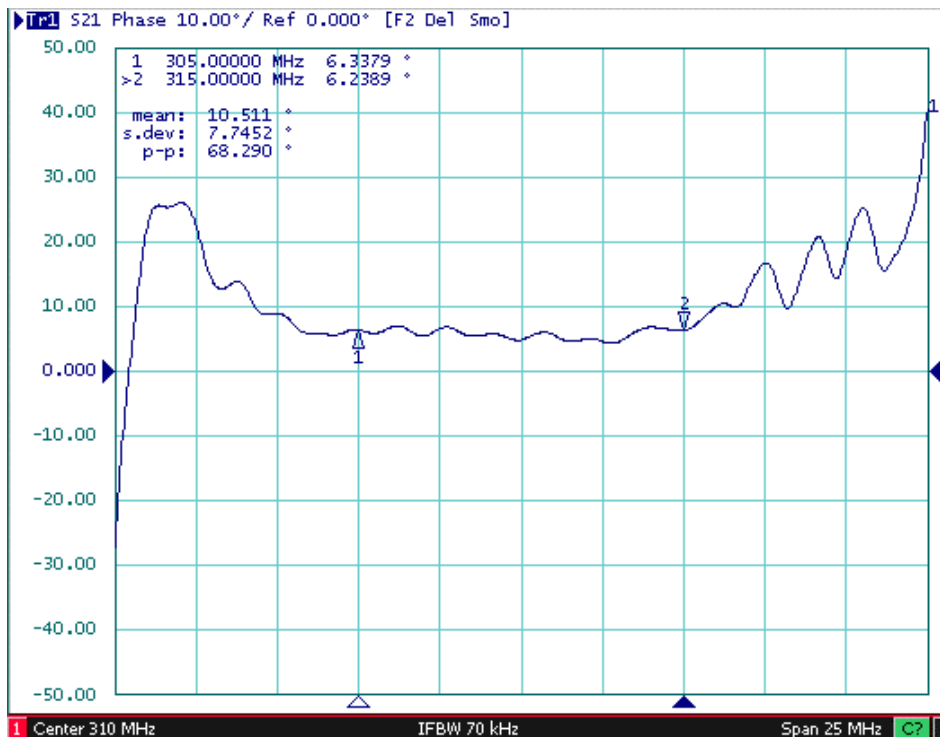
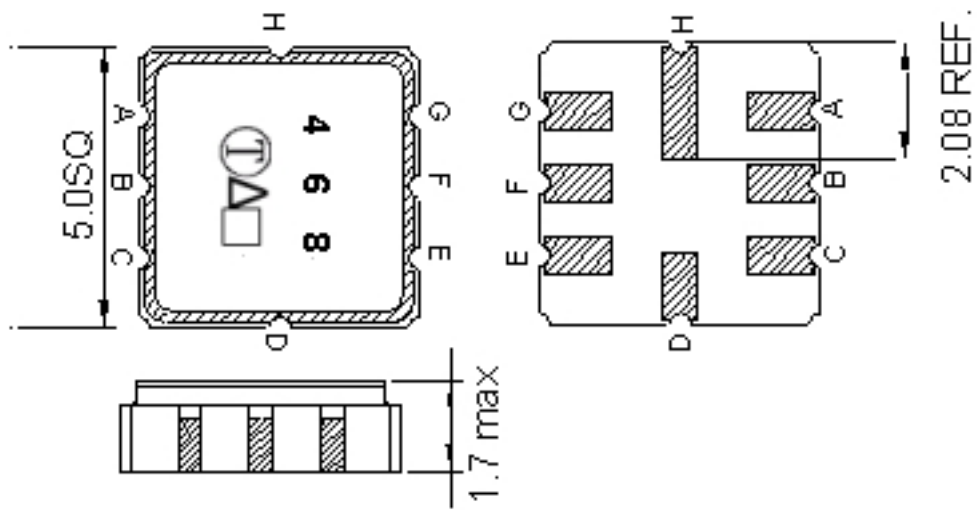

Fig.4 Horizontal : 2.5MHz/Div Vertical: 10 deg/Div

D. Outline Drawing:



Pin B, C : Balanced Input

Pin G, F : Balanced Output

Pin A,C,D,E,H : To be Ground

□ : Week Code (Follow the table from planner each year)

△ : Product / Year Code

Unit : mm

Year	2005 2009	2006 2010	2007 2011	2008 2012
Product Code	B	b	<u>B</u>	<u>b</u>

E. TEST FIXTURE :

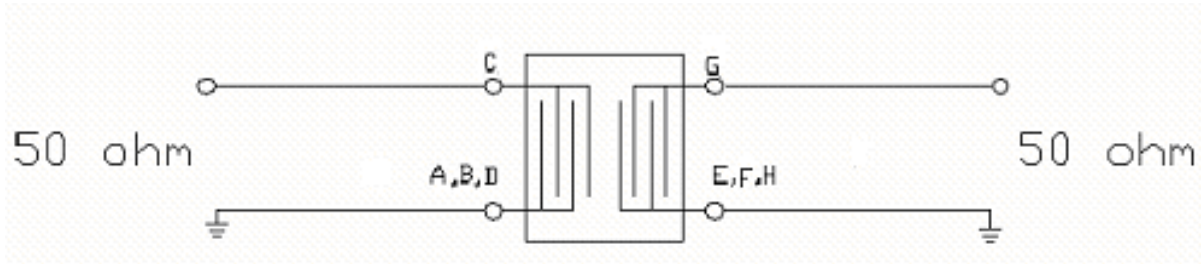

F. PCB FOOTPRINT

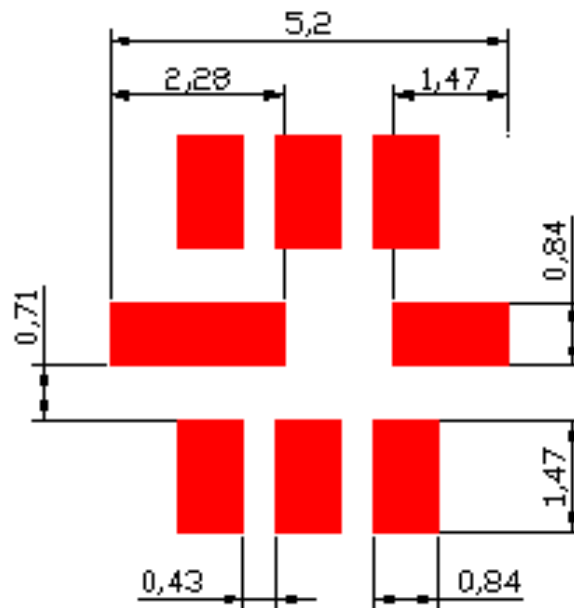

G. PACKING:

1. REEL DIMENSION

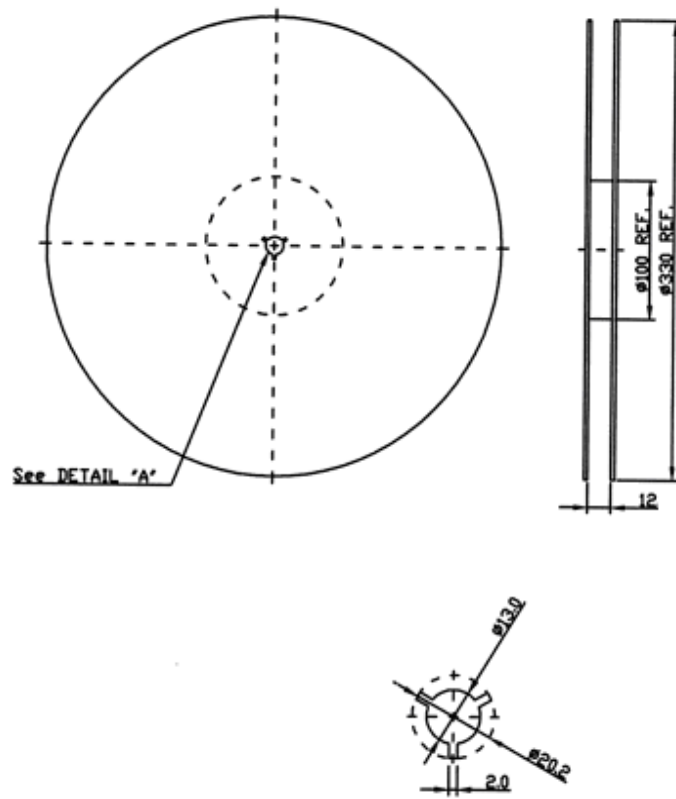

2. TAPE DIMENSION

