

ITEM	CONTENTS	UNIT
DISPLAY TECHNOLOGY	3.5" A-Si TFT ACTIVE-MATRIX TRANSMISSIVE	-
MODULE OUTER DIMENSION	77.9 x 64.6 x 3.3	mm
PIXEL SIZE	73(H) x 219(V)	μm
DOT PITCH	73	μm
	219	μm
EFFECTIVE DISPLAY AREA	70.08 x 52.56	mm
NUMBER OF DOTS	320RGBx240	DOTS
VIEWING DIRECTION	6	CLOCK
COLOR-FILTER-ARRAY	RGB STRIPE	-
BACKLIGHT	LED WHITE BACKLIGHT(PATENTED LED)	-
DRIVER IC	HX8238-A	-
INTERFACE TYPE	DIGITAL 8-BIT SERIAL/24-BIT PARALLEL RGB, CCP601/656	-
NUMBER OF COLORS	16.7M	-
OPERATING TEMPERATURE	-20~70	°C
STORAGE TEMPERATURE	-30~80	°C
WEIGHT	33	g

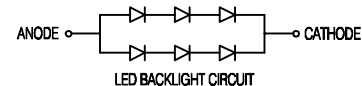

- NOTES:
1. SPECIAL DIMENSION (PPK/CPK DATA NEEDED > 1.67)
  2. CONTROL DIMENSION
  3. ALL UNMARKED DIMENSIONS ARE REFERENCE DIMENSIONS AND NO MEASUREMENT NEEDED.
  4. GREEN/ROHS PRODUCT : YES
  5. BACKLIGHT: WHITE  
LED: 6PCS, IF=30mA, VF=10V.
  6. THE SPECIFICATIONS MAY CHANGE AT ANY TIME WITHOUT NOTICE DUE TO NEW MATERIALS OR PRODUCT IMPROVEMENT.



\*UNLESS OTHERWISE SPECIFIED TOLERANCES PER DECIMAL PRECISION ARE: X=±1 (±0.039), X.X=±0.5 (±0.020), X.XX=±0.25 (±0.010), X.XXX=±0.127 (±0.005). LEAD SIZE=±0.05 (±0.002), LEAD LENGTH=±0.75 (±0.030). MIN.= +DECIMAL PRECISION MAX.= +0.00 -DECIMAL PRECISION

REV.	PART NUMBER LCT-H320240M35W	CONFIDENTIAL INFORMATION THE INFORMATION CONTAINED IN THIS DOCUMENT IS THE PROPERTY OF LUMEX INC. EXCEPT AS SPECIFICALLY AUTHORIZED IN WRITING BY LUMEX INC., THE HOLDER OF THIS DOCUMENT SHALL KEEP ALL INFORMATION CONTAINED HEREIN CONFIDENTIAL AND SHALL PROTECT SAME IN WHOLE OR IN PART FROM DISCLOSURE AND DISSEMINATION TO ALL THIRD PARTIES.	290 E. HELEN ROAD PALATINE, IL 60067-6976 PHONE: +1.847.359.2790 US WEB: www.lumex.com TW WEB: www.lumex.com.tw
3.5" ACTIVE MATRIX FULL COLOR TFT PANEL 6:00 VIEW, LED BACKLIGHT, -20°C TO +70°C OPERATING TEMP.		RELIABILITY NOTE OUR MANY YEARS OF EXPERIENCE DATA ACCUMULATION INDICATE THAT SOLDER HEAT IS A MAJOR CAUSE OF EARLY AND FUTURE FAILURE. PLEASE PAY ATTENTION TO YOUR SOLDERING PROCESS.	DRAWN BY: JUN CHECKED BY: APPROVED BY: DATE: 04.27.09 PAGE: 1 OF 9 SCALE: N/A

INTERFACE PIN CONNECTION

PIN	SYMBOL	FUNCTION	PIN	SYMBOL	FUNCTION
1	A	ANODE OF BACKLIGHT POWER SUPPLY(DC 10V).	31	R1	DIGITAL DATA INPUT.(RED)
2	A	ANODE OF BACKLIGHT POWER SUPPLY(DC 10V).	32	R2	DIGITAL DATA INPUT.(RED)
3	K	CATHODE OF BACKLIGHT SUPPLY.	33	R3	DIGITAL DATA INPUT.(RED)
4	K	CATHODE OF BACKLIGHT SUPPLY.	34	R4	DIGITAL DATA INPUT.(RED)
5	VSS	GROUND.	35	R5	DIGITAL DATA INPUT.(RED)
6	VSS	GROUND.	36	R6	DIGITAL DATA INPUT.(RED)
7	QXH	DATA SEQUENCE CONTROL PIN.	37	R7	DIGITAL DATA INPUT.(RED)
8	POL	POLARITY SIGNAL TO MONITOR VCOM SIGNAL.	38	DEN	DISPLAY ENABLE PIN FROM CONTROLLER.
9	SDO	DATA OUTPUT PIN IN SERIAL MODE.	39	HSYNC	LINE SYNCHRONIZATION SIGNAL.
10	RESB	SYSTEM RESET PIN.	40	VSYS	FRAME SYNCHRONIZATION SIGNAL.
11	CSB	CHIP SELECT PIN OF SERIAL MODE.	41	DOTCLK	DOT-CLOCK SIGNAL AND OSCILLATOR SOURCE.
12	SCK	CLOCK PIN OF SERIAL INTERFACE.	42	SHUT	DISPLAY SHUT DOWN PIN TO PUT THE DRIVER INTO SLEEP MODE.
13	SDI	DATA PIN OF SERIAL INTERFACE.	43	TB	INPUT PIN TO SELECT THE GATE DRIVER SCAN DIRECTION.
14	B0	DIGITAL DATA INPUT.(BLUE)	44	REV	INPUT PIN TO SELECT THE DISPLAY REVISION.
15	B1	DIGITAL DATA INPUT.(BLUE)	45	RL	INPUT PIN TO SELECT THE SOURCE DRIVER DATA SHIFT DIRECTION.
16	B2	DIGITAL DATA INPUT.(BLUE)	46	CM	INPUT PIN TO SELECT 262K-COLOR OR 8-COLOR DISPLAY MODE.
17	B3	DIGITAL DATA INPUT.(BLUE)	47	BGR	INPUT PIN TO SELECT COLOR MAPPING.
18	B4	DIGITAL DATA INPUT.(BLUE)	48	VDDIO	POWER INPUT PIN.
19	B5	DIGITAL DATA INPUT.(BLUE)	49	NC	NOT CONNECT.
20	B6	DIGITAL DATA INPUT.(BLUE)	50	NC	NOT CONNECT.
21	B7	DIGITAL DATA INPUT.(BLUE)			
22	G0	DIGITAL DATA INPUT.(GREEN)			
23	G1	DIGITAL DATA INPUT.(GREEN)			
24	G2	DIGITAL DATA INPUT.(GREEN)			
25	G3	DIGITAL DATA INPUT.(GREEN)			
26	G4	DIGITAL DATA INPUT.(GREEN)			
27	G5	DIGITAL DATA INPUT.(GREEN)			
28	G6	DIGITAL DATA INPUT.(GREEN)			
29	G7	DIGITAL DATA INPUT.(GREEN)			
30	R0	DIGITAL DATA INPUT.(RED)			

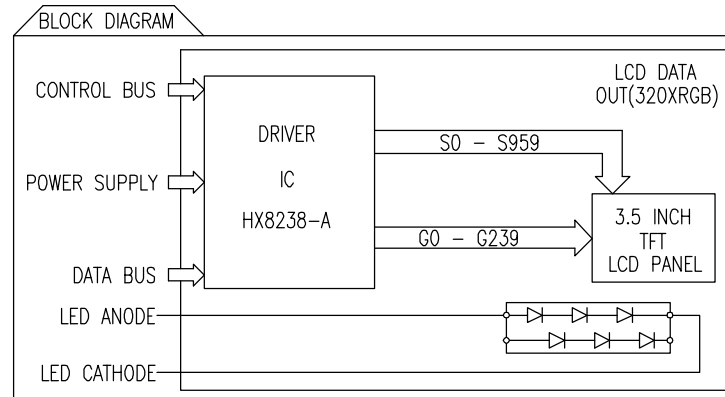

\*UNLESS OTHERWISE SPECIFIED TOLERANCES PER DECIMAL PRECISION ARE: X=±1 (±0.039), X.X=±0.5 (±0.020), X.XX=±0.25 (±0.010), X.XXX=±0.127 (±0.005). LEAD SIZE=±0.05 (±0.002), LEAD LENGTH=±0.75 (±0.030). MIN.= +DECIMAL PRECISION MAX.= +0.00 -DECIMAL PRECISION

REV.	PART NUMBER LCT-H320240M35W	CONFIDENTIAL INFORMATION THE INFORMATION CONTAINED IN THIS DOCUMENT IS THE PROPERTY OF LUMEX INC. EXCEPT AS SPECIFICALLY AUTHORIZED IN WRITING BY LUMEX INC., THE HOLDER OF THIS DOCUMENT SHALL KEEP ALL INFORMATION CONTAINED HEREIN CONFIDENTIAL AND SHALL PROTECT SAME IN WHOLE OR IN PART FROM DISCLOSURE AND DISSEMINATION TO ALL THIRD PARTIES.	<b>LUMEX</b> Creating LED and LCD Solutions Together™	290 E. HELEN ROAD PALATINE, IL 60067-6976 PHONE: +1.847.359.2790 US WEB: www.lumex.com TW WEB: www.lumex.com.tw
3.5" ACTIVE MATRIX FULL COLOR TFT PANEL 6:00 VIEW, LED BACKLIGHT, -20°C TO +70°C OPERATING TEMP.		RELIABILITY NOTE OUR MANY YEARS OF EXPERIENCE DATA ACCUMULATION INDICATE THAT SOLDER HEAT IS A MAJOR CAUSE OF EARLY AND FUTURE FAILURE. PLEASE PAY ATTENTION TO YOUR SOLDERING PROCESS.	DRAWN BY: JN	CHECKED BY: APPROVED BY: DATE: 04.27.09 PAGE: 2 OF 9 SCALE: N/A

ELECTRICAL CHARACTERISTICS

ITEM	SYMBOL	STANDARD VALUE			UNIT	REMARKS
		MIN	TYP.	MAX		
POWER VOLTAGE	VDD	1.8	-	2.5	V	
	VDDIO	1.4	-	3.6	V	
	VIC	2.5orVDDIO	-	3.6	V	
GATE ON VOLTAGE	VGH	9.3	15	16.5	V	
GATE OFF VOLTAGE	VGL	-15	-10	-5.1	V	
INPUT HIGH VOLTAGE	VIH	0.8*VDDIO	-	VDDIO	V	
INPUT LOW VOLTAGE	VIL	Vss	-	0.2*VDDIO	V	
OUTPUT HIGH VOLTAGE	VOH	0.9*VDDIO	-	V <sub>DD</sub>	V	IOH=100uA
OUTPUT LOW VOLTAGE	VOL	Vss	-	0.1*VDDIO	V	IOL=100uA
VCOM HIGHT OUTPUT VOLTAGE	VCOMH	2.5	3.6	4.5	V	
VCOM LOW OUTPUT VOLTAGE	VCOML	-3.0	-2.4	0	V	

BACKLIGHT SPECIFICATIONS

ITEM	SYMBOL	STANDARD VALUE			UNIT	REMARKS
		MIN	TYP.	MAX		
FORWARD VOLTAGE	Vf	8.8	10	10.5	V	If=40mA
ABSOLUTE MAX FORWARD CURRENT	Ifm	35	-	50	mA	
REVERSE VOLTAGE	Vr	10.5	-	15	V	
RESERVE CURRENT	Ir	-	-	200	A	Vr=15V
CHROMACITY COORDINATES	X	0.26	-	0.32	-	
	Y	0.26	-	0.32	-	
LUMINANCE (BLU ONLY)	Lv	2800	3000	-	cd/m <sup>2</sup>	If=40mA
UNIFORMITY	Δ	80	85	-	%	MIN/MAX*100%
REMARK	LED PATENTED					
HALF-BRIGHTNESS LIFE TIME	50000 HOURS					

ABSOLUTE MAXIMUM RATINGS

ITEM	SYMBOL	TEST CONDITION	STANDARD VALUE			UNIT
			MIN	TYP.	MAX	
POWER VOLTAGE	VDDIO	Vss=0	-0.3	-	4.0	V
	VDD	Vss=0	-0.3	-	2.7	V
	VIC	Vss=0	Vss-0.3	-	5.0	V



\*UNLESS OTHERWISE SPECIFIED TOLERANCES PER DECIMAL PRECISION ARE: X=±1 (±0.039), X.X=±0.5 (±0.020), X.XX=±0.25 (±0.010), X.XXX=±0.127 (±0.005). LEAD SIZE=±0.05 (±0.002), LEAD LENGTH=±0.75 (±0.030). MIN= +DECIMAL PRECISION -0.00 MAX.= +0.00 -DECIMAL PRECISION

REV.	PART NUMBER LCT-H320240M35W	<p><b>CONFIDENTIAL INFORMATION</b></p> <p>THE INFORMATION CONTAINED IN THIS DOCUMENT IS THE PROPERTY OF LUMEX INC. EXCEPT AS SPECIFICALLY AUTHORIZED IN WRITING BY LUMEX INC., THE HOLDER OF THIS DOCUMENT SHALL KEEP ALL INFORMATION CONTAINED HEREIN CONFIDENTIAL AND SHALL PROTECT SAME IN WHOLE OR IN PART FROM DISCLOSURE AND DISSEMINATION TO ALL THIRD PARTIES.</p> <p><b>RELIABILITY NOTE</b></p> <p>OUR MANY YEARS OF EXPERIENCE DATA ACCUMULATION INDICATE THAT SOLDER HEAT IS A MAJOR CAUSE OF EARLY AND FUTURE FAILURE. PLEASE PAY ATTENTION TO YOUR SOLDERING PROCESS.</p>	<p>290 E. HELEN ROAD PALATINE, IL 60067-6976 PHONE: +1.847.359.2790 US WEB: www.lumex.com TW WEB: www.lumex.com.tw</p>
3.5" ACTIVE MATRIX FULL COLOR TFT PANEL 6:00 VIEW, LED BACKLIGHT, -20°C TO +70°C OPERATING TEMP.		<p>DRAWN BY: JN</p>	<p>CHECKED BY:</p> <p>APPROVED BY:</p> <p>DATE: 04.27.09 PAGE: 3 OF 9 SCALE: N/A</p>

OPTICAL CHARACTERISTICS		SYMBOL	CONDITION	STANDARD VALUE			UNIT	NOTE
ITEM				MIN	TYP.	MAX		
RESPONSE TIME	Tr	±0°C	-	15	20	V	1	
	Tf		-	35	50			
CONTRAST RATIO	CR	±0°C	150	250	-	V	2	
VIEWING ANGLE (CR±10)	RIGHT	±0°C	-	45	-	DEG	3	
	LEFT		-	45	-			
	UPPER		-	15	-			
	LOWER		-	35	-			
LUMINANCE OF WHITE (CENTER POINT OF LCM)	L	-	200	220	-	Cd/m <sup>2</sup>	5	
COLOR CROMACITY (CIE1931)  "SIMULATION DATA REFERENCE ONLY"	Rx	±0°C	0.610	0.640	0.670	-	"SIMULATION REFERENCE ONLY"	
	Ry		0.314	0.344	0.374	-		
	Gx		0.268	0.298	0.328	-		
	Gy		0.553	0.583	0.613	-		
	Bx		0.102	0.132	0.162	-		
	By		0.107	0.137	0.167	-		
	Wx		0.282	0.312	0.342	-		
	Wy		0.319	0.349	0.379	-		
OPTIMUM VIEWING DIRECTION	6 O'CLOCK						-	

NOTE(2): DEFINITION OF CONTRAST RATIO  
CR=BRIGHTNESS AT ALL PIXELS "WHITE" / BRIGHTNESS AT ALL PIXELS "BLACK"

NOTE(4): MEASURED AT CENTER POINT VERTICALLY WITH BACKLIGHT ON."

NOTE(5): AFTER STABILIZING AND LEAVING THE PANEL ALONE AT GIVEN TEMPERATURE FOR 30MIN, THE MEASUREMENT SHOULD BE EXECUTED. MEASUREMENT SHOULD BE EXECUTED IN STABLE, WINDLESS, AND DARK ROOM 30 MINS AFTER LIGHTING THE BACK-LIGHT. THIS SHOULD BE MEASURED IN THE CENTER OF SCREEN. ENVIRONMENT CONDITION: Ta=25±2°C BACK-LIGHT ON CONDITION

NOTE(3): DEFINITION OF VIEWING ANGLE

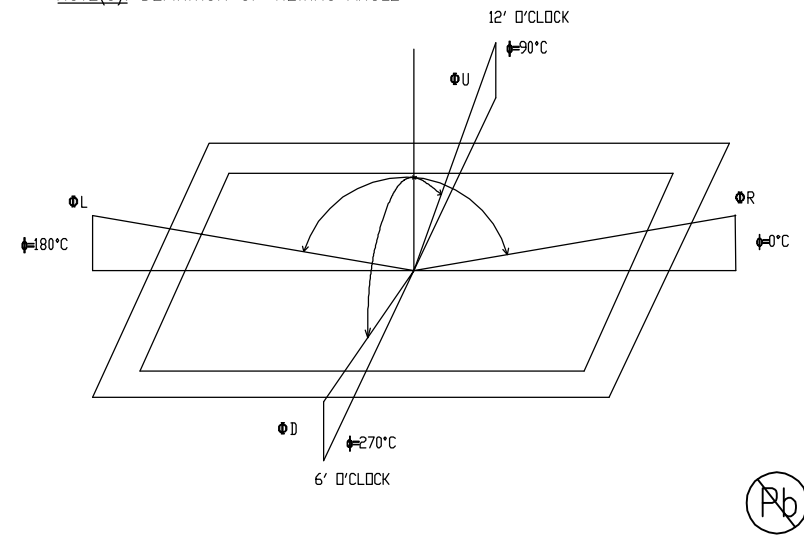

NOTE(1): DEFINITION OF RESPONSE TIME

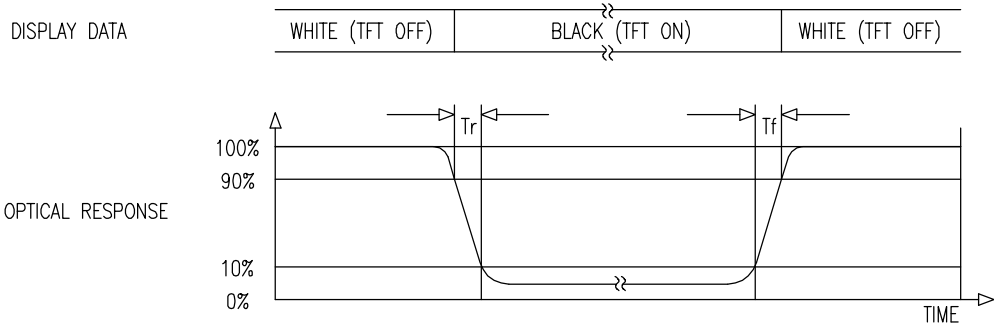

\*UNLESS OTHERWISE SPECIFIED TOLERANCES PER DECIMAL PRECISION ARE: X=±1 (±0.039), X.X=±0.5 (±0.020), X.XX=±0.25 (±0.010), X.XXX=±0.127 (±0.005). LEAD SIZE=±0.05 (±0.002), LEAD LENGTH=±0.75 (±0.030). MIN.= +DECIMAL PRECISION -0.00 MAX.= +0.00 -DECIMAL PRECISION

UNCONTROLLED DOCUMENT

REV.	PART NUMBER LCT-H320240M35W	<p><b>CONFIDENTIAL INFORMATION</b> THE INFORMATION CONTAINED IN THIS DOCUMENT IS THE PROPERTY OF LUMEX INC. EXCEPT AS SPECIFICALLY AUTHORIZED IN WRITING BY LUMEX INC., THE HOLDER OF THIS DOCUMENT SHALL KEEP ALL INFORMATION CONTAINED HEREIN CONFIDENTIAL AND SHALL PROTECT SAME IN WHOLE OR IN PART FROM DISCLOSURE AND DISSEMINATION TO ALL THIRD PARTIES.</p> <p>RELIABILITY NOTE OUR MANY YEARS OF EXPERIENCE DATA ACCUMULATION INDICATE THAT SOLDER HEAT IS A MAJOR CAUSE OF EARLY AND FUTURE FAILURE. PLEASE PAY ATTENTION TO YOUR SOLDERING PROCESS.</p>		290 E. HELEN ROAD PALATINE, IL 60067-6976 PHONE: +1.847.359.2790 US WEB: www.lumex.com TW WEB: www.lumex.com.tw	
	3.5" ACTIVE MATRIX FULL COLOR TFT PANEL 6:00 VIEW, LED BACKLIGHT, -20°C TO +70°C OPERATING TEMP.			DRAWN BY: JN	CHECKED BY:

UNCONTROLLED DOCUMENT

PART NUMBER  
LCT-H320240M35W

REV.

STANDARD SPECIFICATION FOR REABILITY

STANDARD SPECIFICATION OF REABILITY TEST

NO	TEST ITEM	CONTENT OF TEST	TEST CONDITION	APPLICABLE STANDARD
1	HIGH TEMPERATURE STORAGE	ENDURANCE TEST APPLYING THE HIGH STORAGE TEMPERATURE FOR A LONG TIME.	80+/-3°C 240HRS	- - - -
2	LOW TEMPERATURE STORAGE	ENDURANCE TEST APPLYING THE LOW STORAGE TEMPERATURE FOR A LONG TIME.	-30+/-3°C 240HRS	- - - -
3	HIGH TEMPERATURE OPERATION	ENDURANCE TEST APPLYING THE ELECTRIC STRESS (VOLTAGE & CURRENT) AND THE THERMAL STRESS TO THE ELEMENT FOR A LONG TIME.	70+/-3°C 240HRS	- - - -
4	LOW TEMPERATURE OPERATION	ENDURANCE TEST APPLYING THE ELECTRIC STRESS UNDER LOW TEMPERATURE FOR A LONG TIME.	-20+/-3°C 240HRS	- - - -
5	HIGH TEMPERATURE/HUMIDITY OPERATION	ENDURANCE TEST APPLYING THE ELECTRIC STRESS (VOLTAGE & CURRENT) AND TEMPERATURE / HUMIDITY STRESS TO THE ELEMENT FOR A LONG TIME.	40°C, 90%RH 120HRS	MIL-202E-103B JIS-C5023
6	TEMPERATURE CYCLE	ENDURANCE TEST APPLYING THE LOW AND HIGH TEMPERATURE CYCLE. $\begin{array}{c} -20^{\circ}\text{C} \rightleftarrows 25^{\circ}\text{C} \rightleftarrows 70^{\circ}\text{C} \\ \leftarrow 30 \text{ MIN} \quad \leftarrow 5 \text{ MIN} \quad \leftarrow 30 \text{ MIN} \rightarrow \\ \text{1 CYCLE} \end{array}$	-20°C/ 70°C 10 CYCLES	- - - -
MECHANICAL TEST				
7	DROP TEST	ENDURANCE TEST APPLYING THE DROP DURING TRANSPORTATION.	PACKED,100cm FREE FALL(6 SLIDES, 1 CORNER, 3 EDGES)	- - - -

REMARKS:

1. FOR OPERATION TEST, ABOVE SPECIFICATION IS APPLICABLE WHEN TEST PATTERN IS CHANGING DURING ENTIRE OPERATION TEST.
2. INSPECTIONS AFTER RELIABILITY TESTS ARE PERFORMED WHEN THE DISPLAY TEMPERATURE RESUMES BACK TO ROOM TEMPERATURE.
3. IT IS A NORMAL CHARACTERISTIC THAT SOME DISPLAY ABNORMALITY CAN BE SEEN DURING REABILITY TEST. IF THE DISPLAY ABNORMALITY CAN RESUME BACK TO NORMAL CONDITION AT ROOM TEMPERATURE WITHIN 24 HOURS, THERE IS NO PERMANENT DESTRUCTION OVER THE DISPLAY. THE DISPLAY STILL POSSESSES ITS FUNCTIONALITY AFTER REABILITY TESTS.



UNCONTROLLED DOCUMENT

\*UNLESS OTHERWISE SPECIFIED TOLERANCES PER DECIMAL PRECISION ARE: X=±1 (±0.039), X.X=±0.5 (±0.020), X.XX=±0.25 (±0.010), X.XXX=±0.127 (±0.005). LEAD SIZE=±0.05 (±0.002), LEAD LENGTH=±0.75 (±0.030). MIN.= +DECIMAL PRECISION MAX.= +0.00 -DECIMAL PRECISION

REV.	PART NUMBER LCT-H320240M35W	CONFIDENTIAL INFORMATION THE INFORMATION CONTAINED IN THIS DOCUMENT IS THE PROPERTY OF LUMEX INC. EXCEPT AS SPECIFICALLY AUTHORIZED IN WRITING BY LUMEX INC., THE HOLDER OF THIS DOCUMENT SHALL KEEP ALL INFORMATION CONTAINED HEREIN CONFIDENTIAL AND SHALL PROTECT SAME IN WHOLE OR IN PART FROM DISCLOSURE AND DISSEMINATION TO ALL THIRD PARTIES.	 290 E. HELEN ROAD PALATINE, IL 60067-6976 PHONE: +1.847.359.2790 US WEB: www.lumex.com TW WEB: www.lumex.com.tw
3.5" ACTIVE MATRIX FULL COLOR TFT PANEL 6:00 VIEW, LED BACKLIGHT, -20°C TO +70°C OPERATING TEMP.		RELIABILITY NOTE OUR MANY YEARS OF EXPERIENCE DATA ACCUMULATION INDICATE THAT SOLDER HEAT IS A MAJOR CAUSE OF EARLY AND FUTURE FAILURE. PLEASE PAY ATTENTION TO YOUR SOLDERING PROCESS.	DRAWN BY: JN CHECKED BY: APPROVED BY: DATE: 04.27.09 PAGE: 5 OF 9 SCALE: N/A

UNCONTROLLED DOCUMENT

PART NUMBER  
LCT-H320240M35W

REV.

QUALITY ASSURANCE

ACCEPTABLE QUALITY LEVEL (AQL)

EACH LOT SHOULD SATISFY THE QUALITY LEVEL DEFINED AS FOLLOWS:

- A. INSPECTION METHOD: MIL-SDT-105E LEVEL II NORMAL ONE TIME SAMPLING.
- B. AQL LEVEL.

CATEGORY	AQL	DEFINITION
MAJOR	0.25%	FUNCTIONAL DEFECTIVE AS PRODUCT.
MINOR	1.00%	SATISFY ALL FUNCTIONS AS PRODUCT BUT NOT SATISFY COSMETIC STANDARD.

COSMETIC SCREENING CRITERIA

NO	DEFECT	JUDGMENT CRITERIA	CATEGORY		
1	SPOTS/DUST /BUBBLE (ROUND TYPE)	SIZE, D(mm) D ≤ 0.15 0.15 < D ≤ 0.20 D > 0.20	ACCEPTABLE QUANTITY IN ACTIVE AREA DISREGARD 3 0	MINOR	
2	DUST/ SCRATCHES/ BLACK STREAK (LINE TYPE)	WIDTH, W(mm) W ≤ 0.02 W ≤ 0.03 W ≤ 0.05 W > 0.05	LENGTH, L(mm) L ≤ 1.0 L ≤ 2.0 DISREGARD DISREGARD 3 0	ACCEPTABLE QUANTITY IN ACTIVE AREA DISREGARD DISREGARD DISREGARD	MINOR
3	ALLOWABLE DENSITY	ABOVE DEFECTS SHOULD BE SEPARATED MORE THAN 5mm EACH OTHER.		MINOR	
4	RAINBOW	OBVIOUS UNVEN COLOR (RAINBOW) SHALL NOT BE NOTICEABLE.		MINOR	
5	DISPLAY CONDITION	DIM DISPLAY ON THE PATTERNS, EXTRA PATTERN AND SHORT CIRCUIT ARE NOT ACCEPTABLE.		MAJOR	
6	NO DISPLAY OR MISSING DISPLAY	THE PATTERNS OF DISPLAY SHALL LIGHT UP AS REQUIRED. NO DISPLAY OR MISSING DISPLAY ARE NOT ACCEPTABLE.		MAJOR	

NOTE: D= (LONG LENGTH + SORTH LENGTH)/2

FAILURE JUDGMENT CRITERIA

AFTER REABILITY TEST ABOVE, TEST SAMPLE SHALL BE LET RUN TO ROOM TEMPERATURE AND HUMIDITY AT LEAST 4 HOURS BEFORE FINAL TESTS ARE CARRIED OUT.

CRITERION ITEM	FAILURE JUDGMENT CRITERIA
ELECTRICAL CHARACTERISTIC	ELECTRICAL SHORT AND OPEN.
MECHANICAL CHARACTERISTIC	OUT OF MECHANICAL SPECIFICATION.
OPTICAL CHARACTERISTIC	OUT OF APPERANCE STANDARD.



UNCONTROLLED DOCUMENT

\*UNLESS OTHERWISE SPECIFIED TOLERANCES PER DECIMAL PRECISION ARE: X=±1 (±0.039), X.X=±0.5 (±0.020), X.XX=±0.25 (±0.010), X.XXX=±0.127 (±0.005). LEAD SIZE=±0.05 (±0.002), LEAD LENGTH=±0.75 (±0.030). MIN.= +DECIMAL PRECISION -0.00 MAX.= +0.00 -DECIMAL PRECISION

REV.	PART NUMBER LCT-H320240M35W	CONFIDENTIAL INFORMATION THE INFORMATION CONTAINED IN THIS DOCUMENT IS THE PROPERTY OF LUMEX INC. EXCEPT AS SPECIFICALLY AUTHORIZED IN WRITING BY LUMEX INC., THE HOLDER OF THIS DOCUMENT SHALL KEEP ALL INFORMATION CONTAINED HEREIN CONFIDENTIAL AND SHALL PROTECT SAME IN WHOLE OR IN PART FROM DISCLOSURE AND DISSEMINATION TO ALL THIRD PARTIES.	 290 E. HELEN ROAD PALATINE, IL 60067-6976 PHONE: +1.847.359.2790 US WEB: www.lumex.com TW WEB: www.lumex.com.tw
3.5" ACTIVE MATRIX FULL COLOR TFT PANEL 6:00 VIEW, LED BACKLIGHT, -20°C TO +70°C OPERATING TEMP.		RELIABILITY NOTE OUR MANY YEARS OF EXPERIENCE DATA ACCUMULATION INDICATE THAT SOLDER HEAT IS A MAJOR CAUSE OF EARLY AND FUTURE FAILURE. PLEASE PAY ATTENTION TO YOUR SOLDERING PROCESS.	DRAWN BY: JN CHECKED BY: APPROVED BY: DATE: 04.27.09 PAGE: 6 OF 9 SCALE: N/A

## PRECAUTIONS FOR USING LCD MODULE

PART NUMBER  
**LCT-H320240M35W**

REV.

### HANDLING PRECAUTIONS

1. THE DISPLAY PANEL IS MADE OF GLASS AND POLARIZER. DO NOT SUBJECT IT TO MECHANICAL SHOCK BY DROPPING OR IMPACT WHICH MAY CAUSE CHIPPING ESPECIALLY ON THE EDGES.
2. DO NOT TOUCH, PUSH OR RUB THE EXPOSED POLARIZERS WITH ANYTHING HARDER THAN AN HB PENCIL LEAD (GLASS, TWEEZERS, ETC.). THE POLARIZER COVERING THE DISPLAY SURFACE OF THE LCD MODULE IS SOFT AND EASILY SCRATCHED. HANDLE THIS POLARIZER CAREFULLY.
3. IF THE DISPLAY SURFACE BECOMES CONTAMINATED, BREATHE ON THE SURFACE AND GENTLY WIPE IT WITH A SOFT DRY CLOTH. IF IT IS HEAVILY CONTAMINATED, MOISTEN CLOTH WITH ISOPROPYL ALCOHOL OR ETHYL ALCOHOL. AVOID USING SOLVENTS LIKE ACETONE (KETENE), WATER, TOLUENE, ETHANOL TO CLEAN THE POLARIZER SURFACE.
4. PLEASE KEEP THE TEMPERATURE WITHIN SPECIFIED RANGE FOR USE AND STORAGE. POLARIZATION DEGRADATION, BUBBLE GENERATION OR POLARIZER PEEL-OFF MAY OCCUR WITH HIGH TEMPERATURE AND HIGH HUMIDITY.
5. DO NOT APPLY EXCESSIVE FORCE TO THE DISPLAY SURFACE OR THE ADJOINING AREAS SINCE THIS MAY CAUSE THE COLOR TONE TO VARY.
6. INSTALL THE LCD MODULE BY USING THE MOUNTING HOLES. WHEN MOUNTING THE LCD MODULE MAKE SURE IT IS FREE OF TWISTING, WARPING AND DISTORTION.
7. EXERCISE CARE TO MINIMIZE CORROSION OF THE ELECTRODE. CORROSION OF THE ELECTRODES IS ACCELERATED BY WATER DROPLETS, MOISTURE CONDENSATION OR A CURRENT FLOW IN A HIGH-HUMIDITY ENVIRONMENT.
8. NC TERMINAL SHOULD BE OPEN. DO NOT CONNECT ANYTHING.
9. IF THE LOGIC CIRCUIT POWER IS OFF, DO NOT APPLY THE INPUT SIGNALS.
10. AVOID CONTACTING OIL AND FATS.
11. CONDENSATION ON THE SURFACE AND CONTACT WITH TERMINALS DUE TO COLD WILL DAMAGE, STAIN OR DIRTY THE POLARIZERS. AFTER PRODUCTS ARE TESTED AT LOW TEMPERATURE THEY MUST BE WARMED UP IN A CONTAINER BEFORE COMING IN CONTACT WITH ROOM TEMPERATURE AIR.
12. WIPE OFF SALIVA OR WATER DROPS IMMEDIATELY, CONTACT WITH WATER OVER A LONG PERIOD OF TIME MAY CAUSE DEFORMATION OR COLOR FADING.

### ELECTRO-STATIC DISCHARGE CONTROL

1. SINCE THIS MODULE USES A CMOS LSI, THE SAME CAREFUL ATTENTION SHOULD BE PAID TO ELECTROSTATIC DISCHARGE AS FOR AN ORDINARY CMOS IC.
2. BE SURE TO GROUND THE BODY WHEN HANDLING THE LCD MODULES. TOOLS REQUIRED FOR ASSEMBLING, SUCH AS SOLDERING IRONS, MUST BE PROPERLY GROUNDED.
3. TO REDUCE THE AMOUNT OF STATIC ELECTRICITY GENERATED, DO NOT CONDUCT ASSEMBLING AND OTHER WORK UNDER DRY CONDITIONS. TO REDUCE THE GENERATION OF STATIC ELECTRICITY, BE CAREFUL THAT THE AIR IN THE WORK AREA IS NOT TOO DRY. A RELATIVE HUMIDITY OF 50%-60% IS RECOMMENDED.
4. THE LCD MODULE IS COATED WITH A FILM TO PROTECT THE DISPLAY SURFACE. EXERCISE CARE WHEN PEELING OFF THIS PROTECTIVE FILM SINCE STATIC ELECTRICITY MAY BE GENERATED.
5. WHEN SOLDERING THE TERMINAL OF LCM, MAKE CERTAIN THE AC POWER SOURCE FOR THE SOLDERING IRON DOES NOT LEAK.

### PRECAUTION OF SOLDERING TO THE LCM

1. OBSERVE THE FOLLOWING WHEN SOLDERING LEAD WIRE, CONNECTOR CABLE AND ETC. TO THE LCD MODULE.
  - SOLDERING IRON TEMPERATURE: 300~350°C.
  - SOLDERING TIME: ≤3 SEC.
  - SOLDER: EUTECTIC SOLDER.
2. ABOVE IS A RECOMMENDED APPROACH. DUE TO DIFFERENT SOLDER COMPOSITION AND PROCESSING METHOD, IT IS RECOMMENDED THAT CUSTOMER TO STUDY AND FINE TUNING THEIR SOLDERING PROCESS PARAMETERS ACCORDINGLY.
3. IF SOLDERING FLUX IS USED, BE SURE TO REMOVE ANY REMAINING FLUX AFTER FINISHING TO SOLDERING OPERATION. (THIS DOES NOT APPLY IN THE CASE OF A NON-HALOGEN TYPE OF FLUX.) IT IS RECOMMENDED THAT YOU PROTECT THE LCD SURFACE WITH A COVER DURING SOLDERING TO PREVENT ANY DAMAGE DUE TO FLUX SPATTERS.

### PRECAUTION FOR OPERATION

1. VIEWING ANGLE VARIES WITH THE CHANGE OF LIQUID CRYSTAL DRIVING VOLTAGE (Vo). ADJUST Vo TO SHOW THE BEST CONTRAST.
2. DRIVING THE LCD IN THE VOLTAGE ABOVE THE LIMIT SHORTENS ITS LIFETIME.
3. RESPONSE TIME IS GREATLY DELAYED AT TEMPERATURE BELOW THE OPERATING TEMPERATURE RANGE. HOWEVER, IT WILL RECOVER WHEN IT RETURNS TO THE SPECIFIED TEMPERATURE RANGE.
4. IF THE DISPLAY AREA IS PUSHED HARD DURING OPERATION, THE DISPLAY WILL BECOME ABNORMAL. HOWEVER, IT WILL RETURN TO NORMAL IF IT IS TURNED OFF AND THEN BACK ON.
5. WHEN TURNING THE POWER ON, INPUT EACH SIGNAL AFTER THE POSITIVE/NEGATIVE VOLTAGE BECOMES STABLE (BELOW FIGURE IS A GENERAL ILLUSTRATION WHERE TYPICAL VALUE DEPENDS ON INDIVIDUAL PRODUCT DESIGN).

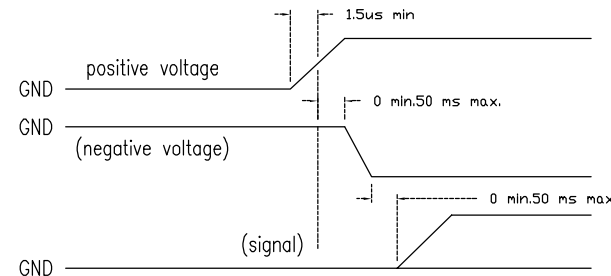

\*UNLESS OTHERWISE SPECIFIED TOLERANCES PER DECIMAL PRECISION ARE: X=±1 (±0.039), X.X=±0.5 (±0.020), X.XX=±0.25 (±0.010), X.XXX=±0.127 (±0.005). LEAD SIZE=±0.05 (±0.002), LEAD LENGTH=±0.75 (±0.030). MIN.= +DECIMAL PRECISION -0.00 MAX.= +0.00 -DECIMAL PRECISION

# UNCONTROLLED DOCUMENT

REV.	PART NUMBER <b>LCT-H320240M35W</b>	<b>CONFIDENTIAL INFORMATION</b> THE INFORMATION CONTAINED IN THIS DOCUMENT IS THE PROPERTY OF LUMEX INC. EXCEPT AS SPECIFICALLY AUTHORIZED IN WRITING BY LUMEX INC., THE HOLDER OF THIS DOCUMENT SHALL KEEP ALL INFORMATION CONTAINED HEREIN CONFIDENTIAL AND SHALL PROTECT SAME IN WHOLE OR IN PART FROM DISCLOSURE AND DISSEMINATION TO ALL THIRD PARTIES.		<b>LUMEX</b> Creating LED and LCD Solutions Together™		290 E. HELEN ROAD PALATINE, IL 60067-6976 PHONE: +1.847.359.2790 US WEB: www.lumex.com TW WEB: www.lumex.com.tw	
3.5" ACTIVE MATRIX FULL COLOR TFT PANEL		<b>RELIABILITY NOTE</b> OUR MANY YEARS OF EXPERIENCE DATA ACCUMULATION INDICATE THAT SOLDER HEAT IS A MAJOR CAUSE OF EARLY AND FUTURE FAILURE. PLEASE PAY ATTENTION TO YOUR SOLDERING PROCESS.		DRAWN BY:	CHECKED BY:	APPROVED BY:	DATE: 04.27.09
6:00 VIEW, LED BACKLIGHT, -20°C TO +70°C OPERATING TEMP.		JN					PAGE: 7 OF 9 SCALE: N/A

UNCONTROLLED DOCUMENT

PART NUMBER  
LCT-H320240M35W

REV.

RoHS COMPLIANT PRODUCT

- |   |                   |
|---|-------------------|
| 1. CADMIUM AND CADMIUM COMPOUNDS          | LESS THAN 100PPM  |
| 2. HEXAVALENT CHROMIUM COMPOUNDS          | LESS THAN 1000PPM |
| 3. LEAD AND LEAD COMPOUNDS                | LESS THAN 1000PPM |
| 4. MERCURY AND MERCURY COPMPOUNDS         | LESS THAN 1000PPM |
| 5. POLYBROMINATED BIPHENYLS (PBBs)        | LESS THAN 1000PPM |
| 6. POLYBROMINATED DIPHENYL ETHERS (PBDEs) | LESS THAN 1000PPM |

PACKAGING STANDARD

PRODUCT NO.	LCT-H320240M35W	RELEASE DATE	2009
PRODUCT NAME.	TFT MODULE	PREPARE BY:	
QUANTITY/ EACH BOX	168 PCS.	BOX MATERIAL	PAPER CARTON
OUTER CARTON BOX SIZE	465mm x 405mm x 305mm	BOX TYPE	NEW
QUANTITY/ INNER BOX	12 X 7 X 2 = 168 PCS.	WEIGHT	8.6 KG
QUANTITY/ OUTER BOX			

THERE ARE 12 PCS LCD PER EACH ANTI-STATIC PLASTIC PLATE.  
THERE ARE 7 LAYER PLASTIC PLATES PER EACH INNER CARTON BOX.  
THERE ARE 2 INNER CARTON BOX PER EACH OUTER CARTON BOX.

STORAGE

1. WHEN STORING LCDS AS SPARES FOR SOME YEARS, THE FOLLOWING PRECAUTIONS ARE NECESSARY.
2. STORE THEM IN A SEALED POLYETHYLENE BAG. IF PROPERLY SEALED, THERE IS NO NEED FOR DESICCANT.
3. STORE THEM IN A DARK PLACE. DO NOT EXPOSE TO SUNLIGHT OR FLUORESCENT LIGHT, KEEP THE TEMPERATURE BETWEEN 0°C AND 35°C.
4. ENVIRONMENTAL CONDITIONS:
5. DO NOT LEAVE THEM FOR MORE THAN 168HRS. AT 60°C.
6. SHOULD NOT BE LEFT FOR MORE THAN 48HRS. AT -20°C.

SAFETY

1. ITS RECOMMENDED TO CRUSH DAMAGED OR UNNECESSARY LCD INTO PIECES AND WASH THEM OFF WITH SOLVENTS SUCH AS ACETONE AND ETHANOL, WHICH SHOULD LATER BE BURNED.
2. IF ANY LIQUID LEAKS OUT OF DAMAGED GLASS CELL AND COMES IN CONTACT WITH THE HANDS, WASH OFF THOROUGHLY WITH SOAP AND WATER.

UNCONTROLLED DOCUMENT

\*UNLESS OTHERWISE SPECIFIED TOLERANCES PER DECIMAL PRECISION ARE: X=±1 (±0.039), X.X=±0.5 (±0.020), X.XX=±0.25 (±0.010), X.XXX=±0.127 (±0.005). LEAD SIZE=±0.05 (±0.002), LEAD LENGTH=±0.75 (±0.030). MIN.= +DECIMAL PRECISION -0.00 MAX.= +0.00 -DECIMAL PRECISION

REV.	PART NUMBER LCT-H320240M35W	<p align="center"><b>CONFIDENTIAL INFORMATION</b></p> <p>THE INFORMATION CONTAINED IN THIS DOCUMENT IS THE PROPERTY OF LUMEX INC. EXCEPT AS SPECIFICALLY AUTHORIZED IN WRITING BY LUMEX INC., THE HOLDER OF THIS DOCUMENT SHALL KEEP ALL INFORMATION CONTAINED HEREIN CONFIDENTIAL AND SHALL PROTECT SAME IN WHOLE OR IN PART FROM DISCLOSURE AND DISSEMINATION TO ALL THIRD PARTIES.</p> <p align="center"><b>RELIABILITY NOTE</b></p> <p>OUR MANY YEARS OF EXPERIENCE DATA ACCUMULATION INDICATE THAT SOLDER HEAT IS A MAJOR CAUSE OF EARLY AND FUTURE FAILURE. PLEASE PAY ATTENTION TO YOUR SOLDERING PROCESS.</p>	 <p>290 E. HELEN ROAD  PALATINE, IL 60067-6976  PHONE: +1.847.359.2790  US WEB: www.lumex.com  TW WEB: www.lumex.com.tw</p>	DRAWN BY: JN	CHECKED BY:	APPROVED BY:	DATE: 04.27.09
	3.5" ACTIVE MATRIX FULL COLOR TFT PANEL 6:00 VIEW, LED BACKLIGHT, -20°C TO +70°C OPERATING TEMP.						PAGE: 8 OF 9 SCALE: N/A



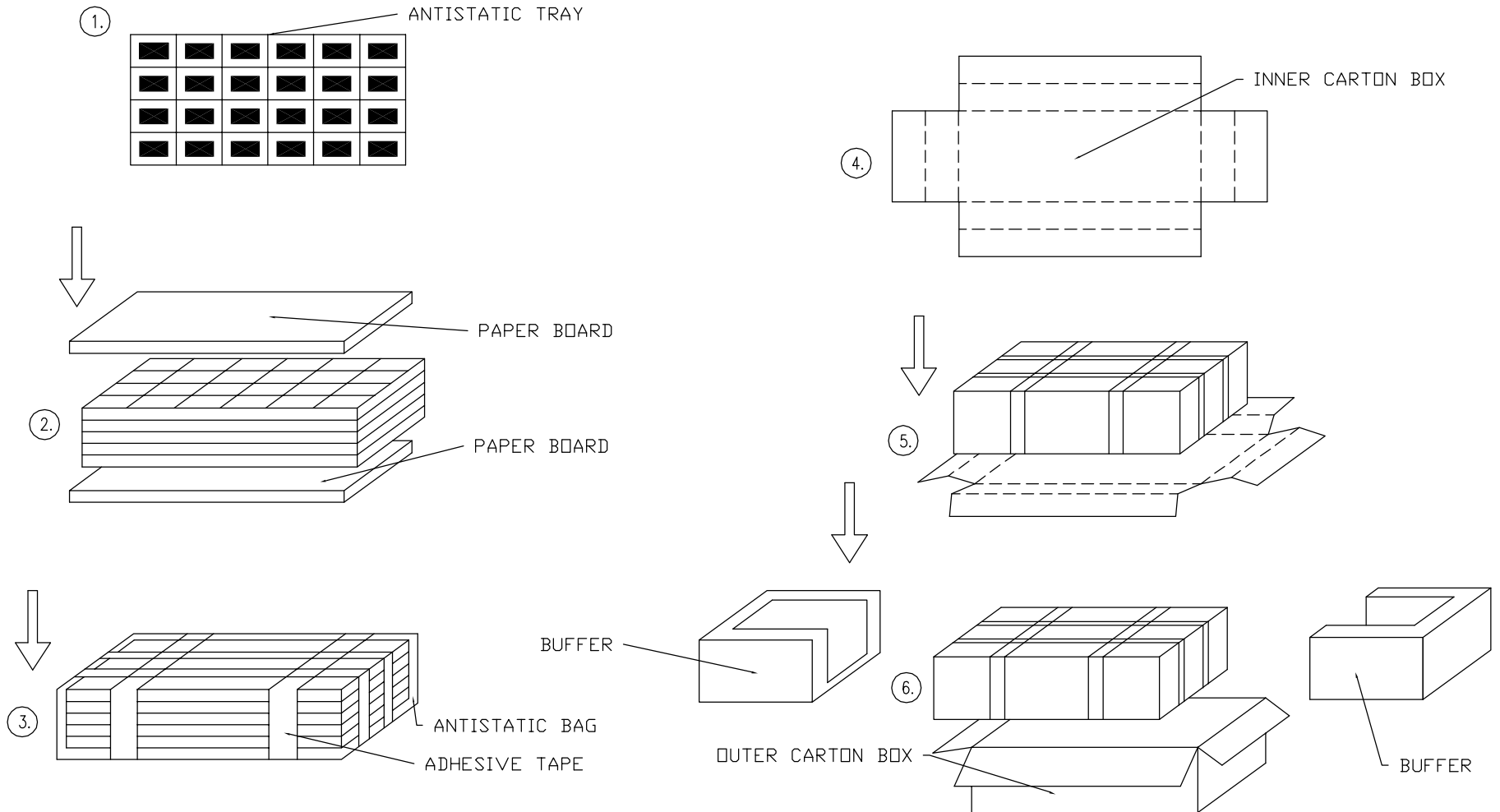

\*UNLESS OTHERWISE SPECIFIED TOLERANCES PER DECIMAL PRECISION ARE: X=±1 (±0.039), X.X=±0.5 (±0.020), X.XX=±0.25 (±0.010), X.XXX=±0.127 (±0.005). LEAD SIZE=±0.05 (±0.002), LEAD LENGTH=±0.75 (±0.030). MIN.= +DECIMAL PRECISION -0.00 MAX.= +0.00 -DECIMAL PRECISION

REV.	PART NUMBER LCT-H320240M35W	<p><b>CONFIDENTIAL INFORMATION</b> THE INFORMATION CONTAINED IN THIS DOCUMENT IS THE PROPERTY OF LUMEX INC. EXCEPT AS SPECIFICALLY AUTHORIZED IN WRITING BY LUMEX INC., THE HOLDER OF THIS DOCUMENT SHALL KEEP ALL INFORMATION CONTAINED HEREIN CONFIDENTIAL AND SHALL PROTECT SAME IN WHOLE OR IN PART FROM DISCLOSURE AND DISSEMINATION TO ALL THIRD PARTIES.</p>	<p><b>LUMEX</b> Creating LED and LCD Solutions Together™</p> <p>290 E. HELEN ROAD PALATINE, IL 60067-6976 PHONE: +1.847.359.2790 US WEB: www.lumex.com TW WEB: www.lumex.com.tw</p>				
3.5" ACTIVE MATRIX FULL COLOR TFT PANEL 6:00 VIEW, LED BACKLIGHT, -20°C TO +70°C OPERATING TEMP.		<p><b>RELIABILITY NOTE</b> OUR MANY YEARS OF EXPERIENCE DATA ACCUMULATION INDICATE THAT SOLDER HEAT IS A MAJOR CAUSE OF EARLY AND FUTURE FAILURE. PLEASE PAY ATTENTION TO YOUR SOLDERING PROCESS.</p>	<table border="1"> <tr> <td data-bbox="1291 1461 1470 1562">DRAWN BY: JN</td> <td data-bbox="1470 1461 1648 1562">CHECKED BY:</td> <td data-bbox="1648 1461 1827 1562">APPROVED BY:</td> <td data-bbox="1827 1461 2051 1562">DATE: 04.27.09 PAGE: 9 OF 9 SCALE: N/A</td> </tr> </table>	DRAWN BY: JN	CHECKED BY:	APPROVED BY:	DATE: 04.27.09 PAGE: 9 OF 9 SCALE: N/A
DRAWN BY: JN	CHECKED BY:	APPROVED BY:	DATE: 04.27.09 PAGE: 9 OF 9 SCALE: N/A				