

Single N-channel MOSFET

ELM13416CA-S

■ General description

ELM13416CA-S uses advanced trench technology to provide excellent $R_{ds(on)}$, low gate charge and operation with gate voltages as low as 1.8V and internal ESD protection is included.

■ Features

- $V_{ds}=20V$
- $I_d=6.5A$ ($V_{gs}=4.5V$)
- $R_{ds(on)} < 22m\Omega$ ($V_{gs}=4.5V$)
- $R_{ds(on)} < 26m\Omega$ ($V_{gs}=2.5V$)
- $R_{ds(on)} < 34m\Omega$ ($V_{gs}=1.8V$)
- ESD protected

■ Maximum absolute ratings

Parameter	Symbol	Limit	Unit	Note	
Drain-source voltage	V_{ds}	20	V		
Gate-source voltage	V_{gs}	± 8	V		
Continuous drain current	I_d	$T_a=25^\circ C$	6.5	A	
		$T_a=70^\circ C$	5.2		
Pulsed drain current	I_{dm}	30	A	3	
Power dissipation	P_d	$T_a=25^\circ C$	1.4	W	2
		$T_a=70^\circ C$	0.9		
Junction and storage temperature range	T_j, T_{stg}	-55 to 150	$^\circ C$		

■ Thermal characteristics

Parameter		Symbol	Typ.	Max.	Unit	Note
Maximum junction-to-ambient	$t \leq 10s$	$R_{\theta ja}$	70	90	$^\circ C/W$	1
Maximum junction-to-ambient	Steady-state		100	125	$^\circ C/W$	1, 4
Maximum junction-to-lead	Steady-state	$R_{\theta jl}$	63	80	$^\circ C/W$	

■ Pin configuration

SOT-23(TOP VIEW)

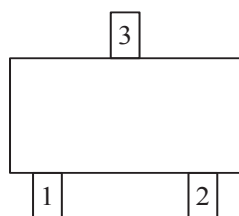

Pin No.	Pin name
1	GATE
2	SOURCE
3	DRAIN

■ Circuit

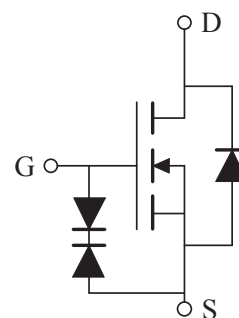

Single N-channel MOSFET

ELM13416CA-S

■Electrical characteristics

Ta=25°C

Parameter	Symbol	Condition	Min.	Typ.	Max.	Unit
STATIC PARAMETERS						
Drain-source breakdown voltage	BVdss	Id=250μA, Vgs=0V	20			V
Zero gate voltage drain current	Idss	Vds=20V, Vgs=0V			1	μA
		Tj=55°C			5	
Gate-body leakage current	Igss	Vds=0V, Vgs=±8V			±10	μA
Gate threshold voltage	Vgs(th)	Vds=Vgs, Id=250μA	0.4	0.7	1.1	V
On state drain current	Id(on)	Vgs=4.5V, Vds=5V	30			A
Static drain-source on-resistance	Rds(on)	Vgs=4.5V, Id=6.5A		16	22	mΩ
		Tj=125°C		22	30	
		Vgs=2.5V, Id=5.5A		18	26	
		Vgs=1.8V, Id=5A		21	34	
Forward transconductance	Gfs	Vds=5V, Id=6.5A		50		S
Diode forward voltage	Vsd	Is=1A, Vgs=0V		0.62	1.00	V
Max. body-diode continuous current	Is				2	A
DYNAMIC PARAMETERS						
Input capacitance	Ciss			1295	1650	pF
Output capacitance	Coss	Vgs=0V, Vds=10V, f=1MHz		160		pF
Reverse transfer capacitance	Crss			87		pF
Gate resistance	Rg	Vgs=0V, Vds=0V, f=1MHz		1.8		kΩ
SWITCHING PARAMETERS						
Total gate charge	Qg			10.0		nC
Gate-source charge	Qgs	Vgs=4.5V, Vds=10V, Id=6.5A		4.2		nC
Gate-drain charge	Qgd			2.6		nC
Turn-on delay time	td(on)			280.00		ns
Turn-on rise time	tr	Vgs=4.5V, Vds=10V		328.00		ns
Turn-off delay time	td(off)	RI=1.54Ω, Rgen=3Ω		3.76		ns
Turn-off fall time	tf			2.24		ns
Body diode reverse recovery time	trr	If=6.5A, dl/dt=100A/μs		31	41	ns
Body diode reverse recovery charge	Qrr	If=6.5A, dl/dt=100A/μs		6.8		nC

NOTE :

1. The value of Rθja is measured with the device mounted on 1in2 FR-4 board of 2oz. Copper, in still air environment with Ta =25°C. The value in any given application depends on the user's specific board design.
2. The power dissipation Pd is based on Tj(Max)=150°C, using 10s junction-to-ambient thermal resistance.
3. Repetitive rating, pulse width limited by junction temperature Tj(Max)=150°C. Ratings are based on low frequency and duty cycles to keep initial Tj=25°C.
4. The Rθja is the sum of the thermal impedance from junction to lead Rθjl and lead to ambient.
5. The static characteristics in Figures 1 to 6 are obtained using <300μs pulses, duty cycle 0.5% max.
6. These curves are based on the junction-to-ambient thermal impedance which is measured with the device mounted on 1in2 FR-4 board with 2oz.Copper, assuming a maximum junction temperature of Tj(Max)=150°C. The SOA curve provides a single pulse rating.

Single N-channel MOSFET

ELM13416CA-S

■ Typical electrical and thermal characteristics

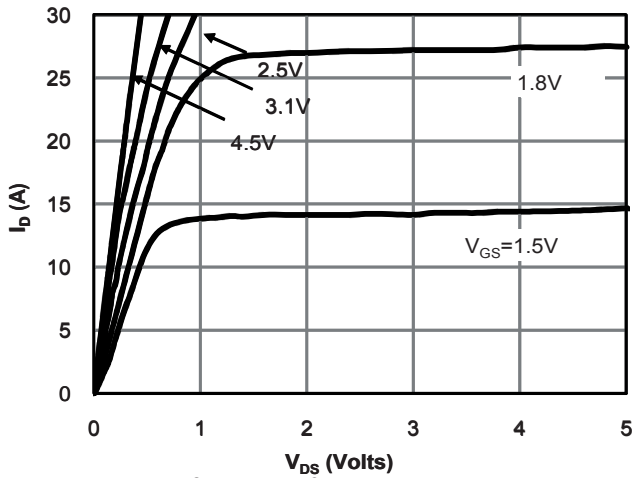

Fig 1: On-Region Characteristics (Note E)

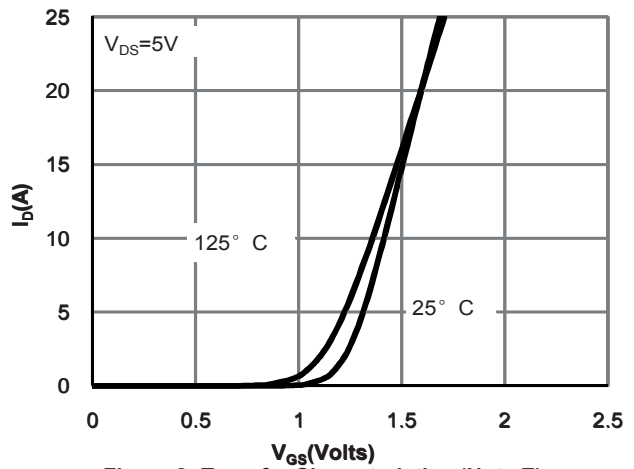

Figure 2: Transfer Characteristics (Note E)

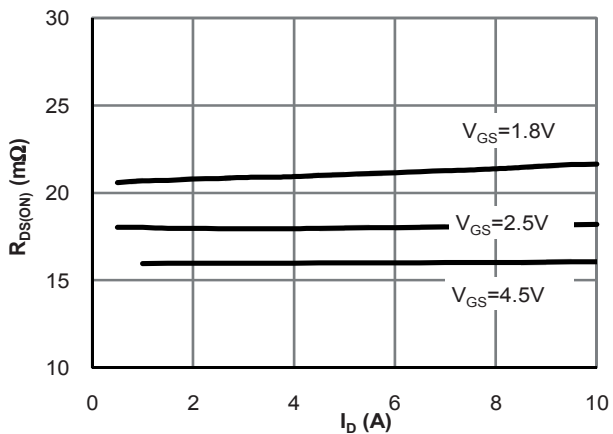

Figure 3: On-Resistance vs. Drain Current and Gate Voltage (Note E)

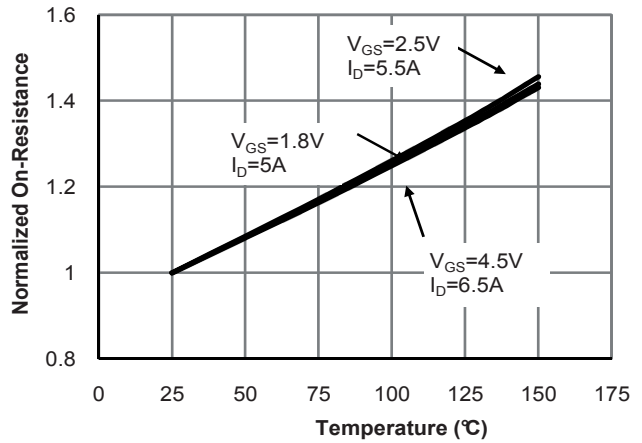

Figure 4: On-Resistance vs. Junction Temperature (Note E)

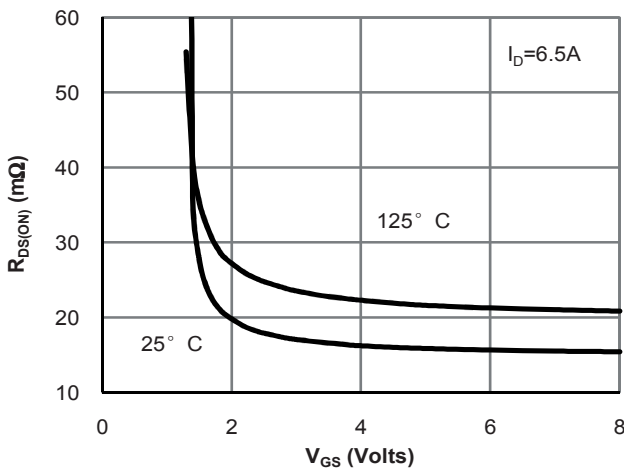

Figure 5: On-Resistance vs. Gate-Source Voltage (Note E)

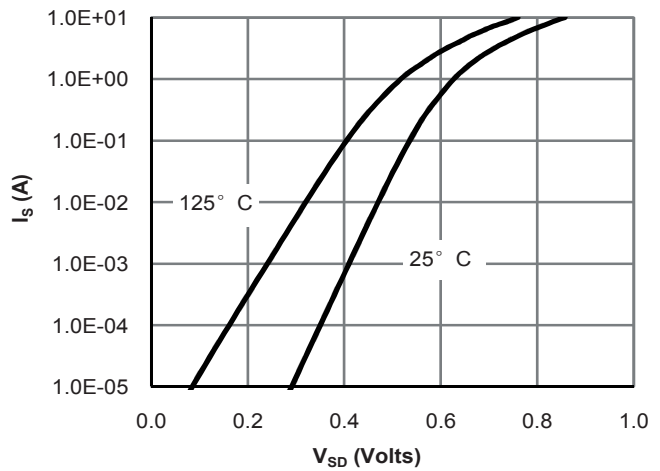

Figure 6: Body-Diode Characteristics (Note E)

Single N-channel MOSFET

ELM13416CA-S

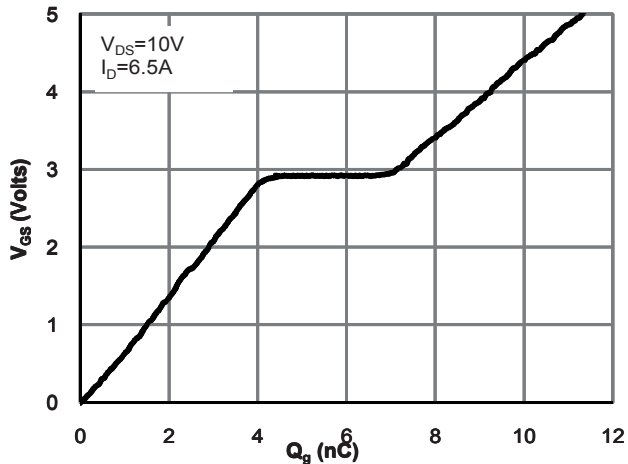

Figure 7: Gate-Charge Characteristics

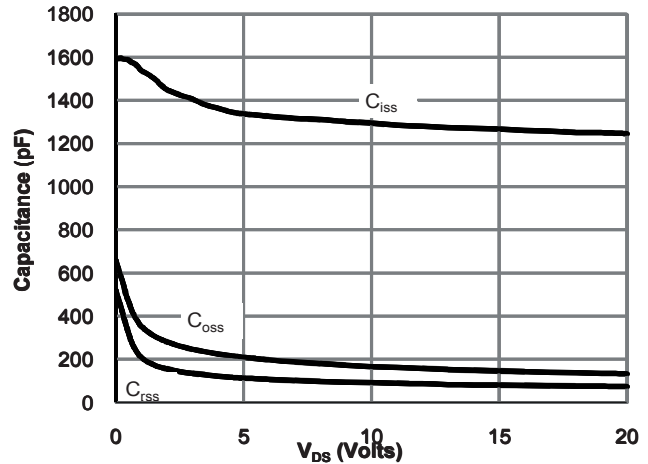

Figure 8: Capacitance Characteristics

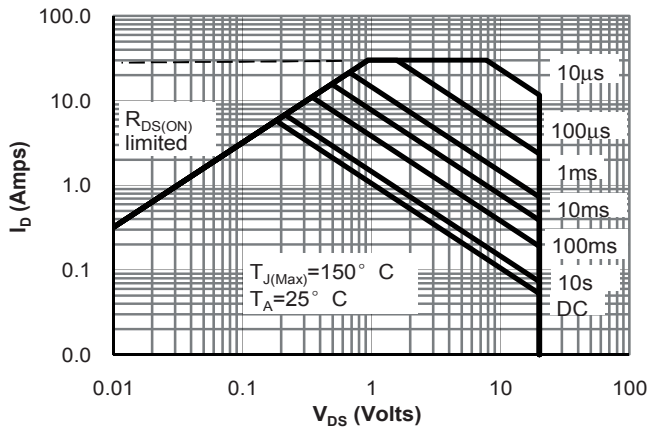

Figure 9: Maximum Forward Biased Safe Operating Area (Note F)

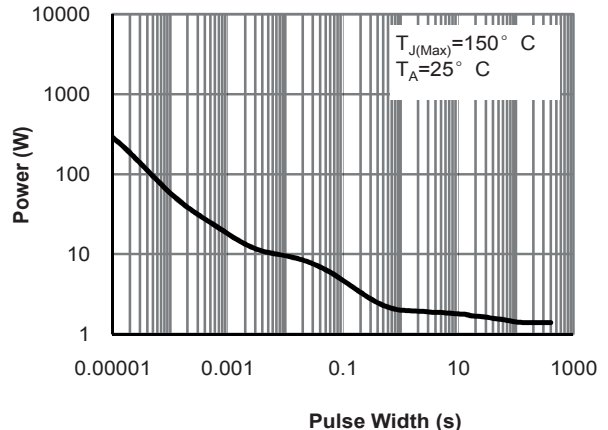

Figure 10: Single Pulse Power Rating Junction-to-Ambient (Note F)

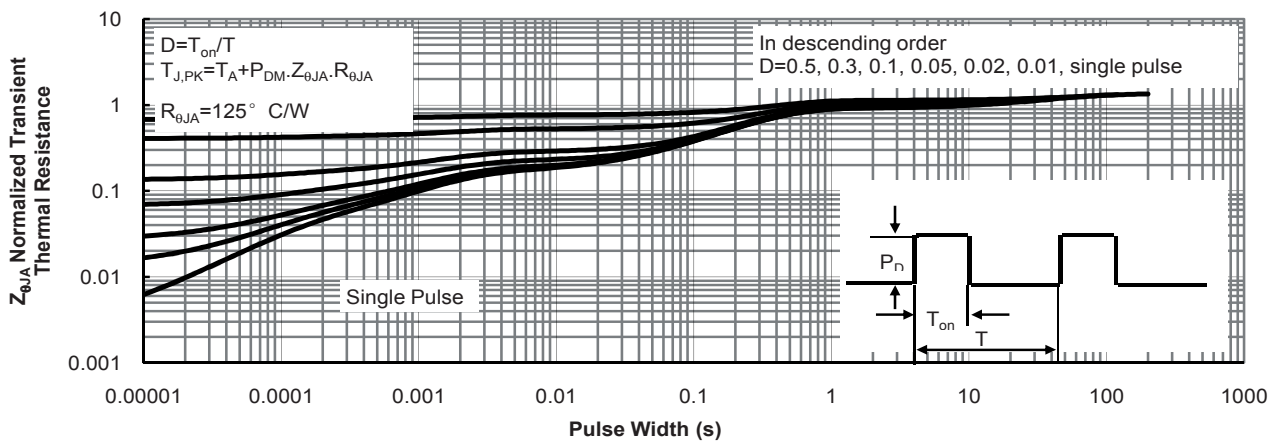

Figure 11: Normalized Maximum Transient Thermal Impedance (Note F)

Single N-channel MOSFET

ELM13416CA-S

■ Test circuit & waveform

Gate Charge Test Circuit & Waveform

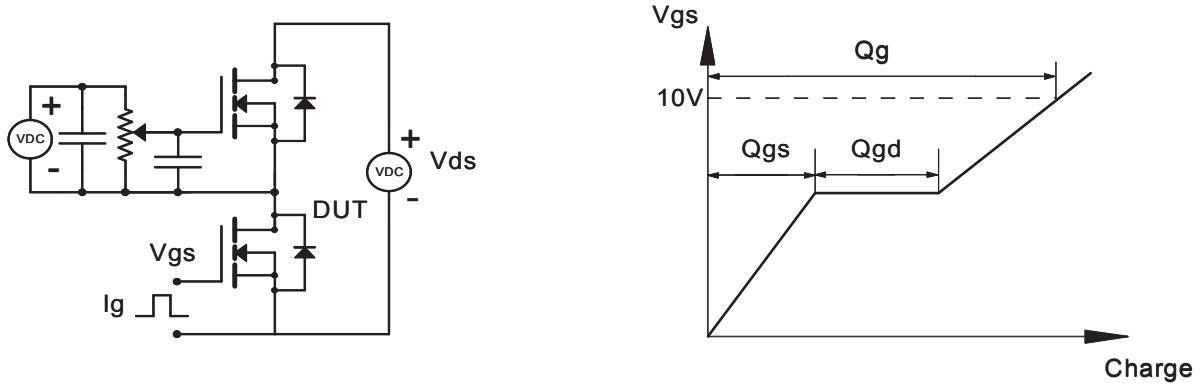

Resistive Switching Test Circuit & Waveforms

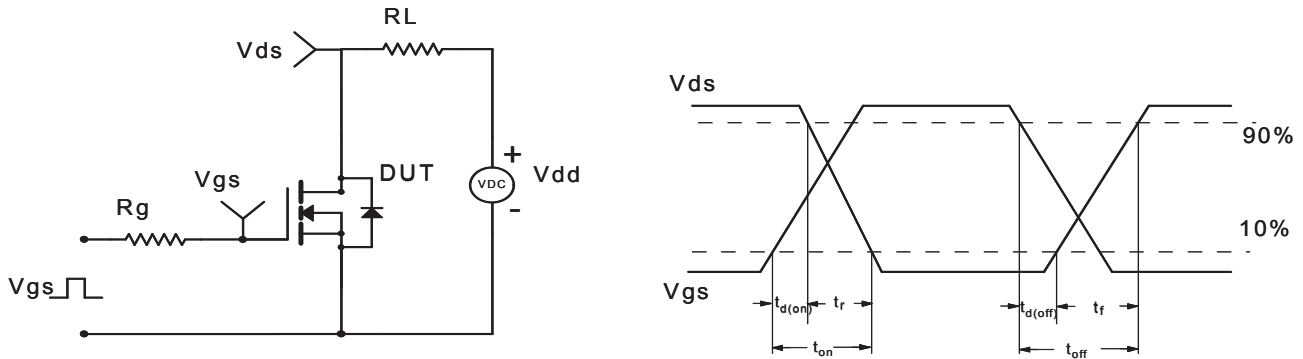

Diode Recovery Test Circuit & Waveforms

