

TFA9882

3.4 W I²S input mono class-D audio amplifier

Rev. 2 — 20 April 2011

Product data sheet

1. General description

The TFA9882 is a mono, filter-free class-D audio amplifier in a 9-bump WLCSP (Wafer Level Chip-Size Package) with a 400 μm pitch.

It receives audio and control settings via an I²S digital interface. The Power-down to Operating mode transition is triggered when a clock signal is detected on the bit clock input (BCK). Two devices can be combined to build a stereo application.

In stereo applications, the left or right I²S audio stream is selected by connecting the word select signal to, respectively, pin WSL or pin WSR. Mono mixing can be achieved by connecting the word select signal to both WSL and WSR. Switching off the word select signal selects Mute mode.

The device features low RF susceptibility because it has a digital input interface that is insensitive to clock jitter. The second order closed loop architecture used in the TFA9882 provides excellent audio performance and high supply voltage ripple rejection.

2. Features and benefits

- Small outline WLCSP9 package: 1.27 × 1.49 × 0.6 mm
- Wide supply voltage range (fully operational from 2.5 V to 5.5 V)
- High efficiency (90 %, 4 Ω /20 μH load) and low power dissipation
- Quiescent power:
 - ◆ 6.5 mW ($V_{\text{DDD}} = 1.8 \text{ V}$, $V_{\text{DDP}} = 3.6 \text{ V}$, 4 Ω /20 μH load, $f_s = 32 \text{ kHz}$)
 - ◆ 7.65 mW ($V_{\text{DDD}} = 1.8 \text{ V}$, $V_{\text{DDP}} = 3.6 \text{ V}$, 4 Ω /20 μH load, $f_s = 48 \text{ kHz}$)
- Output power:
 - ◆ 1.4 W into 4 Ω at 3.6 V supply (THD = 1 %)
 - ◆ 2.7 W into 4 Ω at 5.0 V supply (THD = 1 %)
 - ◆ 3.4 W into 4 Ω at 5.0 V supply (THD = 10 %)
- Output noise voltage: 24 μV (A-weighted)
- Signal-to-noise ratio: 103 dB ($V_{\text{DDP}} = 5 \text{ V}$, A-weighted)
- Fully short-circuit proof across load and to supply lines
- Current limiting to avoid audio holes
- Thermally protected
- Undervoltage and overvoltage protection
- High-pass filter for DC blocking
- Simplified interface for audio and control settings
- Left/right selection and mono mixing
- Three gain settings: -3 dB, 0 dB and +3 dB



- Output slope setting for EMI reduction
- Clip control for smooth clipping
- Mute mode
- Low RF susceptibility
- Insensitive to input clock jitter
- 'Pop noise' free at all mode transitions
- Short power-up time: 4 ms
- Short power-down time: 5 μ s
- 1.8 V/3.3 V tolerant digital inputs
- Only two external components required

3. Applications

- PDAs
- Mobile phones
- Portable gaming devices
- Portable Navigation Devices (PND)
- Notebooks/netbooks
- Portable media players

4. Quick reference data

Table 1. Quick reference data

All parameters are guaranteed for $V_{DDP} = 3.6$ V; $V_{DDD} = 1.8$ V; $R_L = 4 \Omega$ [1]; $L_L = 20 \mu H$ [1]; $f_i = 1$ kHz; $f_s = 48$ kHz; $T_{amb} = 25$ °C; default settings, unless otherwise specified.

Symbol	Parameter	Conditions	Min	Typ	Max	Unit
V_{DDP}	power supply voltage	on pin V_{DDP}	2.5	-	5.5	V
V_{DDD}	digital supply voltage	on pin V_{DDD}	1.65	1.8	1.95	V
I_{DDP}	power supply current	Operating mode with load	-	1.5	1.7	mA
		Mute mode	-	1.1	1.25	mA
		Power-down mode	-	0.1	1	μ A
I_{DDD}	digital supply current	Operating mode	-	1.25	1.4	mA
		Mute mode	-	1.1	1.2	mA
		Power-down mode BCK = WS = DATA = 0 V	-	2.5	10	μ A
$P_{o(RMS)}$	RMS output power	THD + N = 1 %				
		$V_{DDP} = 3.6$ V, $f_i = 100$ Hz	-	1.4	-	W
		$V_{DDP} = 5.0$ V, $f_i = 100$ Hz	-	2.7	-	W
		THD + N = 10 %				
		$V_{DDP} = 3.6$ V, $f_i = 100$ Hz	-	1.75	-	W
	$V_{DDP} = 5.0$ V, $f_i = 100$ Hz	-	3.4	-	W	
η_{po}	output power efficiency	$P_{o(RMS)} = 1.4$ W	-	90	-	%

[1] R_L = load resistance; L_L = load inductance.

5. Ordering information

Table 2. Ordering information

Type number	Package		Version
	Name	Description	
TFA9882UK	WLCSP9	wafer level chip-size package; 9 bumps; body 1.49 × 1.27 mm	TFA9882UK

6. Block diagram

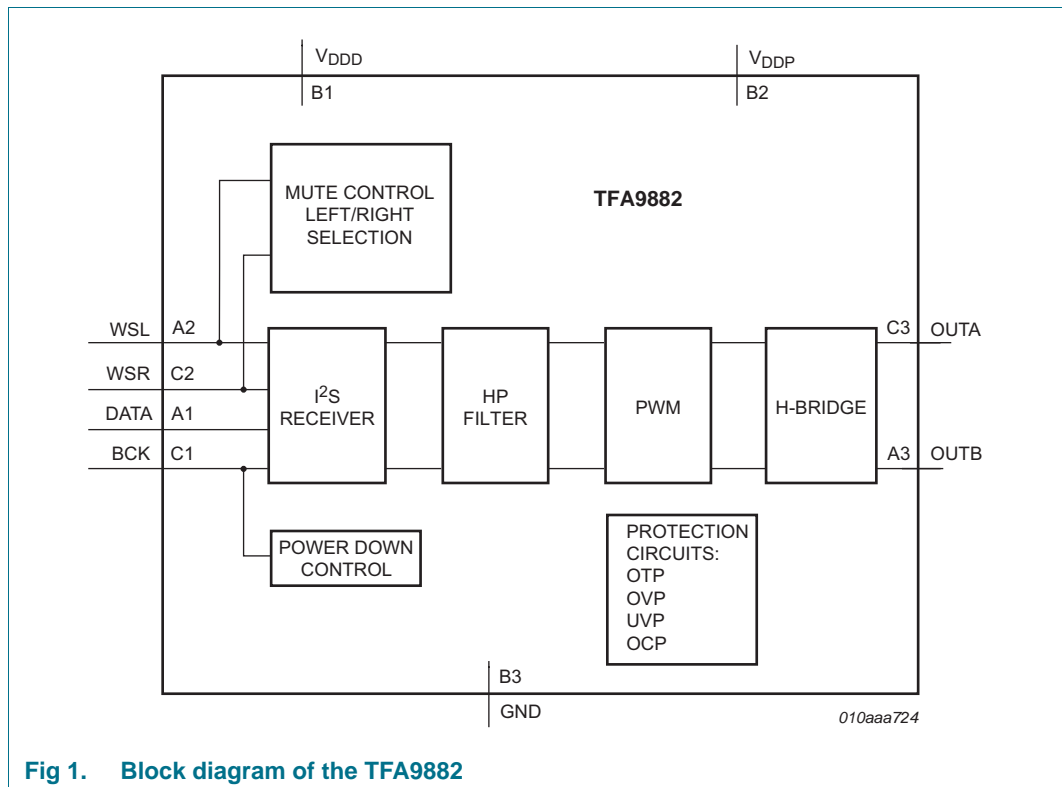

Fig 1. Block diagram of the TFA9882

7. Pinning information

7.1 Pinning

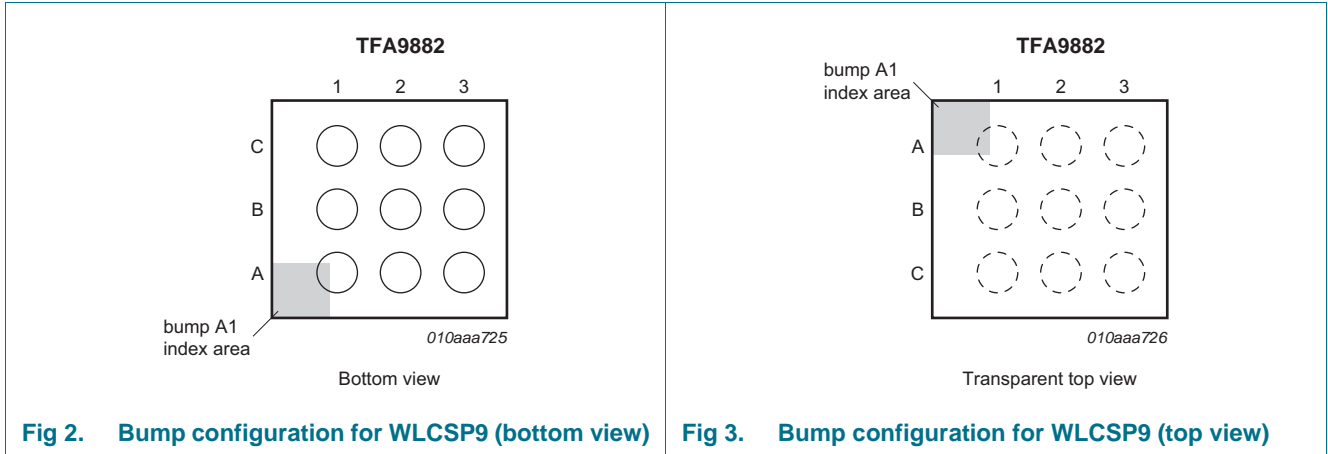

Fig 2. Bump configuration for WLCSP9 (bottom view)

Fig 3. Bump configuration for WLCSP9 (top view)

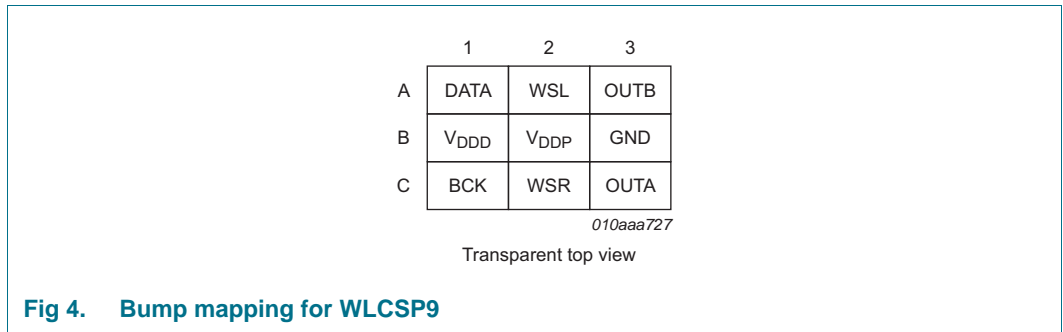

Fig 4. Bump mapping for WLCSP9

7.2 Pin description

Table 3. Pin description

Symbol	Pin	Type	Description
DATA	A1	I	data input
WSL	A2	I	word select input left channel; connect to V _{DDP} or PCB ground if right channel is selected
OUTB	A3	O	inverting output
V _{DDD}	B1	P	digital supply voltage (1.8 V)
V _{DDP}	B2	P	power supply voltage (2.5 V to 5.5 V)
GND	B3	P	ground reference
BCK	C1	I	bit clock input
WSR	C2	I	word select input right channel; connect to V _{DDP} or PCB ground if left channel is selected
OUTA	C3	O	non-inverting output

8. Functional description

The TFA9882 is a high-efficiency mono Bridge Tied Load (BTL) class-D audio amplifier with a digital stereo I²S input interface. A High-Pass (HP) filter removes the DC components from the incoming I²S stream. This stream is subsequently converted into two Pulse Width Modulated (PWM) signals. A 3-level PWM scheme supports filterless speaker drive.

8.1 Mode selection and interfacing

The TFA9882 supports four operating modes:

- **Power-down mode**, with low supply current
- **Mute mode**, in which the output stages are floating so that the audio input signal is suppressed
- **Operating mode**, in which the amplifier is fully operational, delivering an output signal
- **Fault mode**

The TFA9882 switches to Fault mode automatically when a protection mechanism is activated (see [Section 8.8](#)). The defined patterns required on the BCK, WSL and WSR inputs to select the other three modes are given in [Table 4](#).

Power-down mode is selected when there is no bit clock signal on the BCK input. Applying the bit clock signal will cause the TFA9882 to switch from Power-down mode to Operating mode (provided the word select signal is switched on).

Mute mode is activated when the word select signal is switched off.

The left or right channel is selected by applying the word select signal to, respectively, the WSL or the WSR terminal. The word select terminal not connected should be connected to V_{DDP} or to PCB ground. This simplifies the connection to the V_{DDP} terminal in the WLCSP9 package.

When the word select signal is connected to both terminals, the TFA9882 amplifies the sum of both channels divided by two.

Table 4. Mode selection

Mode	Channel	Frequency on BCK	Frequency on WSL	Frequency on WSR	OUTA, OUTB
Power-down		0 Hz	don't care	don't care	floating
Mute		2.048 MHz to 3.072 MHz	0 Hz	0 Hz	floating
Operating	left	2.048 MHz to 3.072 MHz	32 kHz to 48 kHz	0 Hz	switching
	right	2.048 MHz to 3.072 MHz	0 Hz	32 kHz to 48 kHz	switching
	(left + right) / 2	2.048 MHz to 3.072 MHz	32 kHz to 48 kHz	32 kHz to 48 kHz	switching

8.2 I²S format

The TFA9882 supports the Philips I²S standard with a BCK frequency 64 times greater than the sampling rate (64f_s). The bit length can be from 8 to 32 bits. Supported I²S sample rates are listed in [Table 5](#) while [Figure 5](#) illustrates the I²S data transfer format.

Table 5. Supported I²S sample rates

f _s (kHz)	WS (kHz)	BCK, 64f _s (MHz)
32	32	2.048
44.1	44.1	2.8224
48	48	3.072

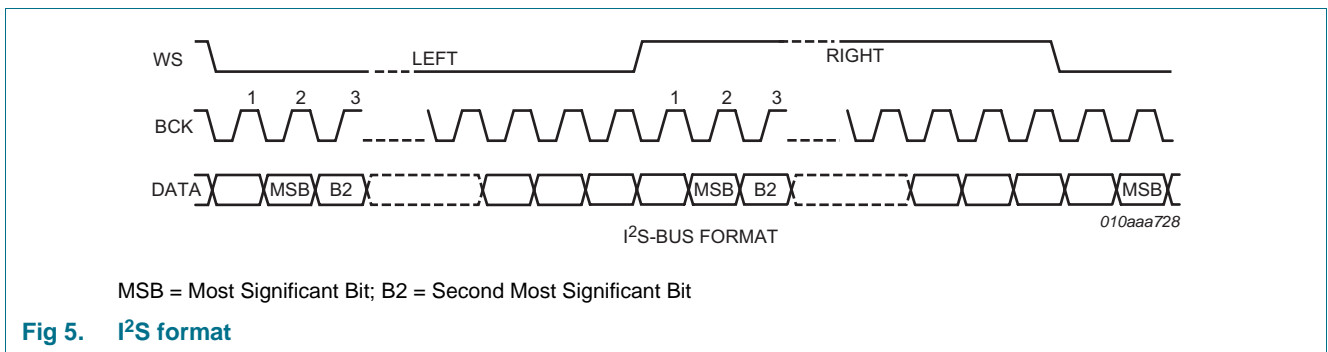

8.3 Power-up/power-down sequence

The TFA9882 power-up/power-down sequence is shown in Figure 6. External power supplies V_{DDP} and V_{DDD} should be within their operating limits before the TFA9882 switches to Operating mode. The TFA9882 should be switched to Power-down mode before the power supplies are disconnected or turned off.

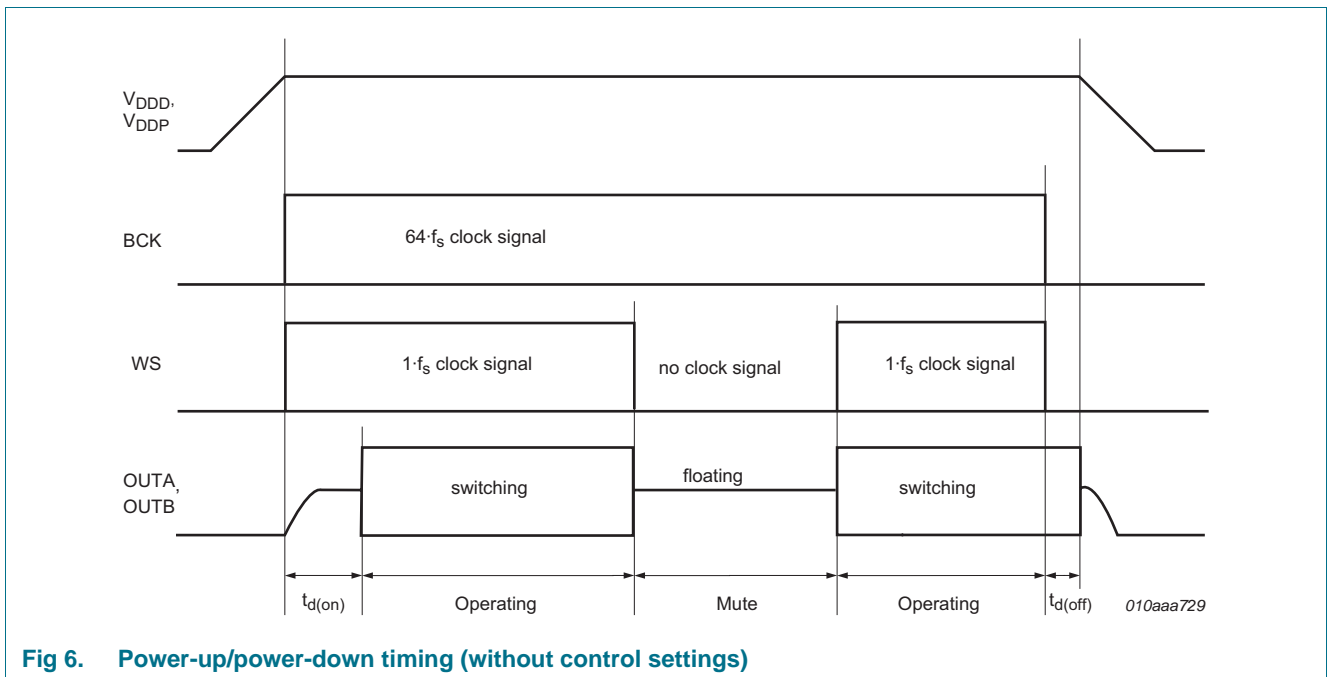

Table 6. Power-up/power-down timing

All parameters are guaranteed for $V_{DDP} = 3.6\text{ V}$; $V_{DDN} = 1.8\text{ V}$; $R_L = 4\ \Omega$ [1]; $L_L = 20\ \mu\text{H}$ [1]; $f_i = 1\text{ kHz}$; $f_s = 48\text{ kHz}$; $T_{amb} = 25\text{ }^\circ\text{C}$; default settings, unless otherwise specified.

Symbol	Parameter	Conditions	Min	Typ	Max	Unit
$t_{d(on)}$	turn-on delay time		[2]	-	4	ms
$t_{d(off)}$	turn-off delay time		[2]	-	5	μs

[1] R_L = load resistance; L_L = load inductance.

[2] Inversely proportional to f_s .

8.4 Control settings

If the device can operate effectively with the default settings, the control settings don't need to be changed.

8.4.1 Control setting pattern recognition

The TFA9882 can detect control settings via the I²S input. Control settings are selected by transmitting control patterns on the DATA input during the power-up sequence (the first 12288 bit clock cycles). The word select signal (WS) must be switched off during this interval. Figure 7 illustrates the control setting sequence. After receiving 128 consecutive control setting bytes, the TFA9882 activates the appropriate control setting (see the third column of Table 7). Control settings remain unchanged in all modes unless control pattern 0xAA is received or the V_{DD} supply voltage is removed.

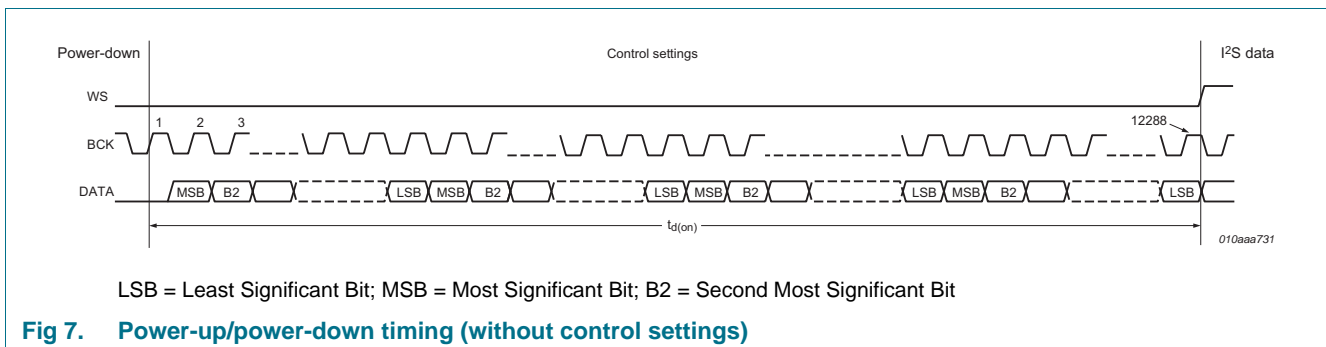

Fig 7. Power-up/power-down timing (without control settings)

Table 7. Control settings

Byte	Related bytes[1]	Control settings
0xD2	0x69/B4/5A/2D/96/4B/A5	clip control on; see Section 8.4.2
0xD4	0x6A/35/9A/4D/A6/53/A9	gain = -3 dB ($V_{DDP} = 2.5\text{ V}$); see Section 8.4.3
0xD8	0x6C/36/1B/8D/C6/63/B1	gain = +3 dB ($V_{DDP} = 5.0\text{ V}$); see Section 8.4.3
0xE1	0xF0/78/3C/1E/0F/87/C3	slope low (EMC); see Section 8.4.4
0xE2	0x71/B8/5C/2E/17/8B/C5	Dynamic Power Stage Activation (DPSA) off; see Section 8.4.5
0xAA	0x55	Default; no mute, reset settings to default

[1] The related bytes are the bytes from the first column phase shifted by 1, 2, 3, 4, 5, 6 and 7 bits.

8.4.2 Clip control

TFA9882 clip control is off by default. Clip control can be turned on via control setting 0xD2 (see [Section 8.4.1](#)). The TFA9882 clips smoothly with clip control on. Output power is at maximum with clip control off.

8.4.3 Gain selection

Signal conversion from digital audio to PWM modulated audio out is independent of supply voltages V_{DDP} and V_{DDD} . At the default gain setting (0 dB), the audio output signal level is just below the clipping point at a supply voltage of 3.6 V at -6 dBFS (peak) input. The TFA9882 supports two further gain settings to support full output power at $V_{DDP} = 2.5$ V and $V_{DDP} = 5.0$ V. The gain settings can be selected via control settings 0xD4 and 0xD8 (see [Section 8.4.1](#)).

[Table 8](#) details the corresponding peak output voltage level at -6 dBFS for the three gain settings.

Table 8. Output voltage

All parameters are guaranteed for $V_{DDP} = 3.6$ V; $V_{DDD} = 1.8$ V; $R_L = 4 \Omega$ [1], $L_L = 20 \mu H$ [1], $f_i = 1$ kHz, $f_s = 48$ kHz, $T_{amb} = 25$ °C, default settings; unless otherwise specified.

Symbol	Parameter	Conditions	Min	Typ	Max	Unit	
V_{oM}	peak output voltage	at -6 dBFS (peak) digital input					
		gain = -3 dB, $V_{DDP} = 2.5$ V, $R_L = 4 \Omega$	[1]	-	2.4	-	V
		gain = 0 dB, $V_{DDP} = 3.6$ V, $R_L = 4 \Omega$; default	[1]	-	3.4	-	V
		gain = $+3$ dB, $V_{DDP} = 5.0$ V, $R_L = 8 \Omega$	[1]	-	4.7	-	V

[1] R_L = load resistance; L_L = load inductance.

8.4.4 PWM slope selection

The rise and fall times of the PWM output edges can be set to one of two values, as detailed in [Table 9](#). The default setting is 'slope normal' (10 ns with $V_{DDP} = 3.6$ V). 'Slope low' is selected via control setting 0xE1 (see [Section 8.4.1](#)). This function is implemented to reduce ElectroMagnetic Interference (EMI).

Table 9. Slope rise and fall times

Setting	Rise and fall times of the PWM output edges
slope low	40 ns with $V_{DDP} = 3.6$ V
slope normal; default setting	10 ns with $V_{DDP} = 3.6$ V

8.4.5 Dynamic Power Stage Activation (DPSA)

The TFA9882 uses DPSA to regulate current consumption in line with the level of the incoming audio stream. This function switches off power stage sections that are not needed, reducing current consumption.

Each of the TFA9882 H-bridge power stages is divided into eight sections. The number of power stage sections activated depends on the level of the incoming audio stream. The thresholds used by the DPSA to determine how many stages are switched on are given in [Table 10](#). The DPSA signal is used as a reference signal for switching power stage sections on and off. The DPSA signal will rise in tandem with the rectified audio input signal. When the rectified audio input signal falls, the DPSA decreases with a negative exponential function, as illustrated in [Figure 8](#).

The DPSSA function can be switched off via control setting 0xE2 (see [Section 8.4.1](#)). When DPSSA is off, all power stage sections are activated in Operating mode.

Table 10. DPSSA input levels

Setting	Number of power stage sections active
$\leq 0.035 \times \text{full scale (-29 dBFS)}$	1
$> 0.035 \times \text{full scale (-29 dBFS)}$	2
$> 0.07 \times \text{full scale (-23 dBFS)}$	4
$> 0.105 \times \text{full scale (-19.5 dBFS)}$	8

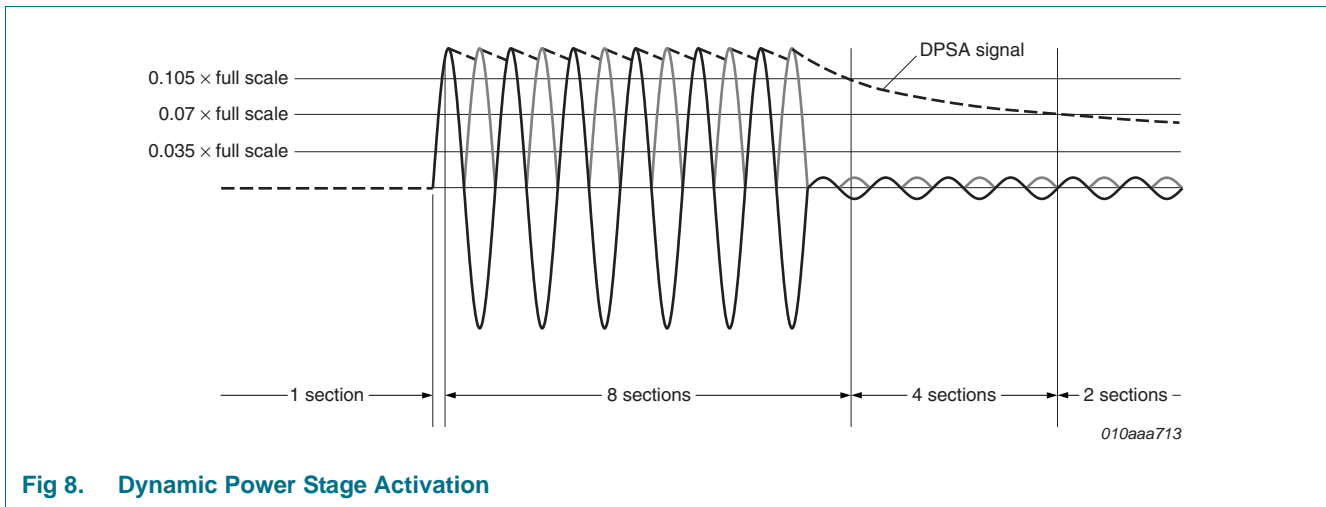

Fig 8. Dynamic Power Stage Activation

8.5 High-pass filter

The high-pass filter blocks the DC components in the incoming audio stream. The cut-off frequency, $f_{\text{high}(-3\text{dB})}$, is determined by the sampling frequency, f_s , and is defined in [Equation 1](#):

$$f_{\text{high}(-3\text{dB})} = \frac{-f_s \cdot \ln(4095/4096)}{2 \cdot \pi} \tag{1}$$

$f_{\text{high}(-3\text{dB})}$ is about 1.9 Hz at a sampling frequency of 48 kHz. The high-pass filter is always enabled.

8.6 PWM frequency

The TFA9882 translates the I2S input stream into an amplified 3-level PWM output signal. The PWM switching frequency is linearly proportional to the sampling frequency, and is defined in [Equation 2](#).

$$f_{\text{sw}(PWM)} = 8 \cdot f_s \tag{2}$$

The PWM switching frequency equals 384 kHz when the sampling frequency is 48 kHz.

8.7 Bandwidth

The TFA9882 output spectrum has a sigma-delta converter characteristic. [Figure 9](#) illustrates the output power spectrum of the TFA9882 when it is receiving an I²S input stream without audio content. The quantization noise is shaped above the band of interest. The band of interest (bandwidth) is determined by the high corner frequency where the noise is increasing. The bandwidth in [Figure 9](#) scales with the sampling frequency and is defined in [Equation 3](#):

$$BW = 0.4535 \cdot f_s \tag{3}$$

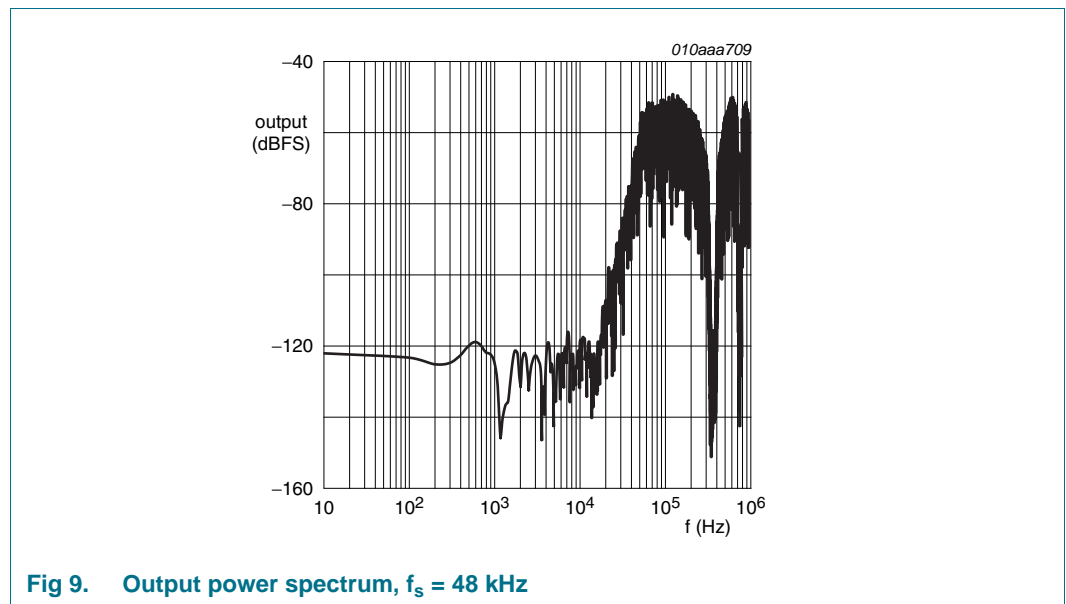

Fig 9. Output power spectrum, $f_s = 48$ kHz

8.8 Protection mechanisms

The following protection circuits are included in the TFA9882:

- OverTemperature Protection (OTP)
- OverVoltage Protection (OVP)
- UnderVoltage Protection (UVP)
- OverCurrent Protection (OCP)

The reaction of the device to fault conditions differs depending on the protection circuit involved.

8.8.1 OverTemperature Protection (OTP)

OTP prevents heat damage to the TFA9882. It is triggered when the junction temperature exceeds $T_{act(th_prot)}$. When this happens, the output stages are set floating. OTP is cleared automatically via an internal timer (200 ms), after which the output stages will start to operate normally again.

8.8.2 Supply voltage protection mechanisms (UVP and OVP)

UVP is activated, setting the outputs floating, if the supply voltage drops below the undervoltage protection threshold, $V_{P(UVP)}$. This transition will be silent, without pop noise. When the supply voltage rises above $V_{P(UVP)}$ again, the system will be restarted after 200 ms.

OVP is activated, setting the power stages floating, if the supply voltage rises above the overvoltage protection threshold, $V_{P(OVP)}$. The power stages are re-enabled as soon as the supply voltage drops below $V_{P(OVP)}$ again. The system will be restarted after 200 ms.

8.8.3 OverCurrent Protection (OCP)

OCP will detect a short circuit across the load or between one of the amplifier outputs and one of the supply lines. If the output current exceeds the overcurrent protection threshold ($I_{O(OCP)}$), it will be limited to $I_{O(OCP)}$ while the amplifier outputs are switching (the amplifier is not powered down completely). This is called current limiting. The amplifier can distinguish between an impedance drop at the loudspeaker and a low-ohmic short circuit across the load or to one of the supply lines. The impedance threshold depends on which supply voltage is being used:

- In the event of a short circuit across the load or a short to one of the supply lines, the audio amplifier is switched off completely. It will try to restart again after approximately 200 ms. If the short-circuit condition is still present after this time, this cycle will be repeated. Average dissipation will be low because of the short duty cycle.
- In the event of an impedance drop (e.g. due to dynamic behavior of the loudspeaker), the same protection mechanism will be activated. The maximum output current is again limited to $I_{O(OCP)}$, but the amplifier will not switch off completely (thus preventing audio holes from occurring). This will result in a clipped output signal without artifacts.

9. Internal circuitry

Table 11. Internal circuitry

Pin	Symbol	Equivalent circuit
A1 C1	DATA BCK	<p>010aaa714</p>
B1 B2	V _{DDD} V _{DDP}	<p>010aaa715</p>
A2 C2	WSL WSR	<p>010aaa716</p>
A3 C3	OUTB OUTA	<p>010aaa717</p>

10. Limiting values

Table 12. Limiting values

In accordance with the Absolute Maximum Rating System (IEC 60134).

Symbol	Parameter	Conditions	Min	Max	Unit
V _{DDP}	power supply voltage	on pin V _{DDP}	-0.3	+5.5	V
V _{DDD}	digital supply voltage	on pin V _{DDD}	-0.3	+1.95	V
T _j	junction temperature		-	+150	°C
T _{stg}	storage temperature		-55	+150	°C
T _{amb}	ambient temperature		-40	+85	°C
V _x	voltage on pin x	pins BCK and DATA	-0.3	+3.6	V
		pins OUTA and OUTB	-0.6	V _{DDP} + 0.6	V
		pins WSL and WSR	-0.6	V _{DDP}	V

Table 12. Limiting values ...continued

In accordance with the Absolute Maximum Rating System (IEC 60134).

Symbol	Parameter	Conditions	Min	Max	Unit
V _{ESD}	electrostatic discharge voltage	according to the Human Body Model (HBM) [1]			
		pins OUTA and OUTB	-8	+8	kV
		any other pin	-2	+2	kV
		according to the Charge Device Model (CDM) [1]	-500	+500	V
		according to the Machine Model (MM) [1]	-200	+200	V

[1] Measurements taken on the TFA9882 in a HVSON10 package (engineering samples) due to handling restrictions with WLCSP9.

11. Thermal characteristics

Table 13. Thermal characteristics

Symbol	Parameter	Conditions	Typ	Unit
R _{th(j-a)}	thermal resistance from junction to ambient	in free air; natural convection		
		JEDEC test board [1]	128	K/W
		2-layer application board	97	K/W
Ψ _{j-top}	thermal characterization parameter from junction to top of package		[2] 12	K/W

[1] Measured on a JEDEC high K-factor test board (standard EIA/JESD 51-7).

[2] Value depends on where measurement is taken on package.

12. Characteristics

12.1 DC characteristics

Table 14. DC characteristicsAll parameters are guaranteed for V_{DDP} = 3.6 V; V_{DDD} = 1.8 V; R_L = 4 Ω [\[1\]](#); L_L = 20 μH [\[1\]](#); f_i = 1 kHz; f_s = 48 kHz; T_{amb} = 25 °C, default slope and gain settings; unless otherwise specified.

Symbol	Parameter	Conditions	Min	Typ	Max	Unit
V _{DDP}	power supply voltage	on pin V _{DDP}	2.5	-	5.5	V
V _{DDD}	digital supply voltage	on pin V _{DDD}	1.65	1.8	1.95	V
I _{DDP}	power supply current	Operating mode with load				
		f _s = 48 kHz	-	1.5	1.7	mA
		f _s = 32 kHz	-	1.38	-	mA
		Mute mode		1.1	1.25	mA
		Power-down mode	-	0.1	1	μA

Table 14. DC characteristics ...continued

All parameters are guaranteed for $V_{DDP} = 3.6\text{ V}$; $V_{DDD} = 1.8\text{ V}$; $R_L = 4\ \Omega$ [1]; $L_L = 20\ \mu\text{H}$ [1]; $f_i = 1\text{ kHz}$; $f_s = 48\text{ kHz}$; $T_{amb} = 25\text{ }^\circ\text{C}$, default slope and gain settings; unless otherwise specified.

Symbol	Parameter	Conditions	Min	Typ	Max	Unit
I_{DD}	digital supply current	Operating mode				
		$f_s = 48\text{ kHz}$	-	1.25	1.4	mA
		$f_s = 32\text{ kHz}$	-	0.85	-	mA
		Mute mode				
		$f_s = 48\text{ kHz}$	-	1.1	1.2	mA
		$f_s = 32\text{ kHz}$	-	0.8	-	mA
		Power-down mode BCK = WS = DATA = 0 V	-	2.5	10	μA
Series resistance output power switches						
R_{DSon}	drain-source on-state resistance		-	125	150	m Ω
Amplifier output pins; pins OUTA and OUTB						
$ V_{O(\text{offset})} $	output offset voltage		-	-	3	mV
BCK, DATA, WSL and WSR						
V_{IH}	HIGH-level input voltage		$0.7V_{DDD}$	-	3.6	V
V_{IL}	LOW-level input voltage		-	-	$0.3V_{DDD}$	V
C_i	input capacitance		-	-	3	pF
Protection						
$T_{act(th_prot)}$	thermal protection activation temperature		130	-	150	$^\circ\text{C}$
$V_{P(ovp)}$	overvoltage protection supply voltage		5.5	-	6.0	V
$V_{P(uvp)}$	undervoltage protection supply voltage		2.3	-	2.5	V
$I_{O(ocp)}$	overcurrent protection output current		1.45	-	-	A

[1] R_L = load resistance; L_L = load inductance.

12.2 AC characteristics

Table 15. AC characteristics

All parameters are guaranteed for $V_{DDP} = 3.6\text{ V}$; $V_{DD} = 1.8\text{ V}$; $R_L = 4\ \Omega$ ^[1]; $L_L = 20\ \mu\text{H}$ ^[1]; $f_i = 1\text{ kHz}$; $f_s = 48\text{ kHz}$; $T_{amb} = 25\text{ }^\circ\text{C}$, default slope and gain settings; unless otherwise specified.

Symbol	Parameter	Conditions	Min	Typ	Max	Unit	
Output power							
$P_{o(RMS)}$	RMS output power	THD + N = 1 %					
		$V_{DDP} = 3.6\text{ V}$, $f_i = 100\text{ Hz}$	-	1.4	-	W	
		$V_{DDP} = 5.0\text{ V}$, $f_i = 100\text{ Hz}$	-	2.7	-	W	
		THD + N = 1 %; $R_L = 8\ \Omega$; $L_L = 44\ \mu\text{H}$					
		$V_{DDP} = 3.6\text{ V}$, $f_i = 100\text{ Hz}$	-	0.75	-	W	
		$V_{DDP} = 5.0\text{ V}$, $f_i = 100\text{ Hz}$	-	1.45	-	W	
		THD + N = 10 %					
		$V_{DDP} = 3.6\text{ V}$, $f_i = 100\text{ Hz}$	-	1.75	-	W	
		$V_{DDP} = 5.0\text{ V}$, $f_i = 100\text{ Hz}$	-	3.4	-	W	
$P_{o(RMS)}$	RMS output power	THD + N = 10 %; $R_L = 8\ \Omega$; $L_L = 44\ \mu\text{H}$					
		$V_{DDP} = 3.6\text{ V}$, $f_i = 100\text{ Hz}$	-	0.95	-	W	
		$V_{DDP} = 5.0\text{ V}$, $f_i = 100\text{ Hz}$	-	1.85	-	W	
Performance							
η_{po}	output power efficiency	$P_{o(RMS)} = 1.4\text{ W}$	-	90	-	%	
THD+N	total harmonic distortion-plus-noise	$P_{o(RMS)} = 100\text{ mW}$	-	0.02	0.1	%	
$V_{n(o)}$	output noise voltage	A-weighted	-	24	-	μV	
S/N	signal-to-noise ratio	$V_{DDP} = 5\text{ V}$; $V_o = 3.4\text{ V (RMS)}$; A-weighted	-	103	-	dB	
PSRR	power supply rejection ratio	$V_{ripple} = 200\text{ mV}$; $f_{ripple} = 217\text{ Hz}$	-	85	-	dB	
V_{oM}	peak output voltage	at -6 dBFS (peak) digital input:					
		gain = -3 dB; $V_{DDP} = 2.5\text{ V}$	-	2.3	-	V	
		gain = 0 dB; $V_{DDP} = 3.6\text{ V}$	3.1	3.3	3.5	V	
		gain = +3 dB; $V_{DDP} = 5.0\text{ V}$; $R_L = 8\ \Omega$	-	4.7	-	V	
Power-up, power-down and propagation times							
$t_{d(on)}$	turn-on delay time		[2]	-	4	ms	
$t_{d(off)}$	turn-off delay time		[2]	-	5	μs	
t_{pD}	propagation delay		[2]	-	600	μs	

[1] R_L = load resistance; L_L = load inductance.

[2] Inversely proportional to f_s .

12.3 I²S timing characteristics

Table 16. I²S timing characteristics

All parameters are guaranteed for $V_{DDP} = 3.6\text{ V}$; $V_{DDD} = 1.8\text{ V}$; $R_L = 4\ \Omega$ ^[1]; $L_L = 20\ \mu\text{H}$ ^[1]; $f_i = 1\text{ kHz}$; $f_s = 48\text{ kHz}$; $T_{amb} = 25\text{ }^\circ\text{C}$, default slope and gain settings; unless otherwise specified.

Symbol	Parameter	Conditions	Min	Typ	Max	Unit
f_s	sampling frequency	on pins WSL or WSR	32	-	48	kHz
f_{clk}	clock frequency	on pin BCK	-	$64f_s$	-	Hz
t_{su}	set-up time	WS edge to BCK HIGH	10	-	-	ns
		DATA edge to BCK HIGH	10	-	-	ns
t_h	hold time	BCK HIGH to WS edge	10	-	-	ns
		BCK HIGH to DATA edge	10	-	-	ns

[1] R_L = load resistance; L_L = load inductance.

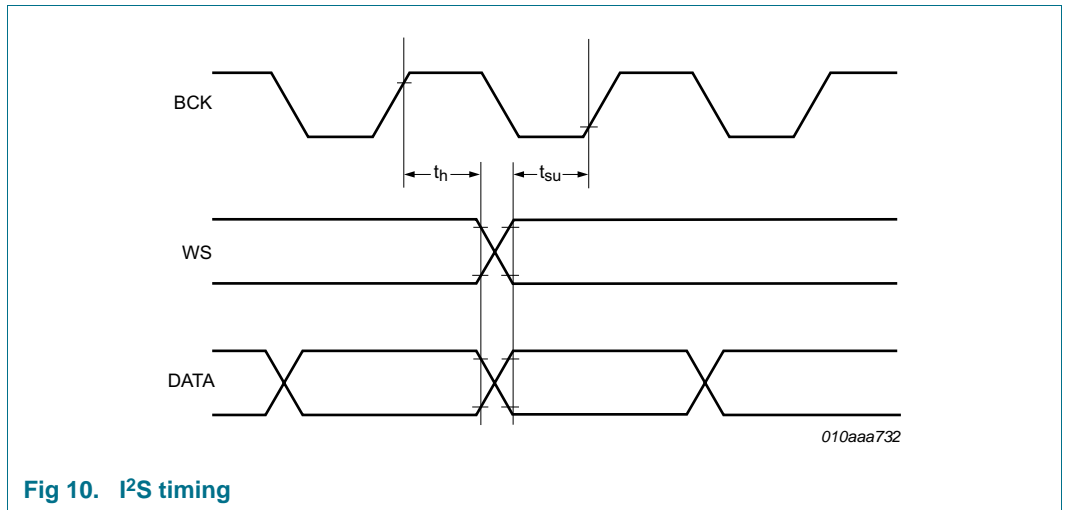

Fig 10. I²S timing

13. Application information

13.1 ElectroMagnetic Compatibility (EMC)

EMC standards define to what degree a (sub)system is susceptible to externally imposed electromagnetic influences and to what degree a (sub)system is responsible for emitting electromagnetic signals, when in Standby mode or Operating mode.

EMC immunity and emission values are normally measured over a frequency range from 180 kHz up to 3 GHz.

13.1.1 Immunity

A major reason why amplifier devices pick up high frequency signals, and (after detection) manifest these in the device's audio band, is the presence of analog circuits inside the device or in the (sub)system.

The TFA9882 has digital inputs and digital outputs. Comparative tests on a TFA9882-based (sub)system show that the impact of externally imposed electromagnetic signals on the device is negligible in both Standby and Operating modes.

13.1.2 Emissions

Since the TFA9882 is a class-D amplifier with digitally switched outputs in a BTL configuration, it can potentially generate emissions due to the steep edges on the amplifier outputs. External components can be used to suppress these emissions. However, the TFA9882 features built-in slope control to suppress such emissions by reducing the slew rate of the BTL output signals. By reducing the slew rate, the emissions are reduced by some 10 dB when compared with full-speed operation.

13.2 Supply decoupling and filtering

A ceramic decoupling capacitor of between 4.7 μF and 10 μF should be placed close to the TFA9882 for decoupling the V_{DDP} supply. This minimizes the size of the high-frequency current loop, thereby optimizing EMC performance.

13.3 Typical application diagram (simplified)

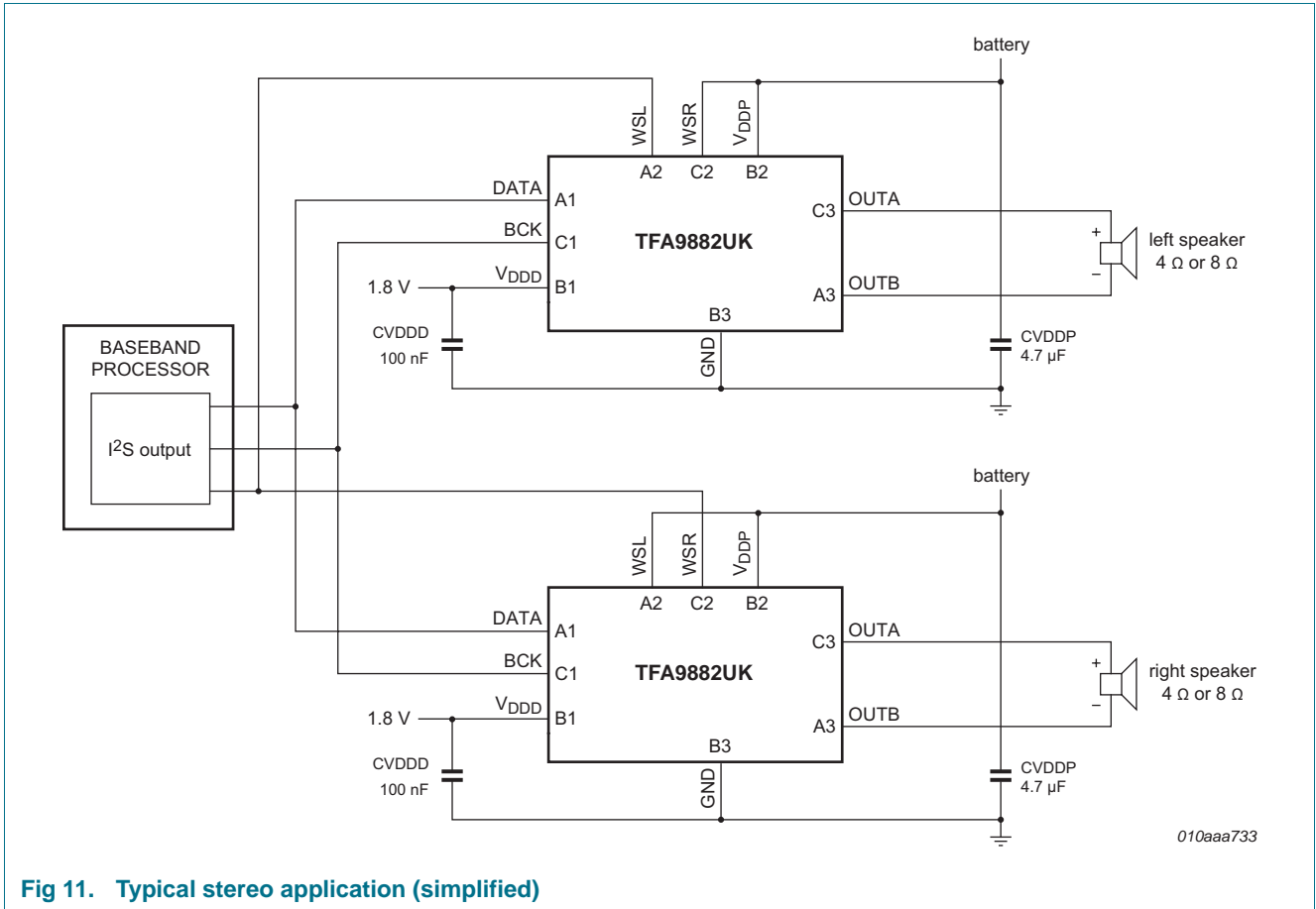
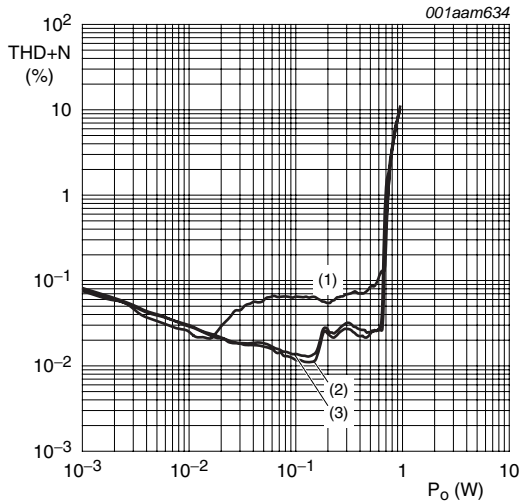

Fig 11. Typical stereo application (simplified)

13.4 Curves measured in reference design (demonstration board)

All measurements were taken with $V_{DD} = 1.8\text{ V}$, $f_{clk} = 6.144\text{ MHz}$, clip control off, DPSA off and slope normal, unless otherwise specified.



- (1) $f_i = 6\text{ kHz}$.
 - (2) $f_i = 1\text{ kHz}$.
 - (3) $f_i = 100\text{ Hz}$.
- a. $V_{DDP} = 3.6\text{ V}$, $R_L = 8\ \Omega$, $L_L = 44\ \mu\text{H}$

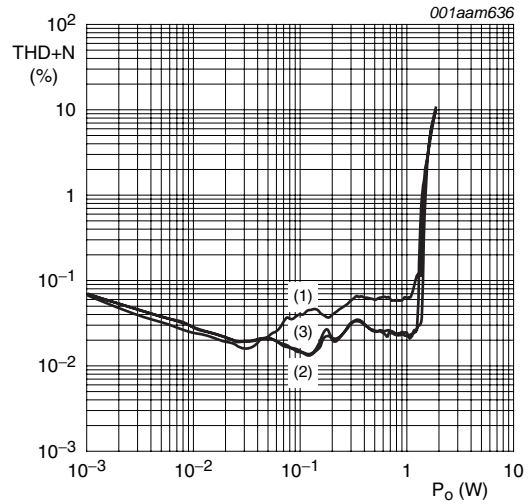

- (1) $f_i = 6\text{ kHz}$.
 - (2) $f_i = 1\text{ kHz}$.
 - (3) $f_i = 100\text{ Hz}$.
- b. $V_{DDP} = 5\text{ V}$, $R_L = 8\ \Omega$, $L_L = 44\ \mu\text{H}$

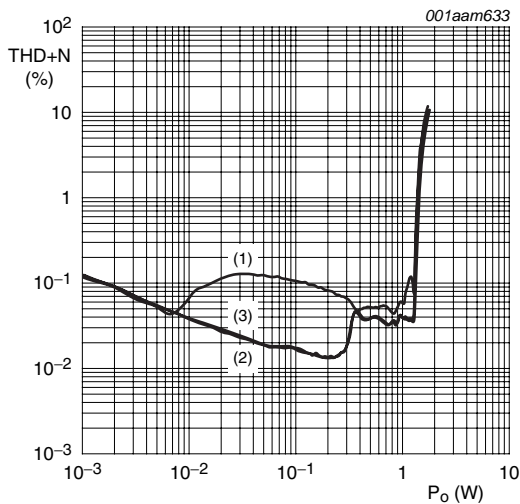

- (1) $f_i = 6\text{ kHz}$.
 - (2) $f_i = 1\text{ kHz}$.
 - (3) $f_i = 100\text{ Hz}$.
- c. $V_{DDP} = 3.6\text{ V}$, $R_L = 4\ \Omega$, $L_L = 20\ \mu\text{H}$

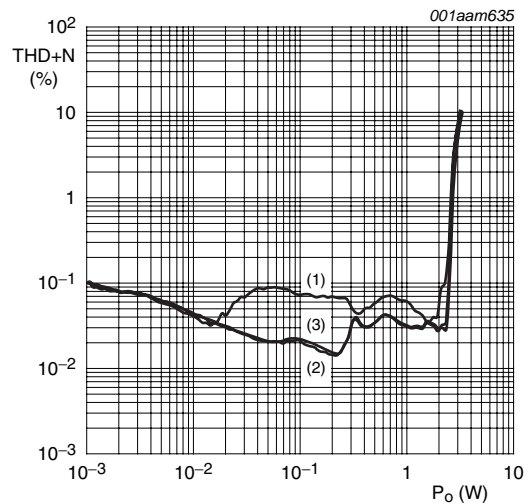

- (1) $f_i = 6\text{ kHz}$.
 - (2) $f_i = 1\text{ kHz}$.
 - (3) $f_i = 100\text{ Hz}$.
- d. $V_{DDP} = 5\text{ V}$, $R_L = 4\ \Omega$, $L_L = 20\ \mu\text{H}$

Fig 12. THD+N as a function of output power

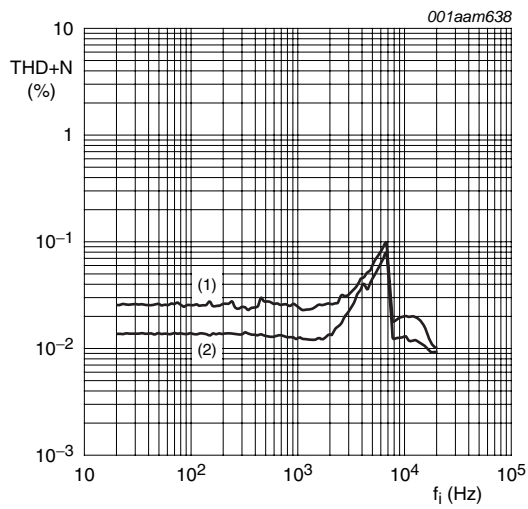

- (1) $P_o = 500 \text{ mW}$
- (2) $P_o = 100 \text{ mW}$
- a. $V_{DDP} = 3.6 \text{ V}, R_L = 8 \Omega, L_L = 44 \mu\text{H}$

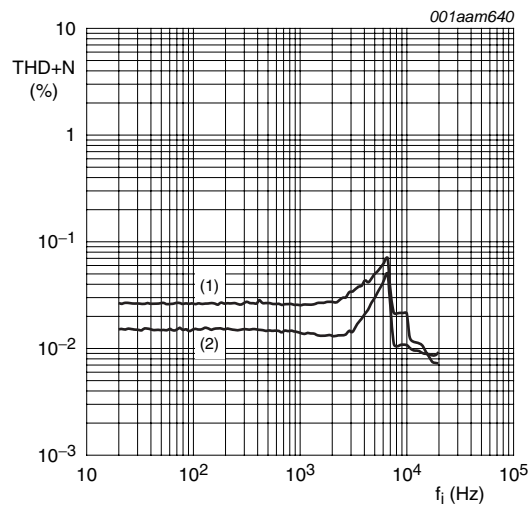

- (1) $P_o = 500 \text{ mW}$
- (2) $P_o = 100 \text{ mW}$
- b. $V_{DDP} = 5 \text{ V}, R_L = 8 \Omega, L_L = 44 \mu\text{H}$

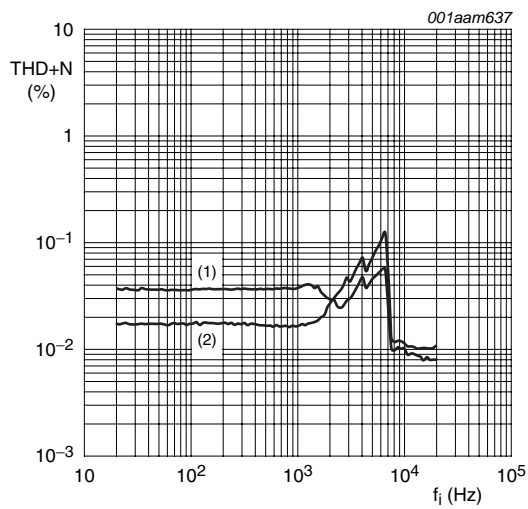

- (1) $P_o = 1\text{W}$
- (2) $P_o = 100 \text{ mW}$
- c. $V_{DDP} = 3.6 \text{ V}, R_L = 4 \Omega, L_L = 20 \mu\text{H}$

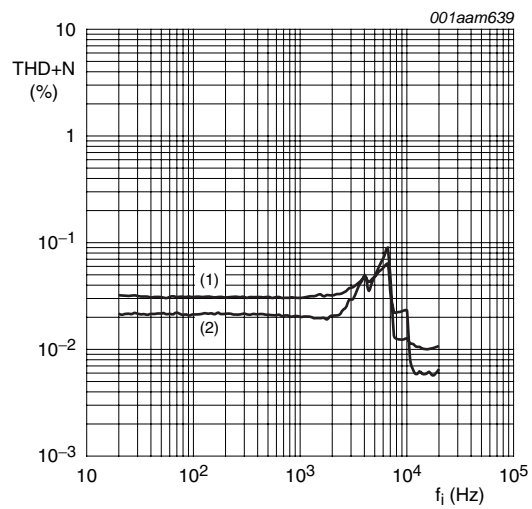

- (1) $P_o = 1\text{W}$
- (2) $P_o = 100 \text{ mW}$
- d. $V_{DDP} = 5 \text{ V}, R_L = 4 \Omega, L_L = 20 \mu\text{H}$

Fig 13. THD+N as a function of frequency

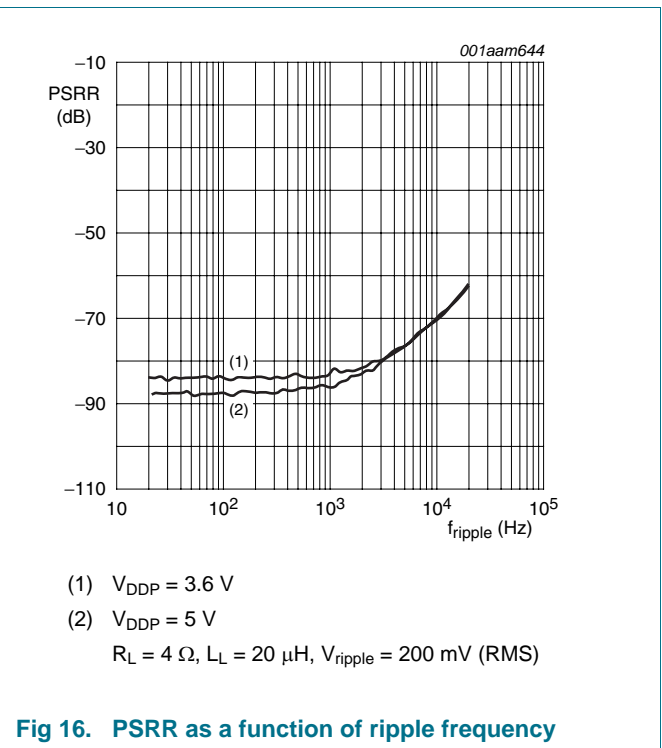
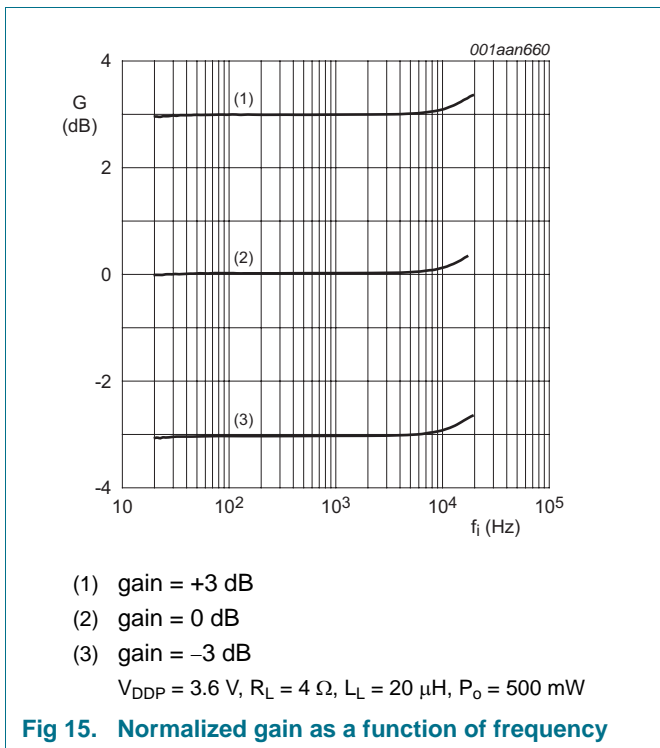
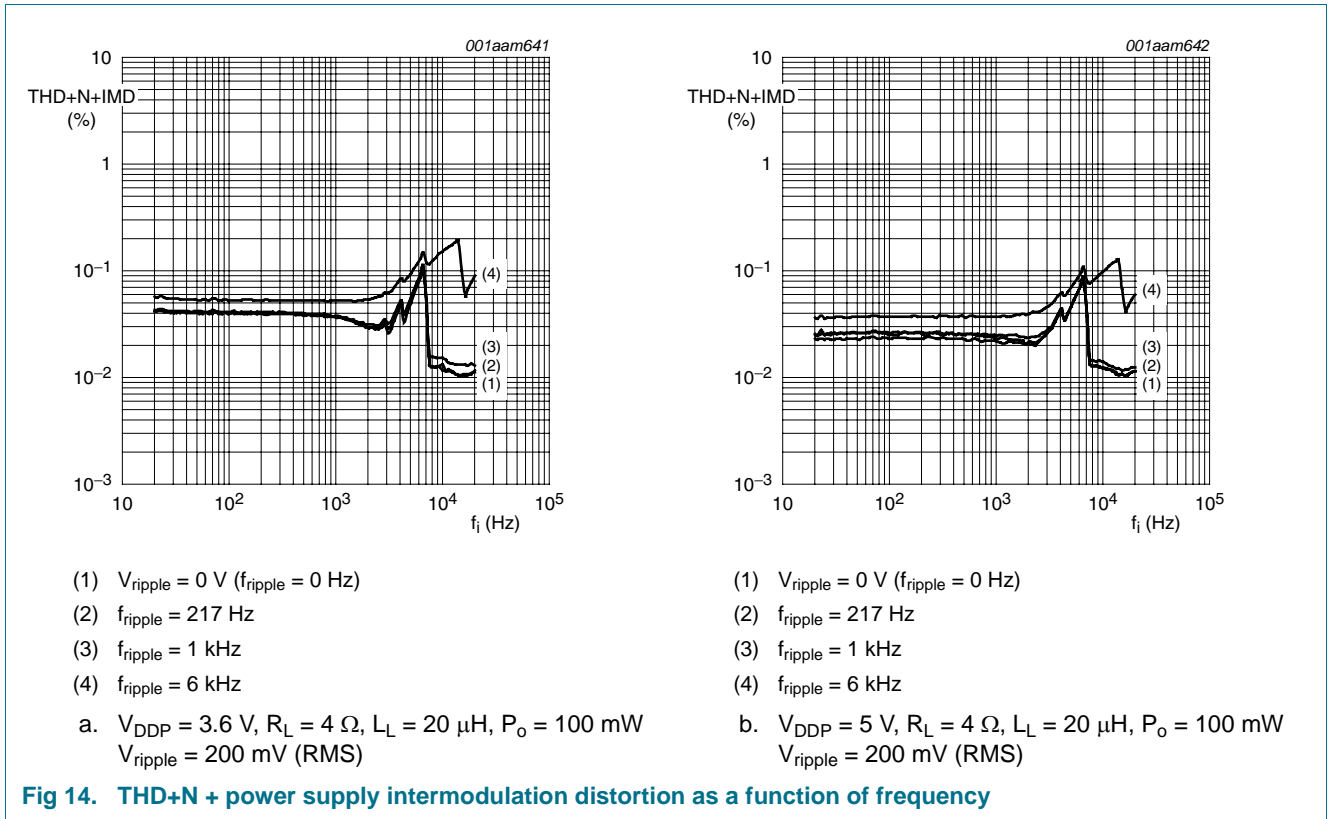

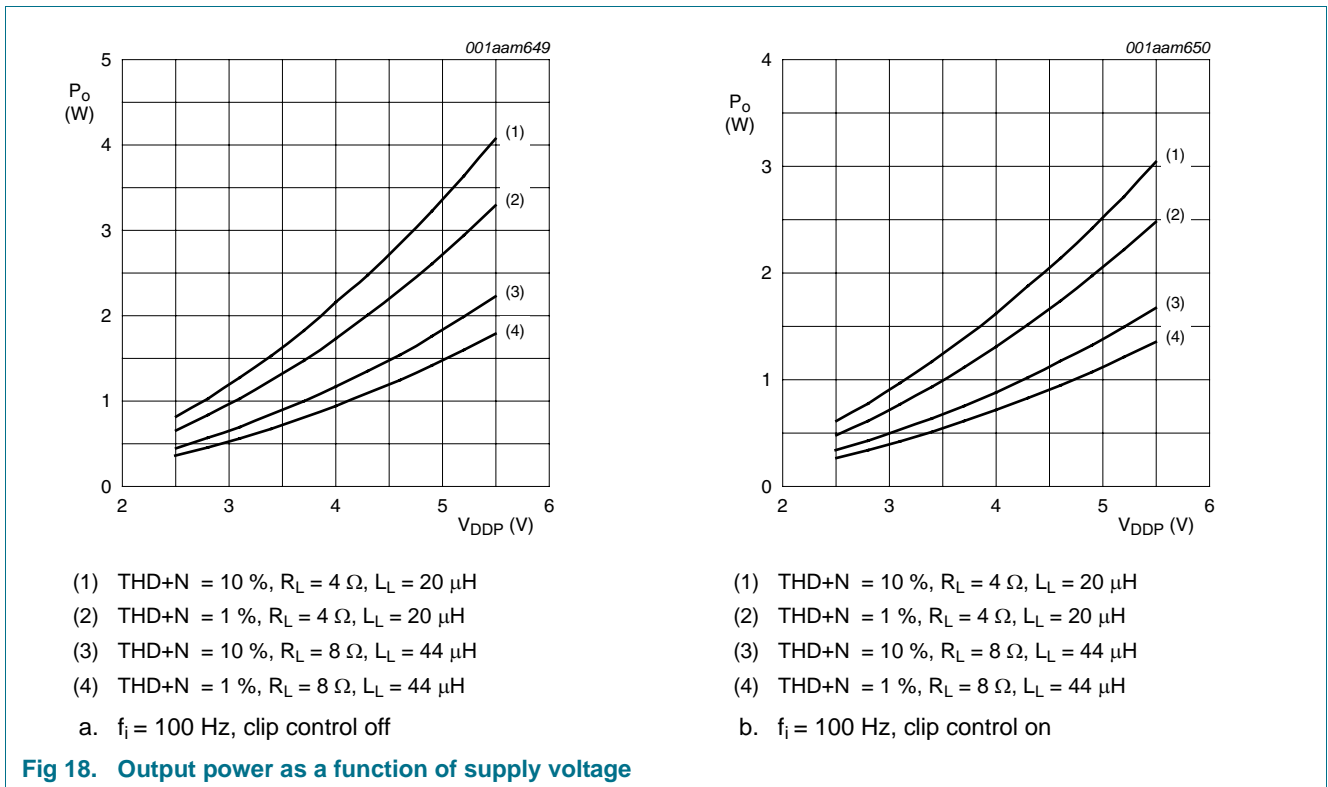
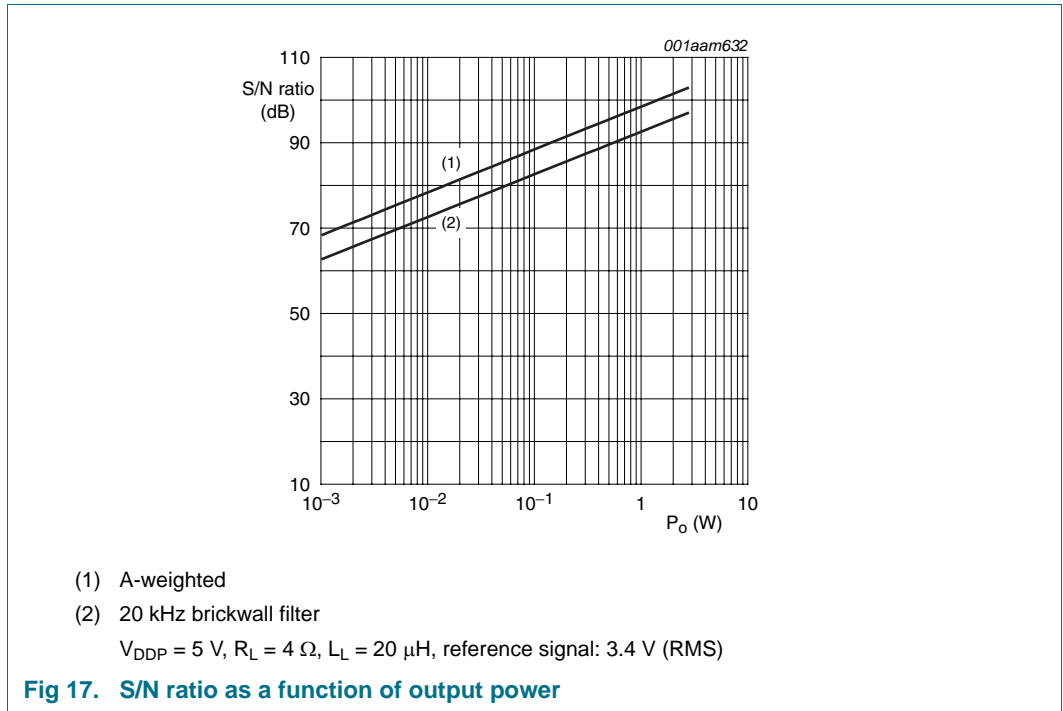

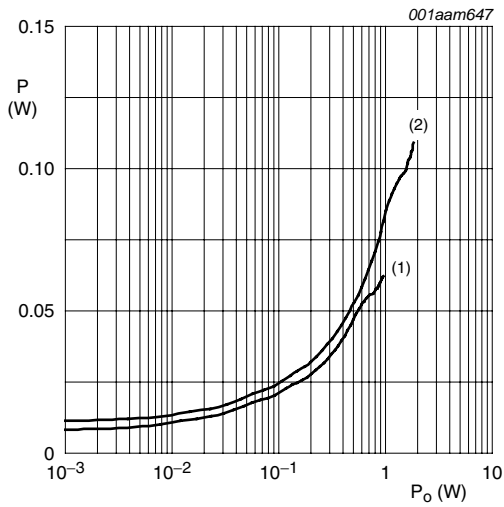

- (1) $V_{DDP} = 3.6\text{ V}$
- (2) $V_{DDP} = 5\text{ V}$
- a. $R_L = 8\ \Omega$, $L_L = 44\ \mu\text{H}$, $f_i = 1\text{ kHz}$, DPSA on

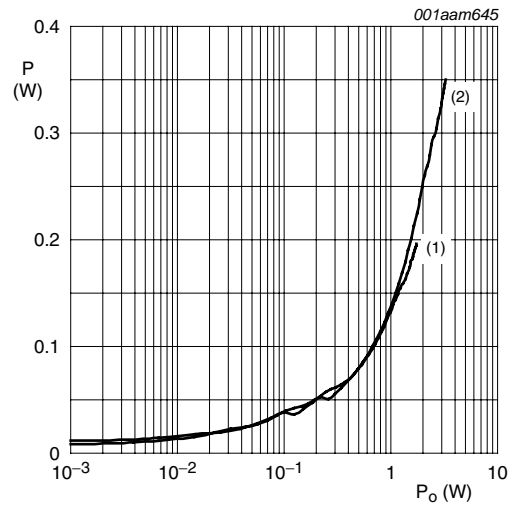

- (1) $V_{DDP} = 3.6\text{ V}$
- (2) $V_{DDP} = 5\text{ V}$
- b. $R_L = 4\ \Omega$, $L_L = 20\ \mu\text{H}$, $f_i = 1\text{ kHz}$, DPSA on

Fig 19. Power dissipation as a function of output power

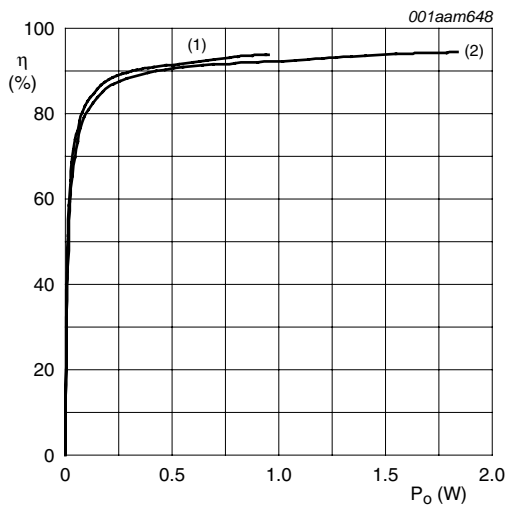

- (1) $V_{DDP} = 3.6\text{ V}$
- (2) $V_{DDP} = 5\text{ V}$
- a. $R_L = 8\ \Omega$, $L_L = 44\ \mu\text{H}$, $f_i = 1\text{ kHz}$, DPSA on

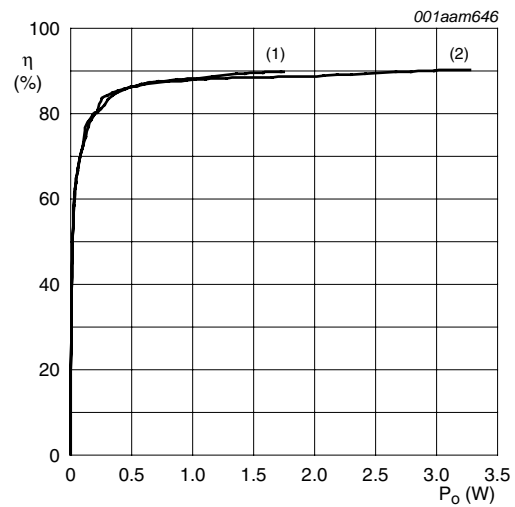

- (1) $V_{DDP} = 3.6\text{ V}$
- (2) $V_{DDP} = 5\text{ V}$
- b. $R_L = 4\ \Omega$, $L_L = 20\ \mu\text{H}$, $f_i = 1\text{ kHz}$, DPSA on

Fig 20. Efficiency as a function of output power

14. Package outline

WLCSP9: wafer level chip-size package; 9 bumps; body 1.49 x 1.27 mm

TFA9882UK

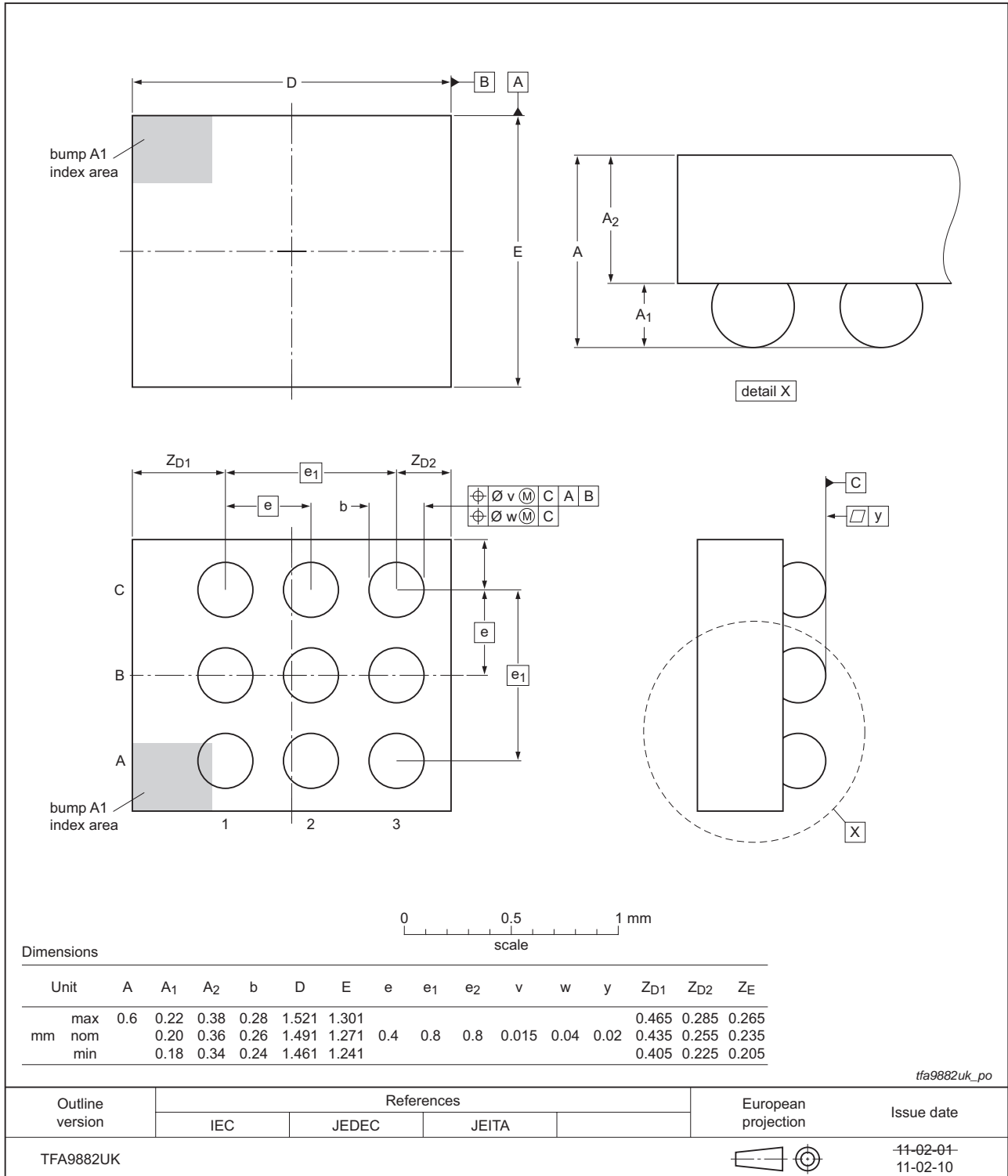

Fig 21. Package outline TFA9882UK (WLCSP9)

15. Soldering of WLCSP packages

15.1 Introduction to soldering WLCSP packages

This text provides a very brief insight into a complex technology. A more in-depth account of soldering WLCSP (Wafer Level Chip-Size Packages) can be found in application note AN10439 "Wafer Level Chip Scale Package" and in application note AN10365 "Surface mount reflow soldering description".

Wave soldering is not suitable for this package.

All NXP WLCSP packages are lead-free.

15.2 Board mounting

Board mounting of a WLCSP requires several steps:

1. Solder paste printing on the PCB
2. Component placement with a pick and place machine
3. The reflow soldering itself

15.3 Reflow soldering

Key characteristics in reflow soldering are:

- Lead-free versus SnPb soldering; note that a lead-free reflow process usually leads to higher minimum peak temperatures (see [Figure 22](#)) than a PbSn process, thus reducing the process window
- Solder paste printing issues, such as smearing, release, and adjusting the process window for a mix of large and small components on one board
- Reflow temperature profile; this profile includes preheat, reflow (in which the board is heated to the peak temperature), and cooling down. It is imperative that the peak temperature is high enough for the solder to make reliable solder joints (a solder paste characteristic) while being low enough that the packages and/or boards are not damaged. The peak temperature of the package depends on package thickness and volume and is classified in accordance with [Table 17](#).

Table 17. Lead-free process (from J-STD-020C)

Package thickness (mm)	Package reflow temperature (°C)		
	Volume (mm ³)		
	< 350	350 to 2000	> 2000
< 1.6	260	260	260
1.6 to 2.5	260	250	245
> 2.5	250	245	245

Moisture sensitivity precautions, as indicated on the packing, must be respected at all times.

Studies have shown that small packages reach higher temperatures during reflow soldering, see [Figure 22](#).

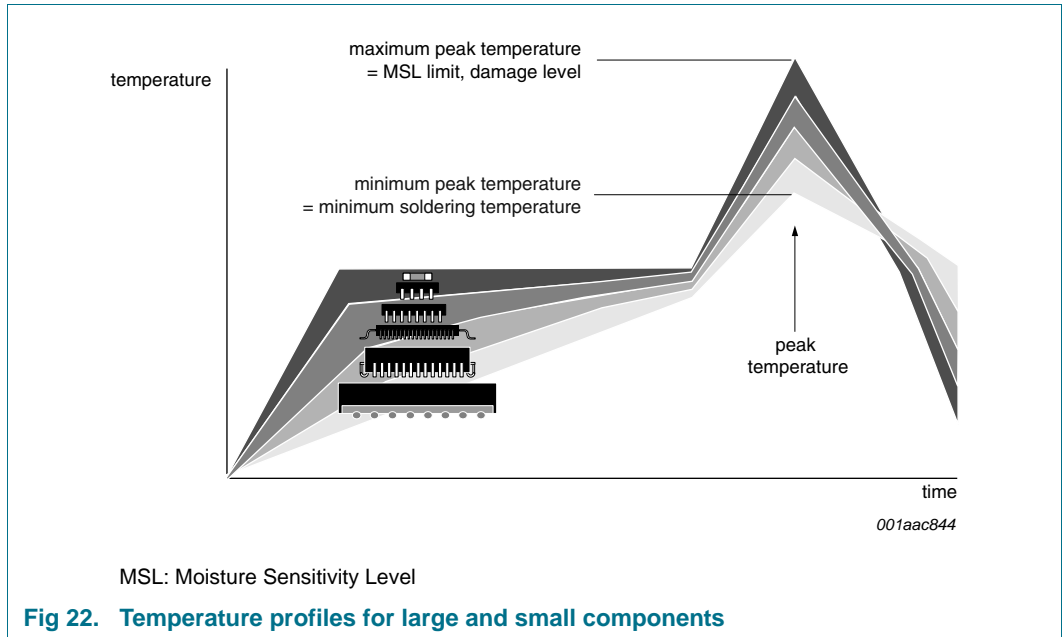

For further information on temperature profiles, refer to application note AN10365 “Surface mount reflow soldering description”.

15.3.1 Stand off

The stand off between the substrate and the chip is determined by:

- The amount of printed solder on the substrate
- The size of the solder land on the substrate
- The bump height on the chip

The higher the stand off, the better the stresses are released due to TEC (Thermal Expansion Coefficient) differences between substrate and chip.

15.3.2 Quality of solder joint

A flip-chip joint is considered to be a good joint when the entire solder land has been wetted by the solder from the bump. The surface of the joint should be smooth and the shape symmetrical. The soldered joints on a chip should be uniform. Voids in the bumps after reflow can occur during the reflow process in bumps with high ratio of bump diameter to bump height, i.e. low bumps with large diameter. No failures have been found to be related to these voids. Solder joint inspection after reflow can be done with X-ray to monitor defects such as bridging, open circuits and voids.

15.3.3 Rework

In general, rework is not recommended. By rework we mean the process of removing the chip from the substrate and replacing it with a new chip. If a chip is removed from the substrate, most solder balls of the chip will be damaged. In that case it is recommended not to re-use the chip again.

Device removal can be done when the substrate is heated until it is certain that all solder joints are molten. The chip can then be carefully removed from the substrate without damaging the tracks and solder lands on the substrate. Removing the device must be done using plastic tweezers, because metal tweezers can damage the silicon. The surface of the substrate should be carefully cleaned and all solder and flux residues and/or underfill removed. When a new chip is placed on the substrate, use the flux process instead of solder on the solder lands. Apply flux on the bumps at the chip side as well as on the solder pads on the substrate. Place and align the new chip while viewing with a microscope. To reflow the solder, use the solder profile shown in application note AN10365 "Surface mount reflow soldering description".

15.3.4 Cleaning

Cleaning can be done after reflow soldering.

16. Revision history

Table 18. Revision history

Document ID	Release date	Data sheet status	Change notice	Supersedes
TFA9882 v.2	20110420	Product data sheet		TFA9882 v.1
Modifications:	• Data sheet status changed to 'Product data sheet'			
TFA9882 v.1	20110331	Preliminary data sheet	-	-

17. Legal information

17.1 Data sheet status

Document status ^{[1][2]}	Product status ^[3]	Definition
Objective [short] data sheet	Development	This document contains data from the objective specification for product development.
Preliminary [short] data sheet	Qualification	This document contains data from the preliminary specification.
Product [short] data sheet	Production	This document contains the product specification.

[1] Please consult the most recently issued document before initiating or completing a design.

[2] The term 'short data sheet' is explained in section "Definitions".

[3] The product status of device(s) described in this document may have changed since this document was published and may differ in case of multiple devices. The latest product status information is available on the Internet at URL <http://www.nxp.com>.

17.2 Definitions

Draft — The document is a draft version only. The content is still under internal review and subject to formal approval, which may result in modifications or additions. NXP Semiconductors does not give any representations or warranties as to the accuracy or completeness of information included herein and shall have no liability for the consequences of use of such information.

Short data sheet — A short data sheet is an extract from a full data sheet with the same product type number(s) and title. A short data sheet is intended for quick reference only and should not be relied upon to contain detailed and full information. For detailed and full information see the relevant full data sheet, which is available on request via the local NXP Semiconductors sales office. In case of any inconsistency or conflict with the short data sheet, the full data sheet shall prevail.

Product specification — The information and data provided in a Product data sheet shall define the specification of the product as agreed between NXP Semiconductors and its customer, unless NXP Semiconductors and customer have explicitly agreed otherwise in writing. In no event however, shall an agreement be valid in which the NXP Semiconductors product is deemed to offer functions and qualities beyond those described in the Product data sheet.

17.3 Disclaimers

Limited warranty and liability — Information in this document is believed to be accurate and reliable. However, NXP Semiconductors does not give any representations or warranties, expressed or implied, as to the accuracy or completeness of such information and shall have no liability for the consequences of use of such information.

In no event shall NXP Semiconductors be liable for any indirect, incidental, punitive, special or consequential damages (including - without limitation - lost profits, lost savings, business interruption, costs related to the removal or replacement of any products or rework charges) whether or not such damages are based on tort (including negligence), warranty, breach of contract or any other legal theory.

Notwithstanding any damages that customer might incur for any reason whatsoever, NXP Semiconductors' aggregate and cumulative liability towards customer for the products described herein shall be limited in accordance with the *Terms and conditions of commercial sale* of NXP Semiconductors.

Right to make changes — NXP Semiconductors reserves the right to make changes to information published in this document, including without limitation specifications and product descriptions, at any time and without notice. This document supersedes and replaces all information supplied prior to the publication hereof.

Suitability for use — NXP Semiconductors products are not designed, authorized or warranted to be suitable for use in life support, life-critical or safety-critical systems or equipment, nor in applications where failure or

malfunction of an NXP Semiconductors product can reasonably be expected to result in personal injury, death or severe property or environmental damage. NXP Semiconductors accepts no liability for inclusion and/or use of NXP Semiconductors products in such equipment or applications and therefore such inclusion and/or use is at the customer's own risk.

Applications — Applications that are described herein for any of these products are for illustrative purposes only. NXP Semiconductors makes no representation or warranty that such applications will be suitable for the specified use without further testing or modification.

Customers are responsible for the design and operation of their applications and products using NXP Semiconductors products, and NXP Semiconductors accepts no liability for any assistance with applications or customer product design. It is customer's sole responsibility to determine whether the NXP Semiconductors product is suitable and fit for the customer's applications and products planned, as well as for the planned application and use of customer's third party customer(s). Customers should provide appropriate design and operating safeguards to minimize the risks associated with their applications and products.

NXP Semiconductors does not accept any liability related to any default, damage, costs or problem which is based on any weakness or default in the customer's applications or products, or the application or use by customer's third party customer(s). Customer is responsible for doing all necessary testing for the customer's applications and products using NXP Semiconductors products in order to avoid a default of the applications and the products or of the application or use by customer's third party customer(s). NXP does not accept any liability in this respect.

Limiting values — Stress above one or more limiting values (as defined in the Absolute Maximum Ratings System of IEC 60134) will cause permanent damage to the device. Limiting values are stress ratings only and (proper) operation of the device at these or any other conditions above those given in the Recommended operating conditions section (if present) or the Characteristics sections of this document is not warranted. Constant or repeated exposure to limiting values will permanently and irreversibly affect the quality and reliability of the device.

Terms and conditions of commercial sale — NXP Semiconductors products are sold subject to the general terms and conditions of commercial sale, as published at <http://www.nxp.com/profile/terms>, unless otherwise agreed in a valid written individual agreement. In case an individual agreement is concluded only the terms and conditions of the respective agreement shall apply. NXP Semiconductors hereby expressly objects to applying the customer's general terms and conditions with regard to the purchase of NXP Semiconductors products by customer.

No offer to sell or license — Nothing in this document may be interpreted or construed as an offer to sell products that is open for acceptance or the grant, conveyance or implication of any license under any copyrights, patents or other industrial or intellectual property rights.

Export control — This document as well as the item(s) described herein may be subject to export control regulations. Export might require a prior authorization from national authorities.

Quick reference data — The Quick reference data is an extract of the product data given in the Limiting values and Characteristics sections of this document, and as such is not complete, exhaustive or legally binding.

Non-automotive qualified products — Unless this data sheet expressly states that this specific NXP Semiconductors product is automotive qualified, the product is not suitable for automotive use. It is neither qualified nor tested in accordance with automotive testing or application requirements. NXP Semiconductors accepts no liability for inclusion and/or use of non-automotive qualified products in automotive equipment or applications.

In the event that customer uses the product for design-in and use in automotive applications to automotive specifications and standards, customer (a) shall use the product without NXP Semiconductors' warranty of the

product for such automotive applications, use and specifications, and (b) whenever customer uses the product for automotive applications beyond NXP Semiconductors' specifications such use shall be solely at customer's own risk, and (c) customer fully indemnifies NXP Semiconductors for any liability, damages or failed product claims resulting from customer design and use of the product for automotive applications beyond NXP Semiconductors' standard warranty and NXP Semiconductors' product specifications.

17.4 Trademarks

Notice: All referenced brands, product names, service names and trademarks are the property of their respective owners.

18. Contact information

For more information, please visit: <http://www.nxp.com>

For sales office addresses, please send an email to: salesaddresses@nxp.com

19. Contents

1	General description	1	15.2	Board mounting	25
2	Features and benefits	1	15.3	Reflow soldering	25
3	Applications	2	15.3.1	Stand off	26
4	Quick reference data	2	15.3.2	Quality of solder joint	26
5	Ordering information	3	15.3.3	Rework	26
6	Block diagram	3	15.3.4	Cleaning	27
7	Pinning information	4	16	Revision history	28
7.1	Pinning	4	17	Legal information	29
7.2	Pin description	4	17.1	Data sheet status	29
8	Functional description	5	17.2	Definitions	29
8.1	Mode selection and interfacing	5	17.3	Disclaimers	29
8.2	I ² S format	6	17.4	Trademarks	30
8.3	Power-up/power-down sequence	6	18	Contact information	30
8.4	Control settings	7	19	Contents	31
8.4.1	Control setting pattern recognition	7			
8.4.2	Clip control	8			
8.4.3	Gain selection	8			
8.4.4	PWM slope selection	8			
8.4.5	Dynamic Power Stage Activation (DPSA)	8			
8.5	High-pass filter	9			
8.6	PWM frequency	9			
8.7	Bandwidth	10			
8.8	Protection mechanisms	10			
8.8.1	OverTemperature Protection (OTP)	10			
8.8.2	Supply voltage protection mechanisms (UVP and OVP)	11			
8.8.3	OverCurrent Protection (OCP)	11			
9	Internal circuitry	12			
10	Limiting values	12			
11	Thermal characteristics	13			
12	Characteristics	13			
12.1	DC characteristics	13			
12.2	AC characteristics	15			
12.3	I ² S timing characteristics	16			
13	Application information	17			
13.1	ElectroMagnetic Compatibility (EMC)	17			
13.1.1	Immunity	17			
13.1.2	Emissions	17			
13.2	Supply decoupling and filtering	17			
13.3	Typical application diagram (simplified)	18			
13.4	Curves measured in reference design (demonstration board)	19			
14	Package outline	24			
15	Soldering of WLCSP packages	25			
15.1	Introduction to soldering WLCSP packages ..	25			

Please be aware that important notices concerning this document and the product(s) described herein, have been included in section 'Legal information'.

© NXP B.V. 2011.

All rights reserved.

For more information, please visit: <http://www.nxp.com>

For sales office addresses, please send an email to: salesaddresses@nxp.com

Date of release: 20 April 2011

Document identifier: TFA9882