

**TV Sound IF or FM IF Amplifier  
with Quadrature Detector**

**IF AMPLIFIER  
WITH QUADRATURE  
DETECTOR**

**SILICON MONOLITHIC  
INTEGRATED CIRCUIT**

- A Direct Replacement for the ULN211A
- Greatly Simplified FM Demodulator Alignment
- Excellent Performance at  $V_{CC} = 8.0$  Vdc

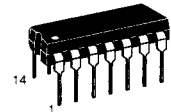

**P SUFFIX**  
**PLASTIC PACKAGE**  
**CASE 646**

**Figure 1. TV Typical Application Circuit**

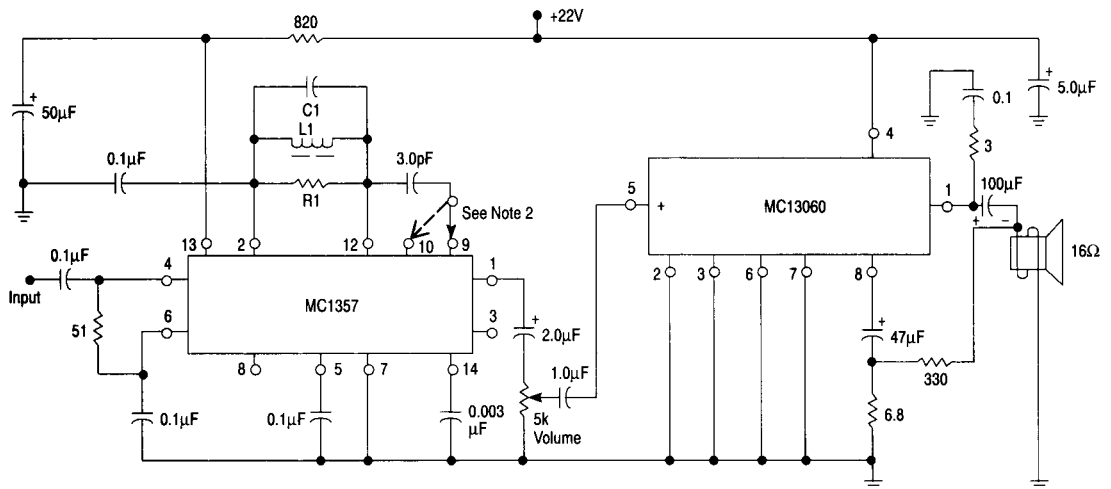

**Typical Performance**  
2.0 W Output  
2% Distortion  
250  $\mu$ V Sensitivity (3 dB Lim.)

C1 = 120 pF  
L1 = 14  $\mu$ H  
R1 = 20 k $\Omega$   
Q = 30

## MC1357

**MAXIMUM RATINGS** ( $T_A = +25^\circ\text{C}$ , unless otherwise noted.)

Rating	Value	Unit
Power Supply Voltage	16	Vdc
Input Voltage (Pin 4)	3.5	Vp
Power Dissipation (Package Limitation) Plastic Package Derate above $T_A = +25^\circ\text{C}$	625 5.0	mW mW/ $^\circ\text{C}$
Operating Temperature Range (Ambient)	0 to +70	$^\circ\text{C}$
Storage Temperature Range	-65 to +150	$^\circ\text{C}$

**ELECTRICAL CHARACTERISTICS** ( $V_{CC} = 12\text{ Vdc}$ ,  $T_A = +25^\circ\text{C}$ , unless otherwise noted.)

Characteristics	Pin	Min	Typ	Max	Unit
Drain Current $V_{CC} = 8.0\text{ V}$ $V_{CC} = 12\text{ V}$	13	10 —	12 15	19 21	mA
Amplifier Input Reference Voltage	6	—	1.45	—	Vdc
Detector Input Reference Voltage	2	—	3.65	—	Vdc
Amplifier High Level Output Voltage	10	1.25	1.45	1.65	Vdc
Amplifier Low Level Output Voltage	9	—	0.145	0.2	Vdc
Detector Output Voltage $V_{CC} = 8.0\text{ V}$ $V_{CC} = 12\text{ V}$	1	— —	3.7 5.4	— —	Vdc
Amplifier Input Resistance	4	—	5.0	—	k $\Omega$
Amplifier Input Capacitance	4	—	11	—	pF
Detector Input Resistance	12	—	70	—	k $\Omega$
Detector Input Capacitance	12	—	2.7	—	pF
Amplifier Output Resistance	10	—	60	—	$\Omega$
Detector Output Resistance	1	—	200	—	$\Omega$
De-Emphasis Resistance	14	—	8.8	—	k $\Omega$

**DYNAMIC CHARACTERISTICS** FM Modulation Frequency = 1.0 kHz, Source Resistance = 50  $\Omega$ ,  $T_A = +25^\circ\text{C}$  for all tests.( $V_{CC} = 12\text{ Vdc}$ ,  $f_o = 4.5\text{ MHz}$ ,  $\Delta f = \pm 25\text{ kHz}$ , Peak Separation = 150 kHz)

Characteristics	Pin	Min	Typ	Max	Unit
Amplifier Voltage Gain ( $V_{in} \leq 50\ \mu\text{V[rms]}$ )	10	—	60	—	dB
AM Rejection* ( $V_{in} = 10\text{ mV[rms]}$ )	1	—	36	—	dB
Input Limiting Threshold Voltage	4	—	250	—	$\mu\text{Vrms}$
Recovered Audio Output Voltage ( $V_{in} = 10\text{ mV[rms]}$ )	1	—	0.72	—	Vrms
Output Distortion ( $V_{in} = 10\text{ mV[rms]}$ )	1	—	3.0	—	%

( $V_{CC} = 12\text{ Vdc}$ ,  $f_o = 5.5\text{ MHz}$ ,  $\Delta f = \pm 50\text{ kHz}$ , Peak Separation = 260 kHz)

Amplifier Voltage Gain ( $V_{in} \leq 50\ \mu\text{V[rms]}$ )	10	—	60	—	dB
AM Rejection* ( $V_{in} = 10\text{ mV[rms]}$ )	1	—	40	—	dB
Input Limiting Threshold Voltage	4	—	250	—	$\mu\text{Vrms}$
Recovered Audio Output Voltage ( $V_{in} = 10\text{ mV[rms]}$ )	1	—	1.2	—	Vrms
Output Distortion ( $V_{in} = 10\text{ mV[rms]}$ )	1	—	5.0	—	%

( $V_{CC} = 8.0\text{ Vdc}$ ,  $f_o = 10.7\text{ MHz}$ ,  $\Delta f = \pm 75\text{ kHz}$ , Peak Separation = 550 kHz)

Amplifier Voltage Gain ( $V_{in} \leq 50\ \mu\text{V[rms]}$ )	10	—	53	—	dB
AM Rejection* ( $V_{in} = 10\text{ mV[rms]}$ )	1	—	37	—	dB
Input Limiting Threshold Voltage	4	—	600	—	$\mu\text{Vrms}$
Recovered Audio Output Voltage ( $V_{in} = 10\text{ mV[rms]}$ )	1	—	0.3	—	Vrms
Output Distortion ( $V_{in} = 10\text{ mV[rms]}$ )	1	—	1.4	—	%

( $V_{CC} = 12\text{ Vdc}$ ,  $f_o = 10.7\text{ MHz}$ ,  $\Delta f = \pm 75\text{ kHz}$ , Peak Separation = 550 kHz)

Amplifier Voltage Gain ( $V_{in} \leq 50\ \mu\text{V[rms]}$ )	10	—	53	—	dB
AM Rejection* ( $V_{in} = 10\text{ mV[rms]}$ )	1	—	45	—	dB
Input Limiting Threshold Voltage	4	—	600	—	$\mu\text{Vrms}$
Recovered Audio Output Voltage ( $V_{in} = 10\text{ mV[rms]}$ )	1	—	0.48	—	Vrms
Output Distortion ( $V_{in} = 10\text{ mV[rms]}$ )	1	—	1.4	—	%

**NOTE:** \*100% FM, 30% AM Modulation

# MC1357

## TYPICAL CHARACTERISTICS

( $V_{CC} = 12\text{ V}$ ,  $T_A = +25^\circ\text{C}$ , unless otherwise noted.)  
 (Use Test Circuit of Figure 13)

Figure 2. AM Rejection

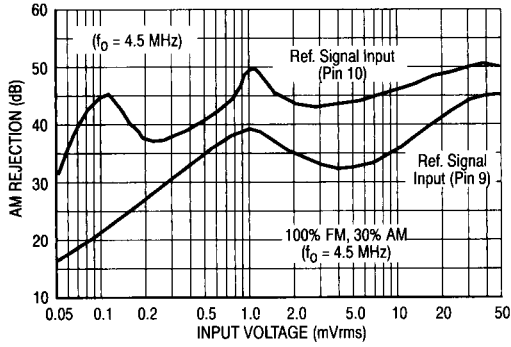

Figure 3. AM Rejection

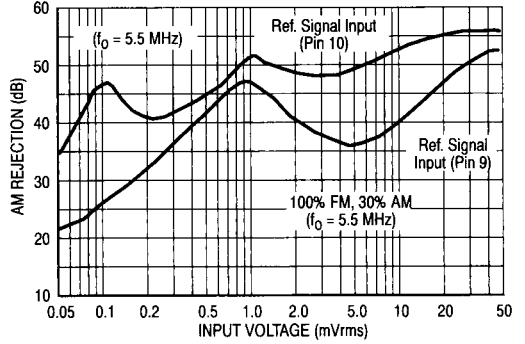

Figure 4. Detected Audio Output

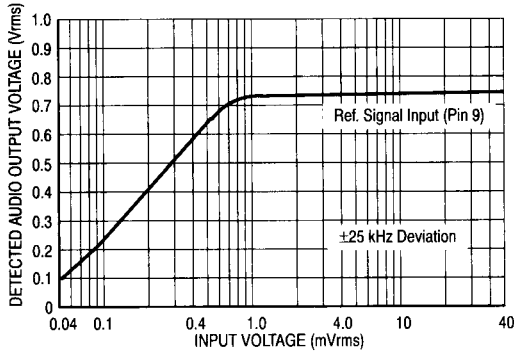

Figure 5. Detected Audio Output

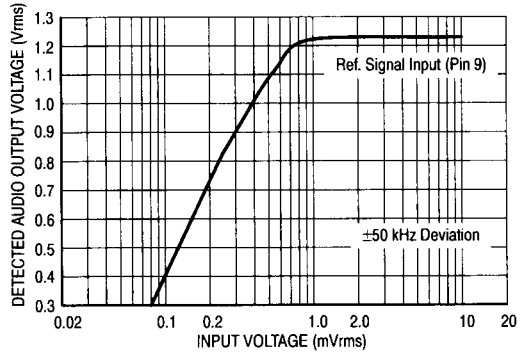

Figure 6. Detector Transfer Characteristic

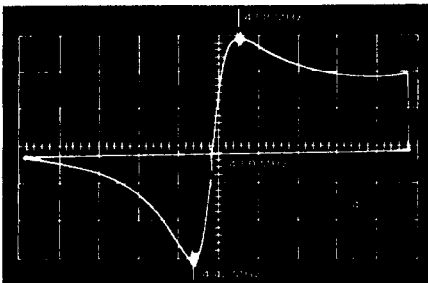
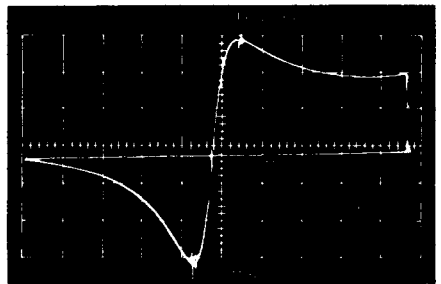
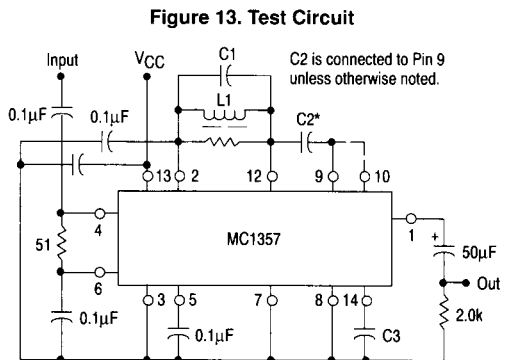
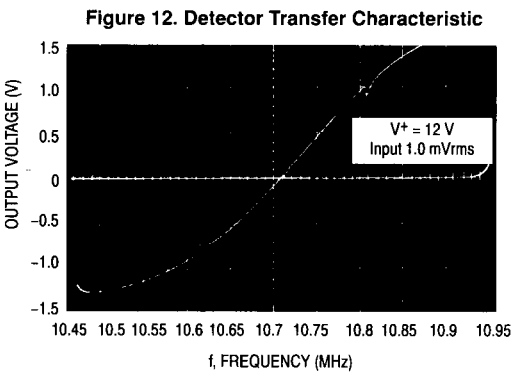
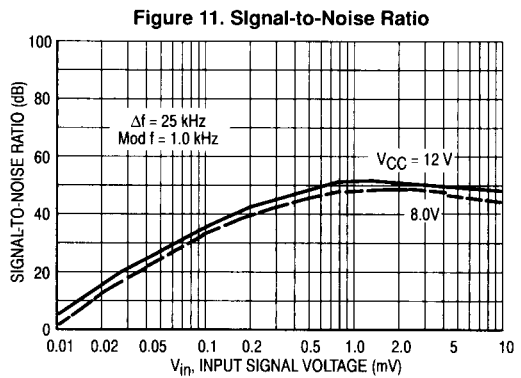
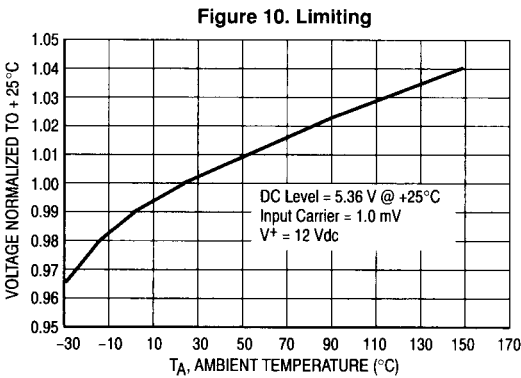
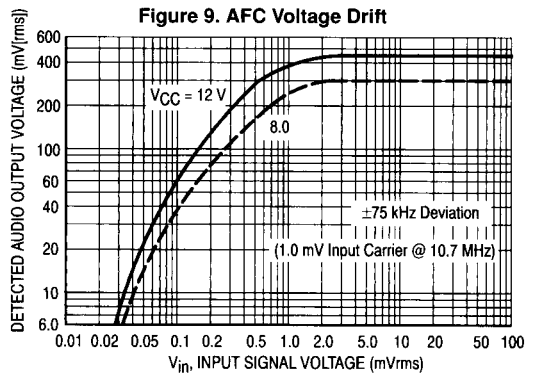
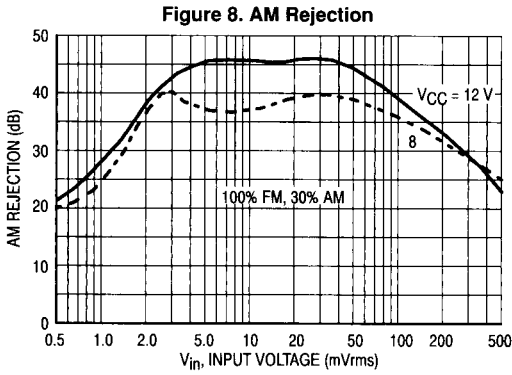

Figure 7. Detector Transfer Characteristic



# MC1357

**TYPICAL CHARACTERISTICS** (continued)  
 ( $f_o = 10.7 \text{ MHz}$ ,  $T_A = +25^\circ\text{C}$ , unless otherwise noted.)  
 (Use Test Circuit of Figure 13)



**COMPONENT VALUES**

f	L1	C1	R1	Q(R1,L1)	C2	C3
MHz	μH	pF	kΩ		pF	μF
4.5	14	120	20	30	3.0	0.003
5.5	8.0	100	20	30	3.0	0.003
10.7	2.0	120	3.9	20	4.7	0.01

# MC1357

Figure 14. FM Radio Typical Application Circuit

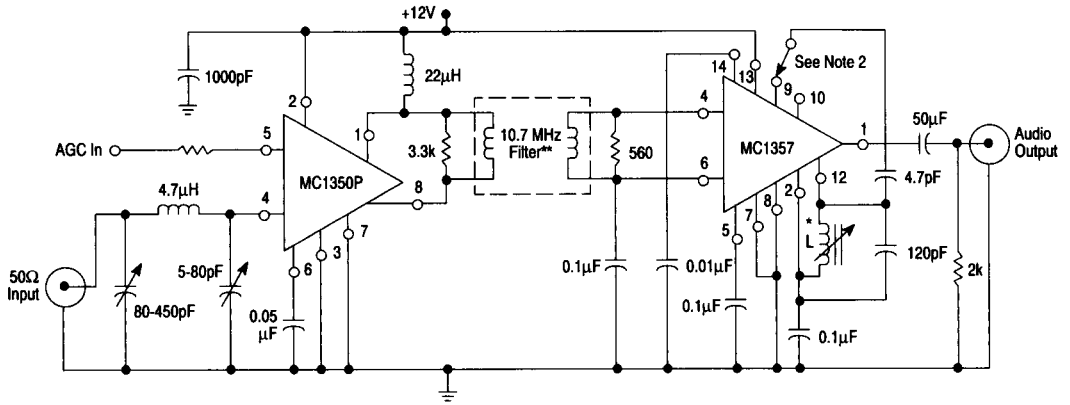

Note 1:  
Information shown in Figures 15, 16, and 17 was obtained using the circuit of Figure 14.

Note 2:  
Optional input to the quadrature coil may be from either Pin 9 or Pin 10 in the application shown. Pin 9 has commonly been used on this type of part to avoid overload with various tuning techniques. For this reason, Pin 9 is used in tests on the preceding pages (except as noted). However, a significant improvement of limiting sensitivity can be obtained using Pin 10, see Figure 17, and no overload problems have been incurred with this tuned circuit configuration.

Figure 15. Output Distortion

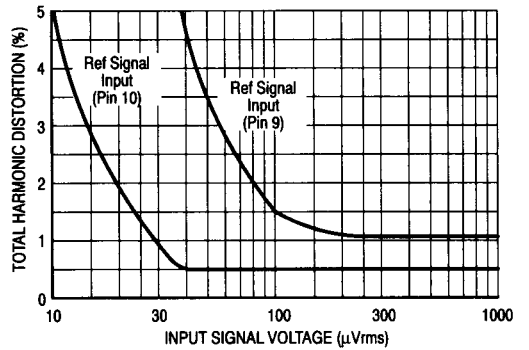

Figure 16. Signal-to-Noise Ratio

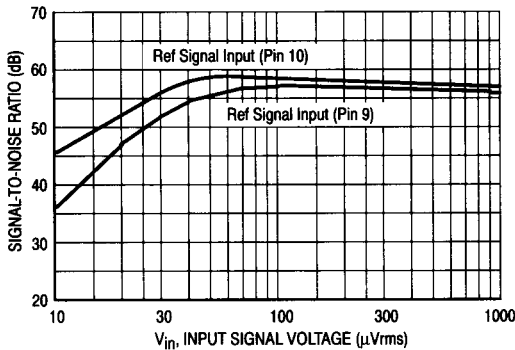
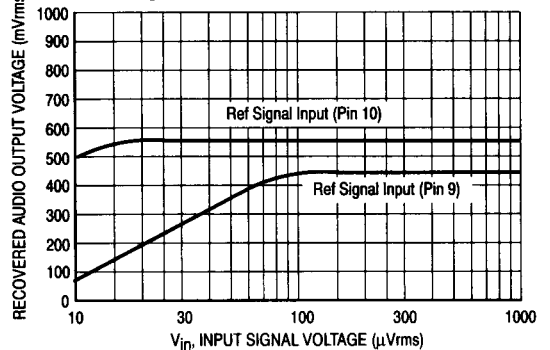

Figure 17. Recovered Audio Output



# MC1357

Figure 18. Circuit Schematic

