



PRODUCT SPECIFICATION

Model No : CSM-57131A9/CSM-57141A9

Descriptions:

- 1.2Inch Dot-Matrix Display
- 5*7 Array with X-Y Select.
- CSM-57131: Column Anode, Row Cathode
- CSM-57141: Column Cathode, Row Anode
- Emitting Color: Super-Bright Amber



CUSTOMER APPROVED SIGNATURES	APPROVED BY	CHECKED BY	PREPARED BY

CHINA SEMICONDUCTOR CORPORATION

Address:2FL. NO.909,Chung-Cheng Road,
Chung-Ho City Taipei Hsien,Taiwan.

Tel:886-2-2223-9696
Fax:886-2-2223-9377

OPTO PLUS TECHNOLOGIES CO.,LTD

Address:696 Shun jiang Rd.,Ji Shan St.Shaoxing,
ZheJiang,China

Tel:86-0575-88623888
Fax:86-0575-88623112



Model No : CSM-57131A9/CSM-57141A9

Features -

1. 1.2 inch (30.3mm) Matrix height.
2. Case mold type.
3. RoHS compliant.
4. Low power consumption.
5. Easy mounting on P.C. board or socket.

Device Selection Guide -

Part No.	Chip		Column	Row
	Material	Emitted Color		
CSM-57131A9	AlGaInP	Super-Bright Amber	Anode	Cathode
CSM-57141A9			Cathode	Anode

Package Dimensions -

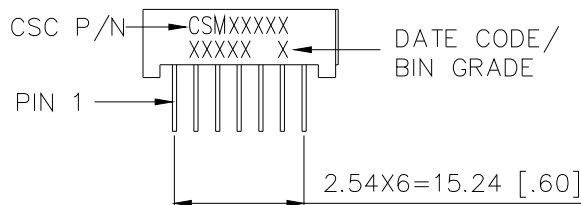
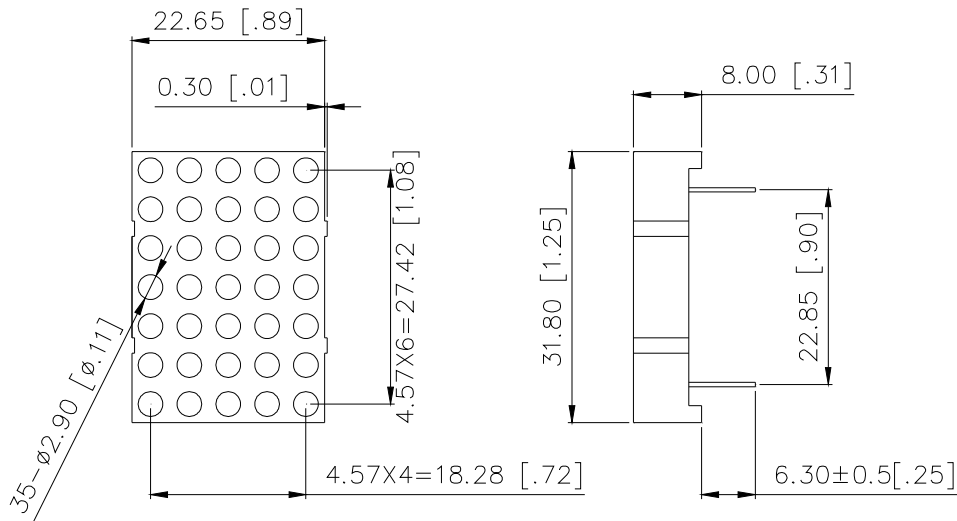

NOTE:

- 1 All pins are ø0.5(.02).
- 2 Dimension in millimeters (inch), tolerance is ±0.25 (.01) unless otherwise noted.



Model No : CSM-57131A9/CSM-57141A9

Internal Circuit Diagrams -

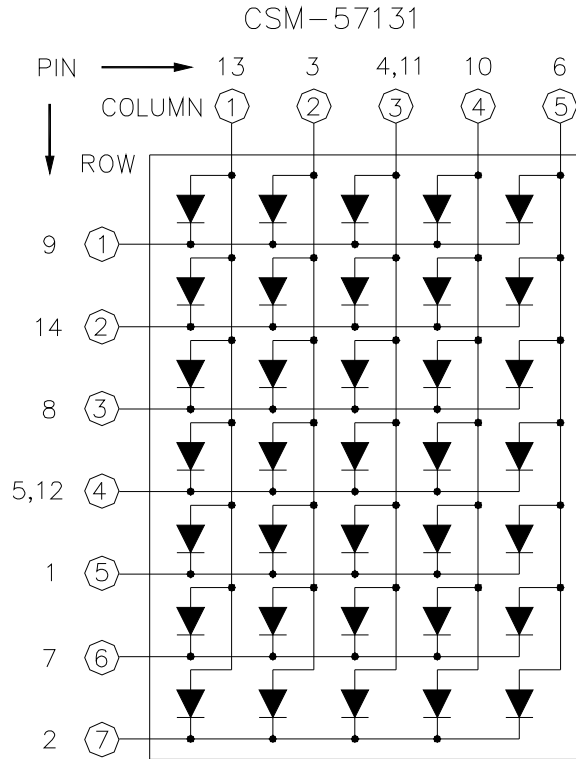

CSM-57131			
PIN NO.	FUNCTION	PIN NO.	FUNCTION
1	Cathode Row 5	8	Cathode Row 3
2	Cathode Row 7	9	Cathode Row 1
3	Anode Column 2	10	Anode Column 4
4	Anode Column 3	11	Anode Column 3
5	Cathode Row 4	12	Cathode Row 4
6	Anode Column 5	13	Anode Column 1
7	Cathode Row 6	14	Cathode Row 2

CSM-57141			
PIN NO.	FUNCTION	PIN NO.	FUNCTION
1	Anode Row 5	8	Anode Row 3
2	Anode Row 7	9	Anode Row 1
3	Cathode Column 2	10	Cathode Column 4
4	Cathode Column 3	11	Cathode Column 3
5	Anode Row 4	12	Anode Row 4
6	Cathode Column 5	13	Cathode Column 1
7	Anode Row 6	14	Anode Row 2



Model No : CSM-57131A9/CSM-57141A9

■ Absolute Maximum Rating -

(Ta=25°C)

Parameter	Symbol	Rating	Unit
Power Dissipation Per Dice	PAD	70	mW
Continuous Forward Current Per Dice	IAF	25	mA
Peak Current Per Dice(duty cycle 1/10, 1kHz)	IPF	90	mA
Derating Linear From 25°C Per Dice	-	0.33	mA/°C
Reverse Voltage Per Dice	VR	5	V
Operating Temp.	Topr	-35 ~ +85	°C
Storage Temp.	Tstg	-35 ~ +85	°C
Solder temperature 1/16 inch below seating plane for 3 seconds at 260°C			

■ Electro-optical Characteristics -

(Ta=25°C)

Parameter	Symbol	Min.	Typ.	Max.	Unit	Condition
Forward Voltage Per Segment	VF	-	2.0	2.8	V	IF=20mA
Luminous Intensity Per Segment	Iv	-	38	-	mcd	IF=10mA
Peak Emission Wavelength	λ_p	-	610	-	nm	IF=20mA
Dominant Wavelength	λ_d	-	605	-	nm	IF=20mA
Spectrum Radiation Bandwidth	$\Delta \lambda$	-	20	-	nm	IF=20mA
Reverse Current	IR	-	-	100	μA	VR=5V
Luminous Intensity Matching Ratio	IV-m	-	-	2:1	-	Ip=80mA 1/16Duty



Model No: CSM-57131A9/CSM-57141A9

■ Typical Electrical / Optical Characteristics Curves -

(Ta = 25°C Unless Otherwise Noted)

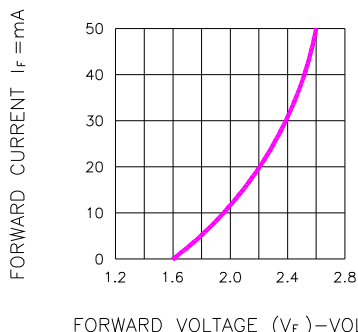

Fig.1 FORWARD CURRENT VS. FORWARD VOLTAGE

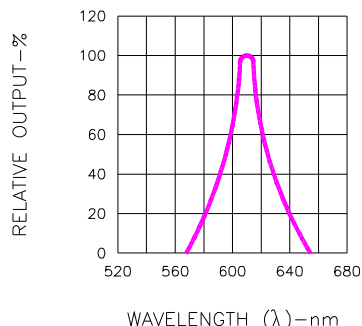

Fig.2 SPECTRAL RESPONSE

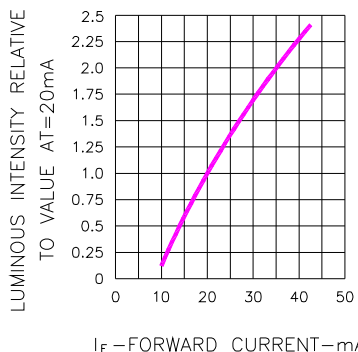

Fig.3 RELATIVE LUMINOUS INTENSITY VS. FORWARD CURRENT

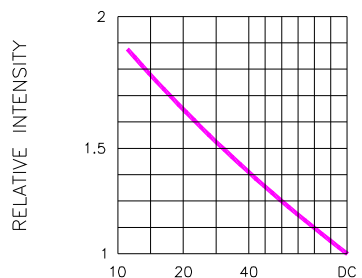

Fig.5 LUMINOUS INTENSITY VS. DUTY CYCLE
(AVERAGE I_F = 10mA)

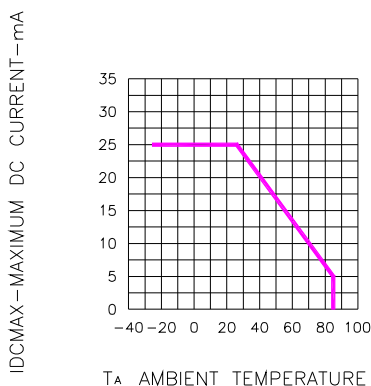

Fig.4 MAXIMUM ALLOWABLE DC CURRENT PER SEGMENT VS. A FUNCTION OF AMBIENT TEMPERATURE

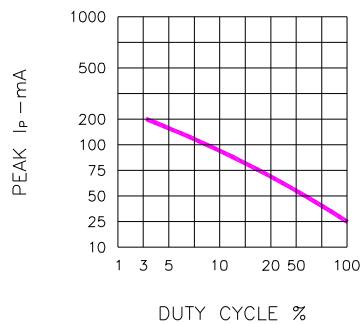

Fig.6 MAX PEAK CURRENT VS. DUTY CYCLE %
(REFRESH RATE f = 1 KHz)



Spec. No.	PS-ND-0710
Rev.	A

Model No: CSM-57131A9/CSM-57141A9

■ Package Dimensions

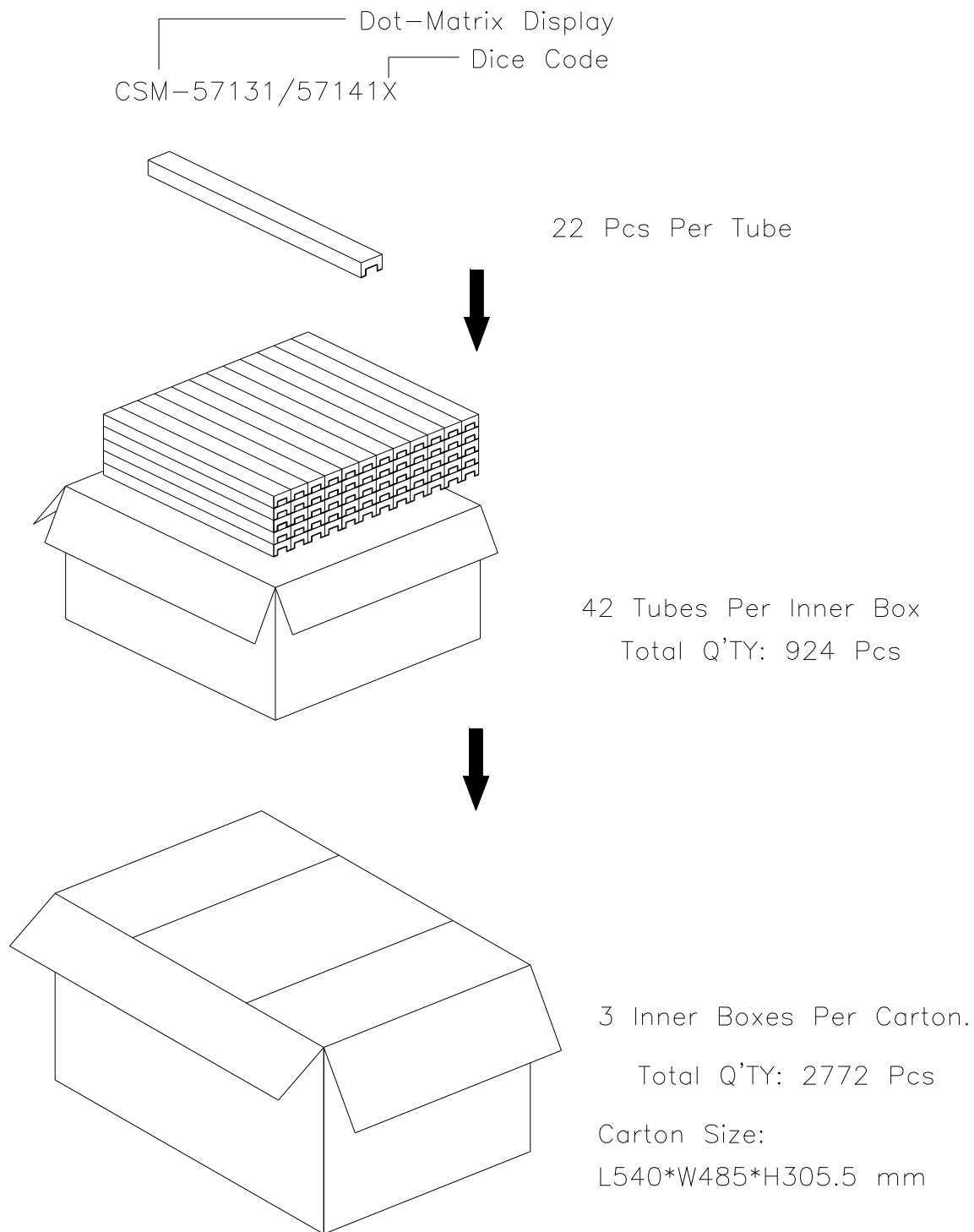

Note: The specifications are subject to change without notice. Please contact us for updated information.