

GENERAL DESCRIPTION

The CM2593/P is a monolithic integrated circuit that provide all the active functions for a step-down switching regulator, capable of driving a 2A load without additional transistor component. Requiring a minimum number of external component, the board space can be saved easily. The external shutdown function can be controlled by TTL logic level and then come into standby mode. The internal compensation makes feedback control have good line and load regulation without external design. Regarding protected function, thermal shutdown is to prevent over temperature operating from damage, and current limit is against over current operating of the output switch. The CM2593/P operates at a switching frequency of 150Khz thus allowing smaller sized filter components than what would be needed with lower frequency switching regulators. Other features include a guaranteed $\pm 4\%$ tolerance on output voltage under specified input voltage and output load conditions, and $\pm 15\%$ on the oscillator frequency. The output version included fixed 3.3V, 5V, and an adjustable type. The packages are available in a standard 8-lead SOP8.

FEATURES

- ◆ 3.3V, 5V and adjustable output versions
- ◆ Adjustable version output voltage range, 1.23V to 37V $\pm 4\%$ max over line and load condition
- ◆ SOP-8L packages
- ◆ Voltage mode non-synchronous PWM control
- ◆ Thermal-shutdown and current-limit protection
- ◆ ON/OFF shutdown control input
- ◆ Input voltage range up to 40V
- ◆ Output load current: 2A
- ◆ 150 kHz fixed frequency internal oscillator
- ◆ Low power standby mode
- ◆ Built-in switching transistor on chip

APPLICATIONS

- ◆ Simple High-efficiency step-down(buck) regulator
- ◆ Efficient pre-regulator for linear regulators
- ◆ On-card switching regulators
- ◆ Battery / Car Charger
- ◆ Positive to negative converter
- ◆ Digital Still and Video Cameras

TYPICAL APPLICATIONS

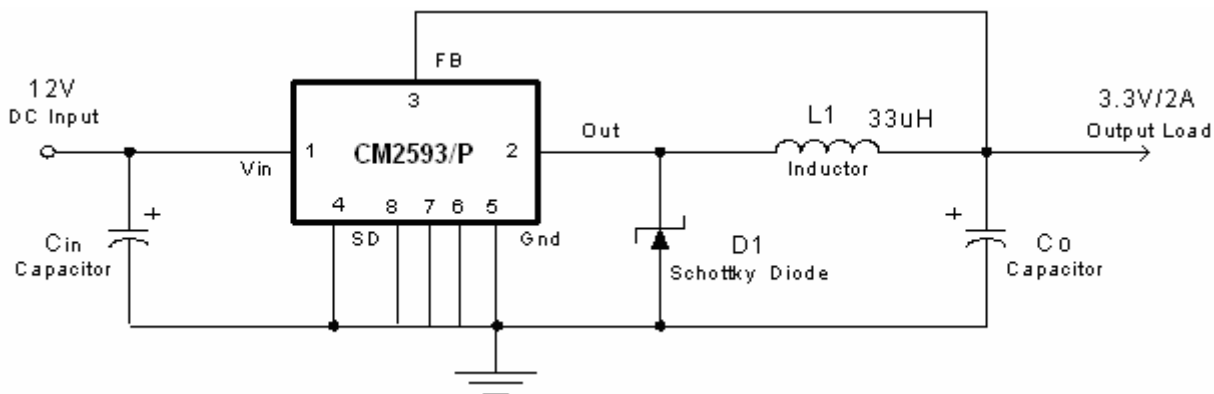
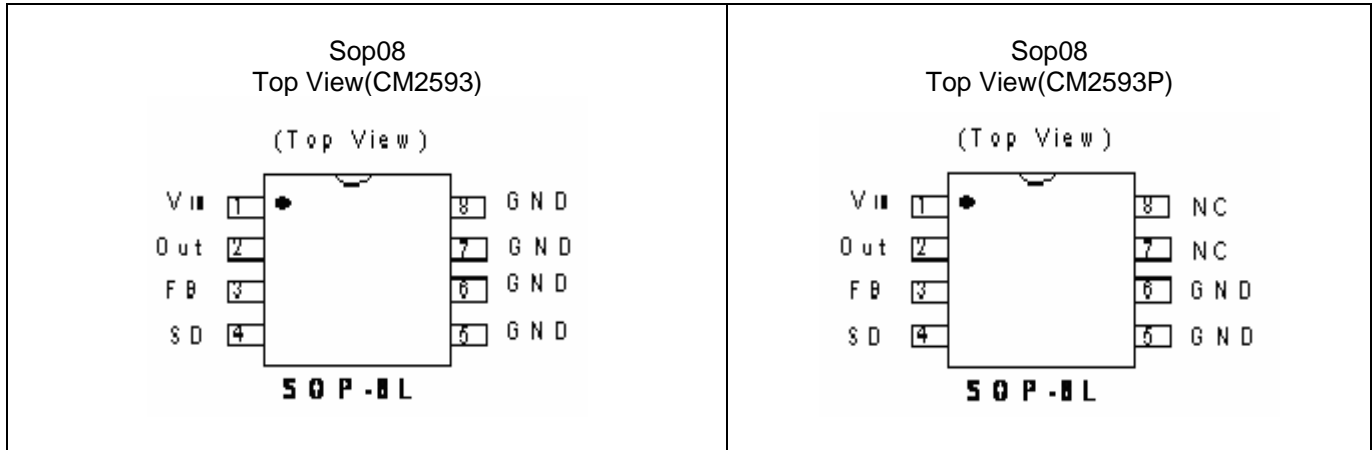
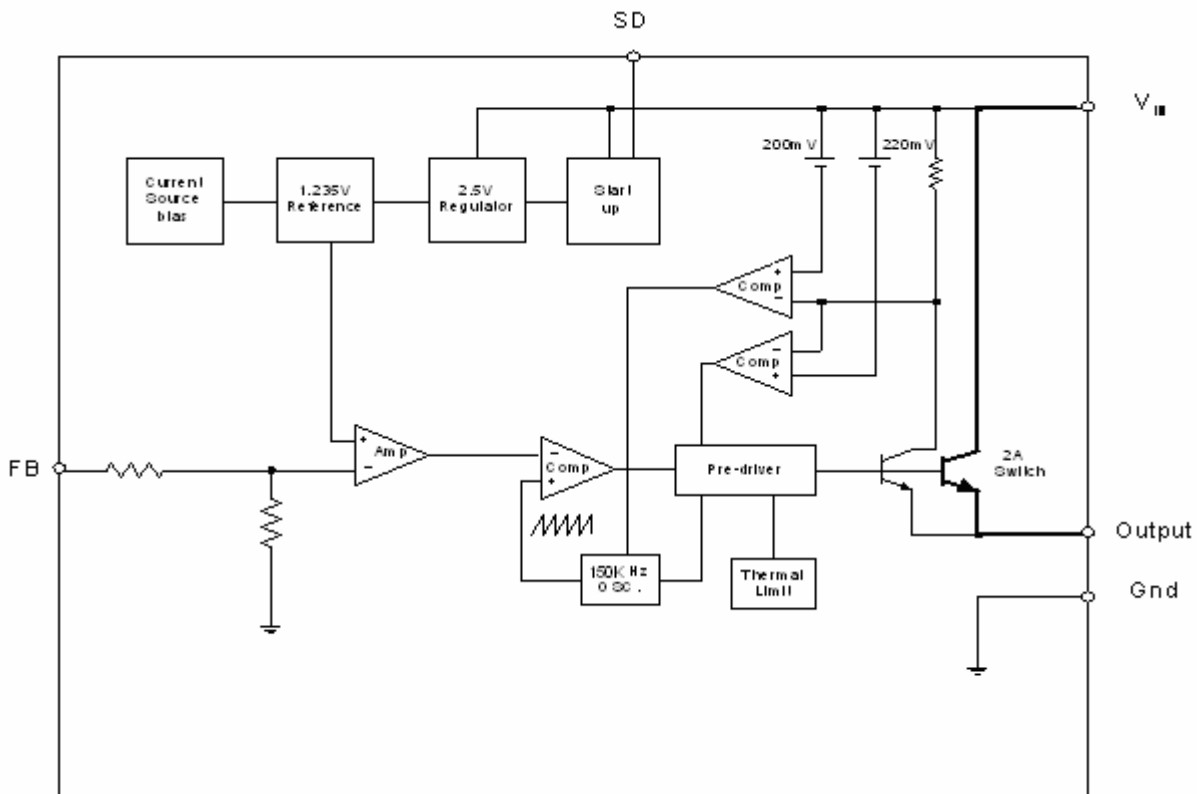

Figure 1. Basic Application Circuit with CM2593/P fixed version

PIN CONFIGURATION



BLOCK DIAGRAM



PIN DESCRIPTION

Pin No.	Symbol	Description
1	V _{IN}	Operating voltage input
2	Out	Switching output
3	FB	Output voltage feedback control
4	SD	ON/OFF Shutdown
5-8	GND	Ground Pin

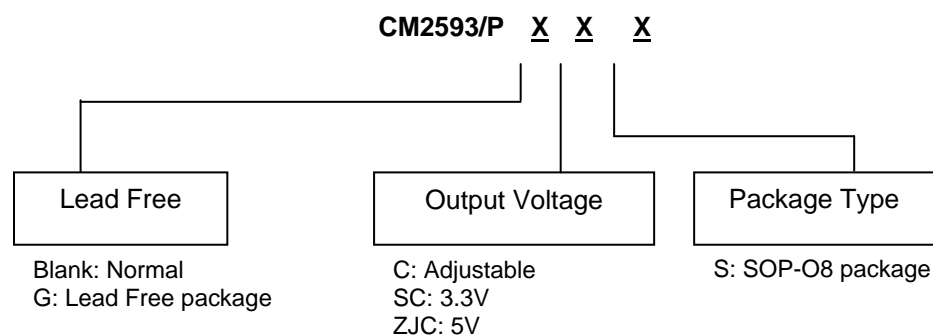
ORDERING INFORMATION

ABSOLUTE MAXIMUM RATINGS

Symbol	Parameter	Rating	Unit
V _{CC}	Supply Voltage	+45	V
V _{SD}	ON/OFF Pin input voltage	-0.3 to +25	V
V _{FB}	Feedback Pin voltage	-0.3 to +25	V
V _{OUT}	Output voltage to Ground	-1	V
P _D	Power dissipation	Internally limited	W
T _{ST}	Storage temperature	-65 to +150	°C
T _{OP}	Operating temperature	-40 to +125	°C
V _{OP}	Operating voltage	+4.5 to +45	V
θ _{Ja}	Thermal Resistance	75	°/W
θ _{Jc}	Thermal Resistance	14	°/W

■ ELECTRICAL CHARACTERISTICS(All Output Voltage Versions)

 Unless otherwise specified, $V_{IN}=12V$ for 3.3V, 5V, adjustable version and $V_{IN}=24V$ for the 12V version. $I_{LOAD} = 0.2A$

Symbol	Parameter		Conditions	Min.	Typ.	Max.	Unit
I_B	Feedback bias current		$V_{FB}=1.3V$ (Adjustable version only)		-10	-50	nA
						-100	
F_{OSC}	oscillator frequency		$T_J=25^{\circ}C$ $-40^{\circ}C \leq T_J \leq 125^{\circ}C$		127	150	Khz
						173	
F_{scp}	Oscillator frequency of short circuit protect		When current limit occurred and $V_{FB} < 0.55V$		30	60	Khz
V_{SAT}	saturation voltage		$I_{OUT}=1.5A$ no outside circuit $V_{FB}=0V$ force driver on		1.15	1.4	V
						1.5	
DC	Max. Duty Cycle(ON)		$V_{FB}=0V$ force driver on		100		%
	Min. Duty cycle(OFF)		$V_{FB}=12V$ force driver off		0		
I_{CL}	current limit		peak current no outside circuit $V_{FB}=0$ force driver on	2.4	2.8	3.3	A
						3.6	
I_L	Output = 0	Output leakage current	no outside circuit $V_{FB}=12$ force driver off			-200	uA
	Output = 1		$V_{IN}=24V$		-5		mA
I_Q	Quiescent Current		$V_{FB}=12$ force driver off		5	10	mA
I_{STBY}	Standby Quiescent Current		ON/OFF pin=5V $V_{IN}=24V$		70	150	uA
						200	
V_{IL}	ON/OFF pin logic input threshold voltage		Low (regulator ON)	-		0.6	V
V_{IH}			High (regulator OFF)	2.0	1.3	-	
I_H	ON/OFF pin logic input current		$V_{LOGIC}=2.5V$ (OFF)			-0.01	uA
I_L	ON/OFF pin input current		$V_{LOGIC}=0.5V$ (ON)		-0.1	-1	
T_S	Over temperature shutdown threshold		T_J increasing		175		$^{\circ}C$
			T_J decreasing		150		

CM2593/P

2A Step Down VOLTAGE REGULATOR

	Symbol	Parameter	Conditions	Typ.	Limit	Unit
CM2593/P-ADJ	V_{FB}	Output Feedback	$5V \leq V_{IN} \leq 40V$ $0.2A \leq I_{LOAD} \leq 2A$ V_{OUT} programmed for 3V	1.235	1.193/1.18 1.267/1.28	V V_{MIN} V_{MAX}
	η	Efficiency	$V_{IN} = 12V, I_{LOAD}=2A$	75		%
CM2593/P-3.3V	V_{OUT}	Output voltage	$5.5V \leq V_{IN} \leq 40V$ $0.2A \leq I_{LOAD} \leq 2A$	3.3	3.168/3.135 3.432/3.465	V V_{MIN} V_{MAX}
	η	Efficiency	$V_{IN} = 12V, I_{LOAD}=2A$	75		%
CM2593/P-5V	V_{OUT}	Output voltage	$8V \leq V_{IN} \leq 40V$ $0.2A \leq I_{LOAD} \leq 2A$	5	4.8/4.75 5.2/5.25	V V_{MIN} V_{MAX}
	η	Efficiency	$V_{IN} = 12V, I_{LOAD}=2A$	80		%

Specifications with boldface type are for full operating temperature range, the other type are for $T_J=25^\circ C$.

FUNCTIONAL DESCRIPTION

Pin Functions

+V_{IN}

This is the positive input supply for the IC switching regulator. A suitable input bypass capacitor must be present at this pin to minimize voltage transients and to supply the switching currents needed by the regulator.

Out

Internal switch and power output. The voltage at this pin switches between $(+V_{IN} - V_{SAT})$ and approximately $-0.5V$, with a duty cycle of approximately V_{OUT} / V_{IN} . The PC board copper area connected to this pin should be kept a minimum in order to reduce the coupling sensitivity to the circuitry

Ground

Circuit ground.

Feedback

Complete the feedback loop by sensing the regulated output voltage

$\overline{\text{ON/OFF}}$

Allows the switching regulator circuit to be shutdown using logic level signals thus dropping the total input supply current to approximately 100uA. Pulling this pin below a threshold voltage of approximately 1.3V turns the regulator on, and pulling this pin above 1.3V (up to a maximum of 25V) shuts the regulator down. If this shutdown feature is not needed, the $\overline{\text{ON/OFF}}$ pin can be wired to the ground pin or it can be left open, in either case the regulator will be in the ON condition.

Thermal Considerations

The SOP-8 package needs a heat sink under most conditions. The size of the heat-sink depends on the input voltage, the output voltage, the load current and the ambient temperature. The CM2593/P junction temperature rises above ambient temperature for a 2A load and different input and output voltages. The data for these curves was taken with the CM2593/P (SOP-8 package) operating as a buck switching regulator in an ambient temperature of 25°C (still air). These temperature increments are all approximate and are affected by many factors. Some of these factors include board size, shape, thickness, position, location, and even board temperature. Other factors are trace width, total printed circuit copper area, copper thickness, single or double-sided, multi-layer board and amount of solder on the board. Higher ambient temperatures require more heat sinking.

For the best thermal performance, wide copper traces and generous amounts of printed circuit board copper should be used in the board layout. (One exception is the out(switch) pin, which should not have large areas of copper.) Large areas of copper provide the best transfer of heat (lower thermal resistance) to the surrounding air, and moving air lowers the thermal resistance even further.

The effectiveness of the PC board to dissipate heat also depends on the size, quantity and spacing of other components on the board, as well as whether the surrounding air is still or moving. Furthermore, some of these components such as the catch diode will add heat to the PC board and heat can vary as the input voltage changes. For the inductor, depending on the physical size, type of core material and the DC resistance, it could either act as a heat sink taking heat away from the board, or it could add heat to the board.

APPLICATIONS CIRCUIT

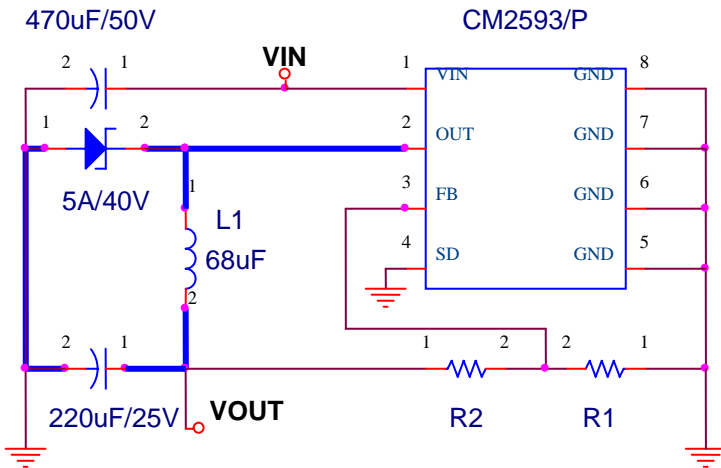

Output Voltage Fixed : $R1=NC$, $R2=0$
 Output Voltage Adj : $V_o = V_{ref} * (1 + (R2/R1))$
 $V_{fb} = 1.235V$; $R1 = 1K \sim 5K$

APPLICATIONS Demo Board Layout

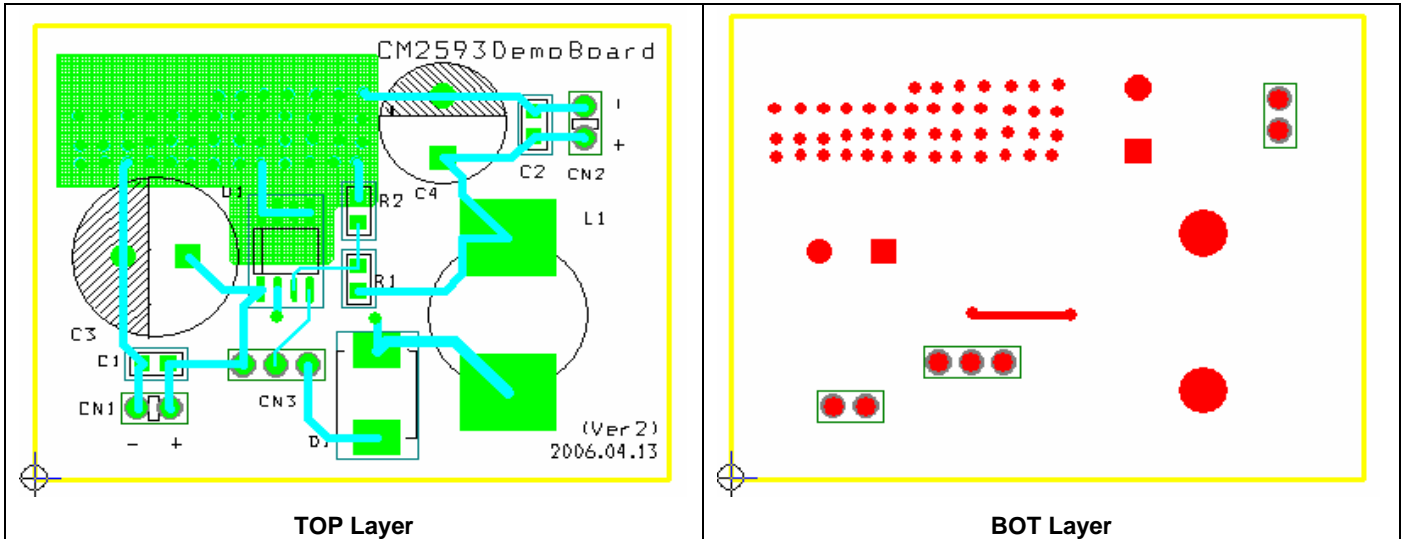

Notice :

1. R1/R2 must be close to Pin3 (VFB), but keep feedback wiring away from inductor.
2. Inductor/diode must be close to Pin2 (Vout), heavy lines must be keep short and thick .
3. Please to refer to Circuit and Demo Board Layout (the Fig. as above)

DIFFERENT HEATSINK AREA

Thermal Resistance vs. Different Cooper Area Layout Design

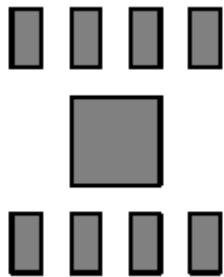
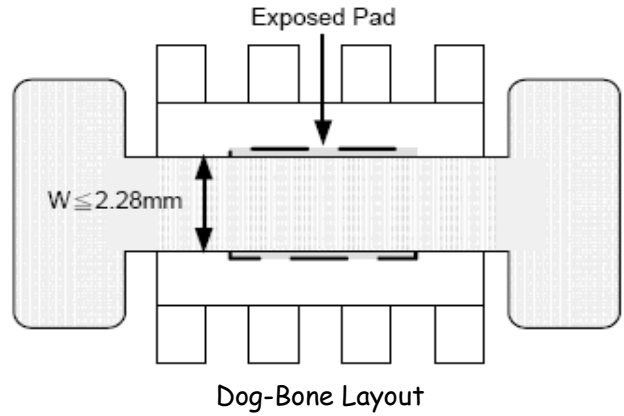
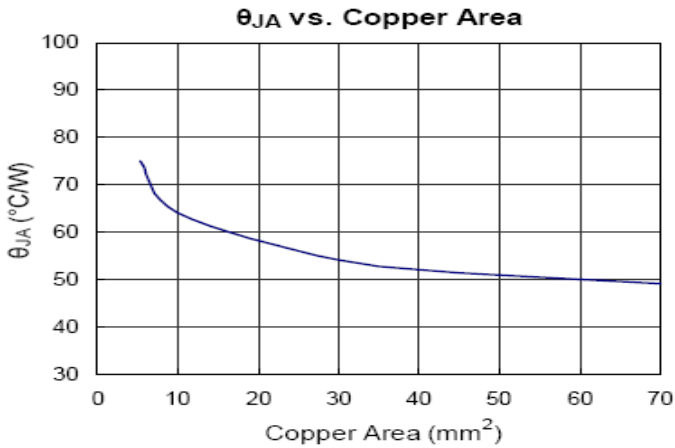

Minimum Footprint , $\theta_{JA} = 75^{\circ}\text{C}/\text{W}$

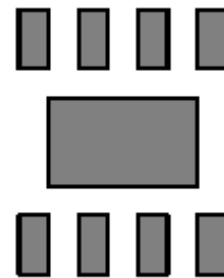

Copper Area = 10mm^2 , $\theta_{JA} = 64^{\circ}\text{C}/\text{W}$

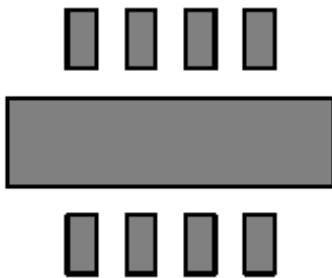

Copper Area = 30mm^2 , $\theta_{JA} = 54^{\circ}\text{C}/\text{W}$

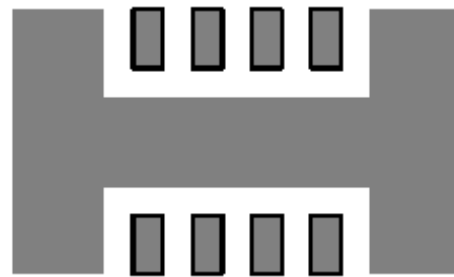

Copper Area = 50mm^2 , $\theta_{JA} = 51^{\circ}\text{C}/\text{W}$

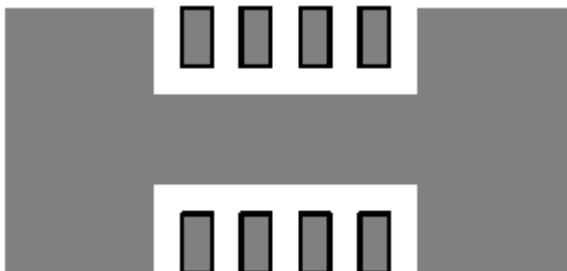

Copper Area = 70mm^2 , $\theta_{JA} = 49^{\circ}\text{C}/\text{W}$

Typical Performance Characteristics

(Test Figure 1 above unless otherwise specified)

Typical Performance Characteristics
Normalized Output Voltage

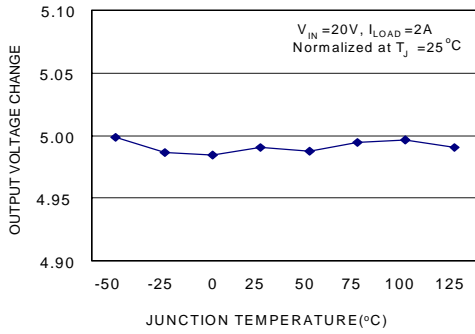

Efficiency

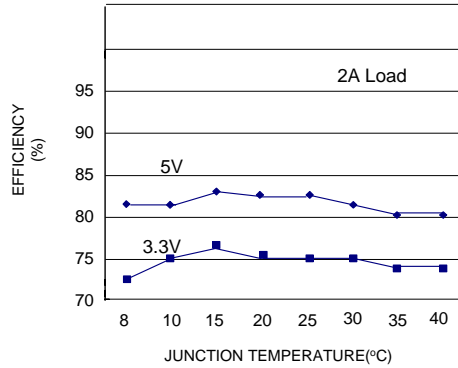

Switch Saturation Voltage

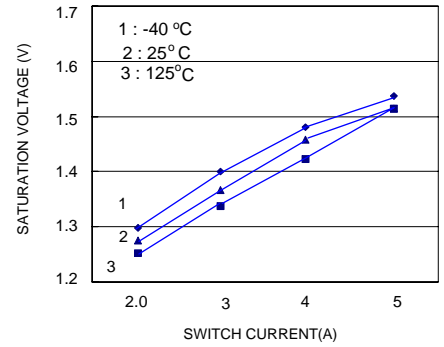

Switch Current Limit

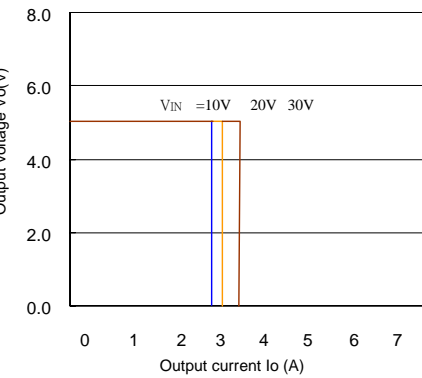

Operating Quiescent Current

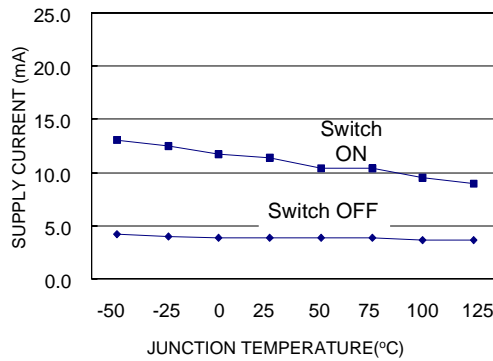

Shutdown Quiescent Current

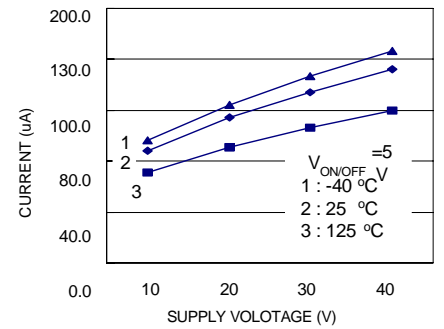

Minimum Operating Supply Voltage

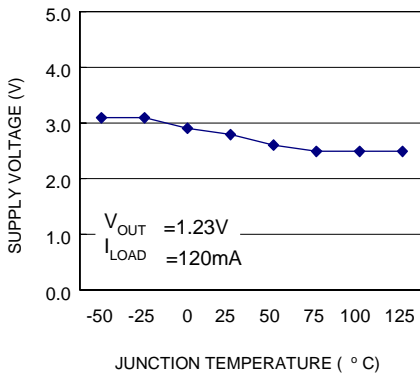

ON/OFF Threshold Voltage

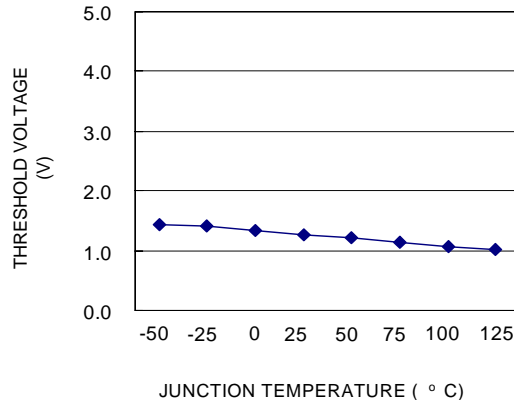

ON/OFF Pin Current (Sinking)

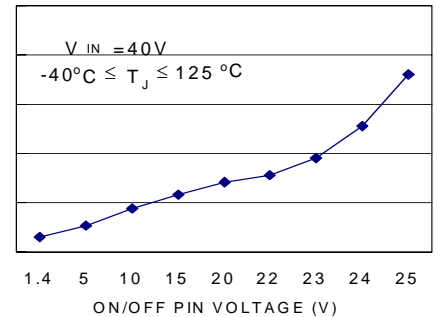

CM2593/P

2A Step Down VOLTAGE REGULATOR

Switch Frequency

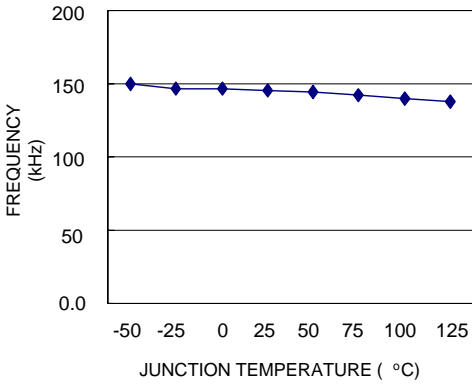

Feedback Pin Bias Current

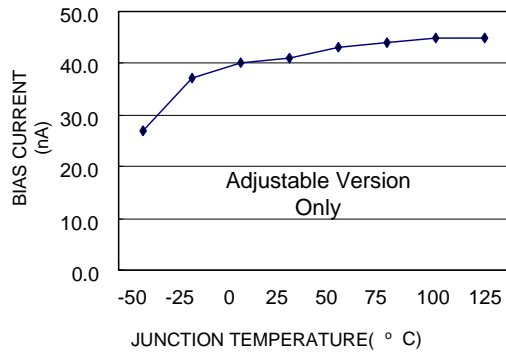

Thermal protection

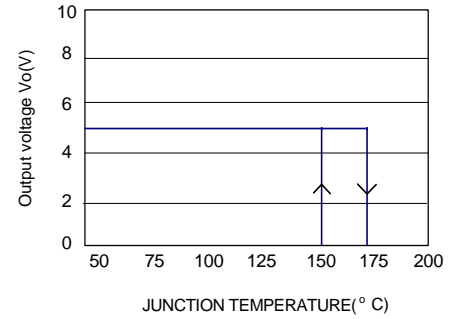

Light Load operation

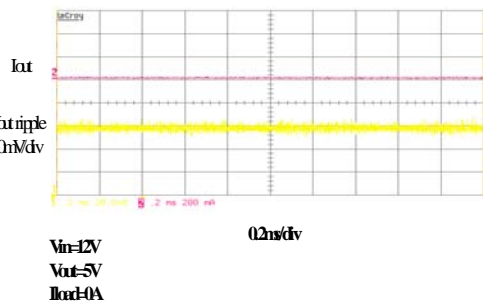

Heavy Load operation

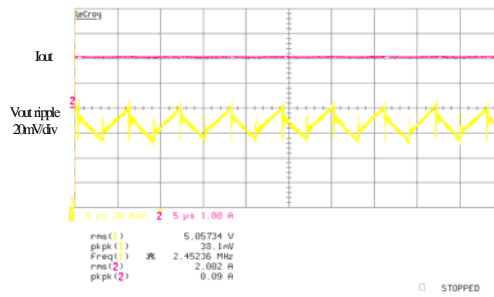

Load step

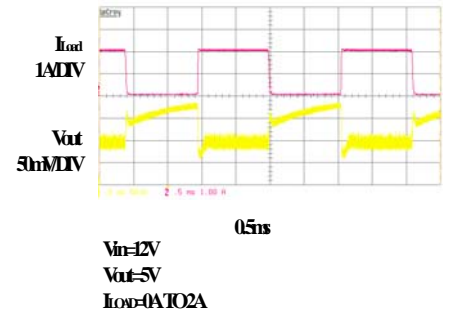

PACKAGE DIMENSION

8-PIN SOP (S08)

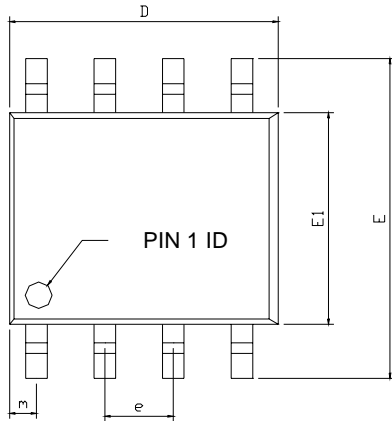

SYMBOLS	DIMENSIONS IN MILLIMETERS			DIMENSIONS IN INCHS		
	MIN	NOM	MAX	MIN	NOM	MAX
A1	0.10	---	0.25	0.004	---	0.010
A2	1.40	---	1.55	0.055	---	0.061
b	0.30	---	0.51	0.012	---	0.020
C	0.15	---	0.26	0.006	---	0.010
D	4.60	---	5.06	0.169	---	0.199
E	5.79	---	6.20	0.228	---	0.244
E1	3.76	---	4.01	0.148	---	0.158
e	---	1.27	---	---	0.050	---
L	0.38	---	0.69	0.015	---	0.035
m	0.43	---	0.69	0.017	---	0.027
θ	0°	---	8°	0°	---	8°

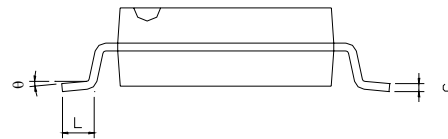
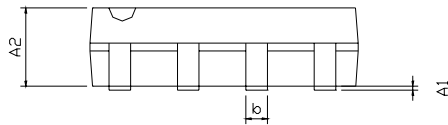

8-Pin SOP w/ Power Pad (PS08)

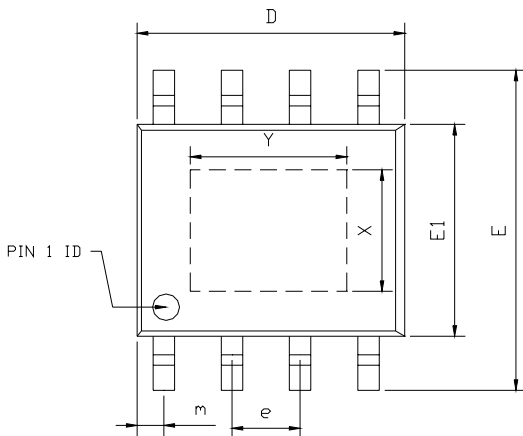

SYMBOLS	DIMENSIONS IN MILLIMETERS			DIMENSIONS IN INCHS		
	MIN	NOM	MAX	MIN	NOM	MAX
A1	0.10	---	0.25	0.004	---	0.010
A2	1.40	---	1.55	0.055	---	0.061
b	0.30	---	0.51	0.012	---	0.020
C	0.15	---	0.26	0.006	---	0.010
D	4.60	---	5.06	0.169	---	0.199
E	5.79	---	6.20	0.228	---	0.244
E1	3.76	---	4.01	0.148	---	0.158
e	---	1.27	---	---	0.050	---
L	0.38	---	0.69	0.015	---	0.035
m	0.43	---	0.69	0.017	---	0.027
θ	0°	---	8°	0°	---	8°

EXPOSED PAD DIMENSION : (mm)
PAD SIZE: X=2.34 ; Y=2.92

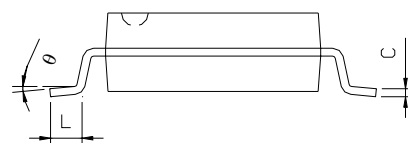
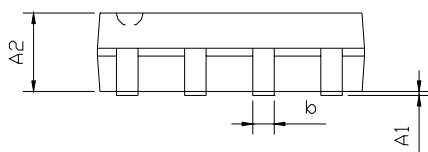

IMPORTNT NOTICE

Champion Microelectronic Corporation (CMC) reserves the right to make changes to its products or to discontinue any integrated circuit product or service without notice, and advises its customers to obtain the latest version of relevant information to verify, before placing orders, that the information being relied on is current.

A few applications using integrated circuit products may involve potential risks of death, personal injury, or severe property or environmental damage. CMC integrated circuit products are not designed, intended, authorized, or warranted to be suitable for use in life-support applications, devices or systems or other critical applications. Use of CMC products in such applications is understood to be fully at the risk of the customer. In order to minimize risks associated with the customer's applications, the customer should provide adequate design and operating safeguards.

HsinChu Headquarter

5F, No. 11, Park Avenue II,
Science-Based Industrial Park,
HsinChu City, Taiwan 300

TEL: +886-3-567 9979

FAX: +886-3-567 9909

<http://www.champion-micro.com>

Sales & Marketing

7F-6, No.32, Sec. 1, Chenggong Rd.,
Nangang District, Taipei City 115,
Taiwan R.O.C.

TEL: +886-2-2788 0558

FAX: +886-2-2788 2985