

PLEASE CHECK WWW.MOLEX.COM FOR LATEST PART INFORMATION

Part Number: [0026202152](#)
Status: **Active**
Overview: [kk](#)
Description: 3.96mm (.156") Pitch KK® Wire-to-Board Header, Vertical Round Pin, 15 Circuits, Tin (Sn) Plating, with Mating Pin Length of 16.18mm (.637")

Documents:

[3D Model](#) [Product Specification PS-99020-0087 \(PDF\)](#)
[Drawing \(PDF\)](#) [RoHS Certificate of Compliance \(PDF\)](#)

Agency Certification

UL E29179

General

Product Family PCB Headers
 Series [3192](#)
 Application Board-to-Board, Wire-to-Board
 Overview [kk](#)
 Product Name KK®

Physical

Breakaway No
 Circuits (Loaded) 15
 Circuits (maximum) 15
 Color - Resin Natural
 Durability (mating cycles max) 25
 First Mate / Last Break No
 Flammability 94V-2
 Glow-Wire Compliant No
 Guide to Mating Part No
 Keying to Mating Part None
 Lock to Mating Part None
 Material - Metal Brass
 Material - Plating Mating Tin
 Material - Plating Termination Tin
 Material - Resin Nylon
 Number of Rows 1
 Orientation Vertical
 PC Tail Length (in) 0.175 In
 PC Tail Length (mm) 4.45 mm
 PCB Locator No
 PCB Retention None
 PCB Thickness Recommended (in) 0.062 In
 PCB Thickness Recommended (mm) 1.60 mm
 Packaging Type Bag
 Pitch - Mating Interface (in) 0.156 In
 Pitch - Mating Interface (mm) 3.96 mm
 Plating min: Mating (µin) 200
 Plating min: Mating (µm) 5
 Plating min: Termination (µin) 200
 Plating min: Termination (µm) 5
 Polarized to Mating Part No
 Polarized to PCB No
 Shrouded No
 Stackable Yes
 Temperature Range - Operating 0°C to +75°C



EU RoHS

ELV and RoHS Compliant
REACH SVHC
 Not Reviewed
Halogen-Free Status
Not Reviewed

China RoHS



Need more information on product environmental compliance?

Email productcompliance@molex.com
 For a multiple part number RoHS Certificate of Compliance, [click here](#)

Please visit the [Contact Us](#) section for any non-product compliance questions.

Search Parts in this Series

[3192Series](#)

Mates With

[3069](#) KK® Crimp Terminal Housing. [3215](#) KK® PC Board Connector

Termination Interface: Style Through Hole

Electrical

Current - Maximum per Contact 7A
Voltage - Maximum 250V

Material Info

Old Part Number 319215B

Reference - Drawing Numbers

Product Specification PS-99020-0087
Sales Drawing SDAE-3192-N*

This document was generated on 05/26/2010

PLEASE CHECK WWW.MOLEX.COM FOR LATEST PART INFORMATION

ENG No:	AE-3192-NA	AE-3192-NB	AE-3192-NC	AE-3192-ND	AE-3192-NE	AE-3192-NF	AE-3192-NH	AE-3192-NI	AE-3192-NJ	AE-3192-NK	AE-3192-NM	AE-3192-NP	AEX-3192-NR	AE-3192-NS	AE-3192-NW	AEX-3192-NY	AE-3192-NZ
DIM "D"	(11.43) .450	(16.18) .637	(22.53) .887	(27.30) 1.075	(14.27) .562	(32.51) 1.280	(12.33) .485	(14.27) .562	(20.95) .825	(17.47) .688	(12.70) .500	(19.05) .750	(11.43) .450	(20.32) .800	(3.00) .118	(11.43) .450	(27.31) 1.075
DIM "C"	(19.05) .750	(23.80) .937	(30.15) 1.187	(34.92) 1.375	(23.80) .937	(39.67) 1.562	(19.05) .750	(20.32) .800	(28.57) 1.125	(25.40) 1.000	(28.87) 1.125	(39.67) 1.562	(31.75) 1.250	(28.58) 1.125	(19.05) .750	(25.40) 1.000	(34.93) 1.375

CCT SIZE	DIM "A"	DIM "B"	PART No	PART No	PART No	PART No	PART No	PART No	PART No	PART No	PART No	PART No	PART No	PART No	PART No	PART No	PART No	PART No	
2	(3.96) .156	(7.92) .312	26-20-2021	26-20-2022	26-20-2023	26-20-2024	26-20-2025	26-20-2026	26-20-2027	26-20-2028	26-20-2029	26-21-2021	26-21-2022	26-21-2023	NOT TOOLED	26-21-2024	38-00-5822	NOT TOOLED	38-00-4072
3	(7.92) .312	(11.89) .468	26-20-2031	26-20-2032	26-20-2033	26-20-2034	26-20-2035	26-20-2036	26-20-2037	26-20-2038	26-20-2039	26-21-2031	26-21-2032	26-21-2033	↑	26-21-2034	38-00-5823	↑	38-00-4073
4	(11.89) .468	(15.85) .624	26-20-2041	26-20-2042	26-20-2043	26-20-2044	26-20-2045	26-20-2046	26-20-2047	26-20-2048	26-20-2049	26-21-2041	26-21-2042	26-21-2043		26-21-2044	38-00-5824		38-00-4074
5	(15.85) .624	(19.81) .780	26-20-2051	26-20-2052	26-20-2053	26-20-2054	26-20-2055	26-20-2056	26-20-2057	26-20-2058	26-20-2059	26-21-2051	26-21-2052	26-21-2053		26-21-2054	38-00-5825		38-00-4075
6	(19.81) .780	(23.77) .936	26-20-2061	26-20-2062	26-20-2063	26-20-2064	26-20-2065	26-20-2066	26-20-2067	26-20-2068	26-20-2069	26-21-2061	26-21-2062	26-21-2063		26-21-2064	38-00-5826		38-00-4076
7	(23.77) .936	(27.74) 1.092	26-20-2071	26-20-2072	26-20-2073	26-20-2074	26-20-2075	26-20-2076	26-20-2077	26-20-2078	26-20-2079	26-21-2071	26-21-2072	26-21-2073		26-21-2074	38-00-5827		38-00-4077
8	(27.74) 1.092	(31.70) 1.248	26-20-2081	26-20-2082	26-20-2083	26-20-2084	26-20-2085	26-20-2086	26-20-2087	26-20-2088	26-20-2089	26-21-2081	26-21-2082	26-21-2083		26-21-2084	38-00-5828		38-00-4078
9	(31.70) 1.248	(35.66) 1.404	26-20-2091	26-20-2092	26-20-2093	26-20-2094	26-20-2095	26-20-2096	26-20-2097	26-20-2098	26-20-2099	26-21-2091	26-21-2092	26-21-2093		26-21-2094	38-00-5829		38-00-4079
10	(35.66) 1.404	(39.62) 1.560	26-20-2101	26-20-2102	26-20-2103	26-20-2104	26-20-2105	26-20-2106	26-20-2107	26-20-2108	26-20-2109	26-21-2101	26-21-2102	26-21-2103		26-21-2104	38-00-5830		38-00-4080
11	(39.62) 1.560	(43.59) 1.716	26-20-2111	26-20-2112	26-20-2113	26-20-2114	26-20-2115	26-20-2116	26-20-2117	26-20-2118	26-20-2119	26-21-2111	26-21-2112	26-21-2113		26-21-2114	38-00-5831		38-00-4081
12	(43.59) 1.716	(47.55) 1.872	26-20-2121	26-20-2122	26-20-2123	26-20-2124	26-20-2125	26-20-2126	26-20-2127	26-20-2128	26-20-2129	26-21-2121	26-21-2122	26-21-2123		26-21-2124	38-00-5832		38-00-4082
13	(47.55) 1.872	(51.51) 2.028	26-20-2131	26-20-2132	26-20-2133	26-20-2134	26-20-2135	26-20-2136	26-20-2137	26-20-2138	26-20-2139	26-21-2131	26-21-2132	26-21-2133		26-21-2134	38-00-5833		38-00-4083
14	(51.51) 2.028	(55.47) 2.184	26-20-2141	26-20-2142	26-20-2143	26-20-2144	26-20-2145	26-20-2146	26-20-2147	26-20-2148	26-20-2149	26-21-2141	26-21-2142	26-21-2143		26-21-2144	38-00-5834		38-00-4084
15	(55.47) 2.184	(59.44) 2.340	26-20-2151	26-20-2152	26-20-2153	26-20-2154	26-20-2155	26-20-2156	26-20-2157	26-20-2158	26-20-2159	26-21-2151	26-21-2152	26-21-2153		26-21-2154	38-00-5835		38-00-4085
16	(59.44) 2.340	(63.40) 2.496	26-20-2161	26-20-2162	26-20-2163	26-20-2164	26-20-2165	26-20-2166	26-20-2167	26-20-2168	26-20-2169	26-21-2161	26-21-2162	26-21-2163		26-21-2164	38-00-5836		38-00-4086
17	(63.40) 2.496	(67.36) 2.652	26-20-2171	26-20-2172	26-20-2173	26-20-2174	26-20-2175	26-20-2176	26-20-2177	26-20-2178	26-20-2179	26-21-2171	26-21-2172	26-21-2173		26-21-2174	38-00-5837		38-00-4087
18	(67.36) 2.652	(71.32) 2.808	26-20-2181	26-20-2182	26-20-2183	26-20-2184	26-20-2185	26-20-2186	26-20-2187	26-20-2188	26-20-2189	26-21-2181	26-21-2182	26-21-2183		26-21-2184	38-00-5838		38-00-4088
19	(71.32) 2.808	(75.29) 2.964	26-20-2191	26-20-2192	26-20-2193	26-20-2194	26-20-2195	26-20-2196	26-20-2197	26-20-2198	26-20-2199	26-21-2191	26-21-2192	26-21-2193		26-21-2194	38-00-5839	↓	38-00-4089
20	(75.29) 2.964	(79.25) 3.120	26-20-2201	26-20-2202	26-20-2203	26-20-2204	26-20-2205	26-20-2206	26-20-2207	26-20-2208	26-20-2209	26-21-2201	26-21-2202	26-21-2203	NOT TOOLED	26-21-2204	38-00-5840	NOT TOOLED	38-00-4090

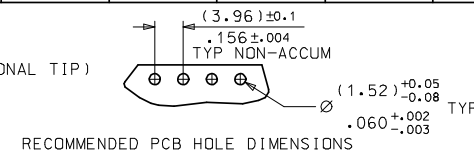
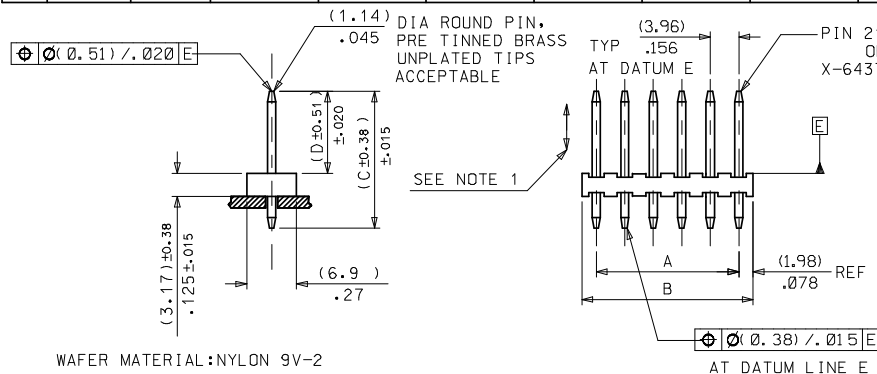

- NOTES:
- PIN PUSH OUT FORCE 3 LBS MIN
 - PIN MUST CONFORM TO MOLEX SOLDERABILITY SPEC No 152 AFTER PLATING
 - RECOMMENDED PCB THICKNESS 1.6MM

ADDED NOTE 3 EC NO: E2008-0424 DRAWN: K I ERMAN 2008/03/18 CHKD: B MAGUIRE 2008/03/20 APPR: B MAGUIRE 2008/03/20	QUALITY SYMBOLS ▽=0 ▽=0	GENERAL TOLERANCES (UNLESS SPECIFIED) mm INCH 4 PLACES ± --- ± --- 3 PLACES ± --- ± .010 2 PLACES ± 0.25 ± .014 1 PLACE ± 0.35 ± --- ANGULAR ± 1/2°	DIMENSION STYLE MM ONLY DRAWN BY DATE T. MAHON 98/10/02 CHECKED BY DATE M. GOONEY 98/10/09 APPROVED BY DATE MWILHITE 98/10/09	SCALE --- DESIGN UNITS METRIC THIRD ANGLE PROJECTION	TITLE WAFER FLAT MOLDED KK .156 .045 DIAMETER PINS
		DRAFT WHERE APPLICABLE MUST REMAIN WITHIN DIMENSIONS	MATERIAL NO. SEE CHART SIZE A2	MOLEX INCORPORATED DOCUMENT NO. SDAE-3192-N* SHEET NO. 1 OF 00	

THIS DRAWING CONTAINS INFORMATION THAT IS PROPRIETARY TO MOLEX INCORPORATED AND SHOULD NOT BE USED WITHOUT WRITTEN PERMISSION