

RF Power Field Effect Transistors

N-Channel Enhancement-Mode Lateral MOSFETs

Designed for WiMAX base station applications with frequencies up to 3800 MHz. Suitable for WiMAX, WiBro, BWA, and OFDM multicarrier Class AB and Class C amplifier applications.

- Typical WiMAX Performance: $V_{DD} = 30$ Volts, $I_{DQ} = 450$ mA, $P_{out} = 8$ Watts Avg., $f = 3400$ - 3600 MHz, 802.16d, 64 QAM $^{3/4}$, 4 bursts, 7 MHz Channel Bandwidth, Input Signal PAR = 9.5 dB @ 0.01% Probability on CCDF.
Power Gain — 14 dB
Drain Efficiency — 15.6%
Device Output Signal PAR — 8.4 dB @ 0.01% Probability on CCDF
ACPR @ 5.25 MHz Offset — -49 dBc in 0.5 MHz Channel Bandwidth
- Capable of Handling 10:1 VSWR, @ 32 Vdc, 3500 MHz, 40 Watts CW Peak Tuned Output Power
- P_{out} @ 1 dB Compression Point ≥ 40 Watts CW

Features

- Characterized with Series Equivalent Large-Signal Impedance Parameters
- Internally Matched for Ease of Use
- Integrated ESD Protection
- Greater Negative Gate-Source Voltage Range for Improved Class C Operation
- RoHS Compliant
- In Tape and Reel. R3 Suffix = 250 Units per 32 mm, 13 inch Reel.

MRF7S38040HR3
MRF7S38040HSR3

3400-3600 MHz, 8 W AVG., 30 V
WiMAX
LATERAL N-CHANNEL
RF POWER MOSFETs

CASE 465I-02, STYLE 1
NI-400-240
MRF7S38040HR3

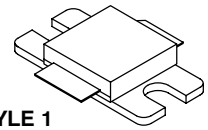

CASE 465J-02, STYLE 1
NI-400S-240
MRF7S38040HSR3

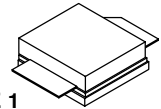

Table 1. Maximum Ratings

Rating	Symbol	Value	Unit
Drain-Source Voltage	V_{DS}	-0.5, +65	Vdc
Gate-Source Voltage	V_{GS}	-6.0, +10	Vdc
Operating Voltage	V_{DD}	32, +0	Vdc
Storage Temperature Range	T_{stg}	-65 to +150	°C
Case Operating Temperature	T_C	150	°C
Operating Junction Temperature (1,2)	T_J	225	°C

Table 2. Thermal Characteristics

Characteristic	Symbol	Value (2,3)	Unit
Thermal Resistance, Junction to Case Case Temperature 96°C, 39 W CW Case Temperature 75°C, 8 W CW	$R_{\theta JC}$	0.78 0.83	°C/W

1. Continuous use at maximum temperature will affect MTTF.
2. MTTF calculator available at <http://www.freescale.com/rf>. Select Tools/Software/Application Software/Calculators to access the MTTF calculators by product.
3. Refer to AN1955, *Thermal Measurement Methodology of RF Power Amplifiers*. Go to <http://www.freescale.com/rf>. Select Documentation/Application Notes - AN1955.

Table 3. ESD Protection Characteristics

Test Methodology	Class
Human Body Model (per JESD22-A114)	1C (Minimum)
Machine Model (per EIA/JESD22-A115)	A (Minimum)
Charge Device Model (per JESD22-C101)	IV (Minimum)

Table 4. Electrical Characteristics ($T_C = 25^\circ\text{C}$ unless otherwise noted)

Characteristic	Symbol	Min	Typ	Max	Unit
----------------	--------	-----	-----	-----	------

Off Characteristics

Zero Gate Voltage Drain Leakage Current ($V_{DS} = 65\text{ Vdc}$, $V_{GS} = 0\text{ Vdc}$)	I_{DSS}	—	—	10	μAdc
Zero Gate Voltage Drain Leakage Current ($V_{DS} = 28\text{ Vdc}$, $V_{GS} = 0\text{ Vdc}$)	I_{DSS}	—	—	1	μAdc
Gate-Source Leakage Current ($V_{GS} = 5\text{ Vdc}$, $V_{DS} = 0\text{ Vdc}$)	I_{GSS}	—	—	1	μAdc

On Characteristics

Gate Threshold Voltage ($V_{DS} = 10\text{ Vdc}$, $I_D = 124\ \mu\text{Adc}$)	$V_{GS(th)}$	1.2	2	2.7	Vdc
Gate Quiescent Voltage ($V_{DD} = 28\text{ Vdc}$, $I_D = 450\text{ mAdc}$, Measured in Functional Test)	$V_{GS(Q)}$	2	2.7	3.5	Vdc
Drain-Source On-Voltage ($V_{GS} = 10\text{ Vdc}$, $I_D = 1.15\text{ Adc}$)	$V_{DS(on)}$	0.1	0.21	0.3	Vdc

Dynamic Characteristics (1)

Reverse Transfer Capacitance ($V_{DS} = 28\text{ Vdc} \pm 30\text{ mV(rms)ac}$ @ 1 MHz, $V_{GS} = 0\text{ Vdc}$)	C_{rss}	—	0.4	—	pF
Output Capacitance ($V_{DS} = 28\text{ Vdc} \pm 30\text{ mV(rms)ac}$ @ 1 MHz, $V_{GS} = 0\text{ Vdc}$)	C_{oss}	—	229	—	pF
Input Capacitance ($V_{DS} = 28\text{ Vdc}$, $V_{GS} = 0\text{ Vdc} \pm 30\text{ mV(rms)ac}$ @ 1 MHz)	C_{iss}	—	268	—	pF

Functional Tests (In Freescale Test Fixture, 50 ohm system) $V_{DD} = 30\text{ Vdc}$, $I_{DQ} = 450\text{ mA}$, $P_{out} = 8\text{ W Avg.}$, $f = 3400\text{ MHz}$ and $f = 3600\text{ MHz}$, WiMAX Signal, 802.16d, 7 MHz Channel Bandwidth, 64 QAM $^{3/4}$, 4 Bursts, PAR = 9.5 dB @ 0.01% Probability on CCDF. ACPR measured in 0.5 MHz Channel Bandwidth @ $\pm 5.25\text{ MHz}$ Offset.

Power Gain	G_{ps}	12	14	16	dB
Drain Efficiency	η_D	14	15.6	24	%
Output Peak-to-Average Ratio @ 0.01% Probability on CCDF	PAR	7.3	8.4	—	dB
Adjacent Channel Power Ratio	ACPR	—	-49	-46	dBc
Input Return Loss	IRL	—	-10	-5	dB

1. Part internally matched both on input and output.

(continued)

Table 4. Electrical Characteristics ($T_C = 25^\circ\text{C}$ unless otherwise noted) (continued)

Characteristic	Symbol	Min	Typ	Max	Unit
Typical Performances OFDM Signal (In Freescale Test Fixture, 50 ohm system) $V_{DD} = 30\text{ Vdc}$, $I_{DQ} = 450\text{ mA}$, $P_{out} = 8\text{ W Avg.}$, $f = 3400\text{ MHz}$ and $f = 3600\text{ MHz}$, WiMAX Signal, OFDM Single-Carrier, 7 MHz Channel Bandwidth, 64 QAM $3/4$, 4 Bursts, PAR = 9.5 dB @ 0.01% Probability on CCDF.					
Mask System Type G @ $P_{out} = 8\text{ W Avg.}$ Point B at 3.5 MHz Offset Point C at 5 MHz Offset Point D at 7.4 MHz Offset Point E at 14 MHz Offset Point F at 17.5 MHz Offset	Mask	—	-27 -38 -42 -60 -60	—	dBc
Relative Constellation Error @ $P_{out} = 8\text{ W Avg.}$ (1)	RCE	—	-34	—	dB
Error Vector Magnitude (1) (Typical EVM Performance @ $P_{out} = 8\text{ W Avg.}$ with OFDM 802.16d Signal Call)	EVM	—	2.0	—	% rms

Typical Performances (In Freescale Test Fixture, 50 ohm system) $V_{DD} = 30\text{ Vdc}$, $I_{DQ} = 450\text{ mA}$, 3400-3600 MHz Bandwidth

Video Bandwidth @ 44 W PEP P_{out} where $IM3 = -30\text{ dBc}$ (Tone Spacing from 100 kHz to VBW) $\Delta IMD3 = IMD3 @ \text{VBW frequency} - IMD3 @ 100\text{ kHz} < 1\text{ dBc}$ (both sidebands)	VBW	—	30	—	MHz
Gain Flatness in 200 MHz Bandwidth @ $P_{out} = 8\text{ W Avg.}$	G_F	—	0.87	—	dB
Average Deviation from Linear Phase in 200 MHz Bandwidth @ $P_{out} = 40\text{ W CW}$	Φ	—	1.62	—	°
Average Group Delay @ $P_{out} = 40\text{ W CW}$, $f = 3500\text{ MHz}$	Delay	—	1.65	—	ns
Part-to-Part Insertion Phase Variation @ $P_{out} = 40\text{ W CW}$, $f = 3500\text{ MHz}$, Six Sigma Window	$\Delta\Phi$	—	22.9	—	°
Gain Variation over Temperature (-30°C to $+85^\circ\text{C}$)	ΔG	—	0.027	—	dB/°C
Output Power Variation over Temperature (-30°C to $+85^\circ\text{C}$)	ΔP_{1dB}	—	0.121	—	dBm/°C

1. $RCE = 20\text{Log}(EVM/100)$

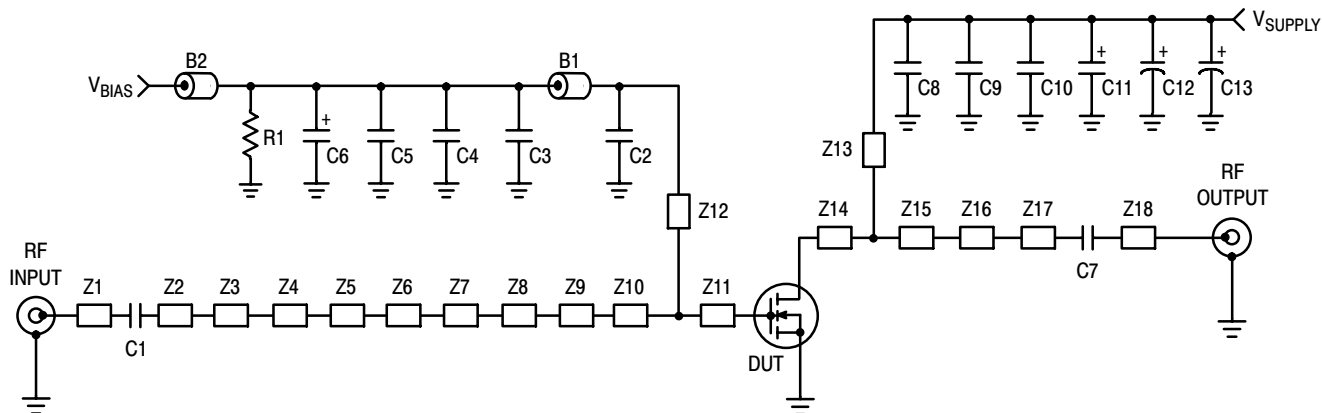

Z1	0.822" x 0.084" Microstrip	Z10, Z11	0.061" x 0.322" Microstrip
Z2	0.454" x 0.386" Microstrip	Z12	0.694" x 0.050" Microstrip
Z3	0.950" x 0.220" Microstrip	Z13	0.268" x 0.071" Microstrip
Z4	0.023" x 0.358" Microstrip	Z14	0.095" x 0.674" Microstrip
Z5	0.400" x 0.379" Microstrip	Z15	0.359" x 0.674" Microstrip
Z6	0.230" x 0.358" Microstrip	Z16	0.640" x 0.241" Microstrip
Z7	0.100" x 0.358" x 0.104" Taper	Z17	0.410" x 0.084" Microstrip
Z8	0.214" x 0.104" Microstrip	Z18	0.726" x 0.084" Microstrip
Z9	0.050" x 0.213" x 0.322" Taper	PCB	Arlon CuClad 250GX-0300-55-22, 0.030", $\epsilon_r = 2.55$

Figure 1. MRF7S38040HR3(HSR3) Test Circuit Schematic

Table 5. MRF7S38040HR3(HSR3) Test Circuit Component Designations and Values

Part	Description	Part Number	Manufacturer
B1, B2	Chip Ferrite Beads	2508051107Y0	Fair-Rite
C1, C2, C7, C8	2.7 pF Chip Capacitors	ATC100B2R7BT500XT	ATC
C3, C9	36 pF Chip Capacitors	ATC100B360BT500XT	ATC
C4, C10	0.01 μ F, 100 V Chip Capacitors	C1825C103J1RAC	Kemet
C5	1K pF Chip Capacitor	ATC100B102BT50XT	ATC
C6	10 μ F, 35 V Tantalum Capacitor	T491C106K035AT	Kemet
C11	22 μ F, 35 V Tantalum Capacitor	T491C226K035AT	Kemet
C12	470 μ F, 63 V Electrolytic Capacitor	EKME630ELL471MK25S	Multicomp
C13	100 μ F, 50 V Electrolytic Capacitor	MCHT101M1HB-1017-RH	Multicomp
R1	180 K Ω , 1/4 W Chip Resistor	CRCW12061803FKEA	Vishay

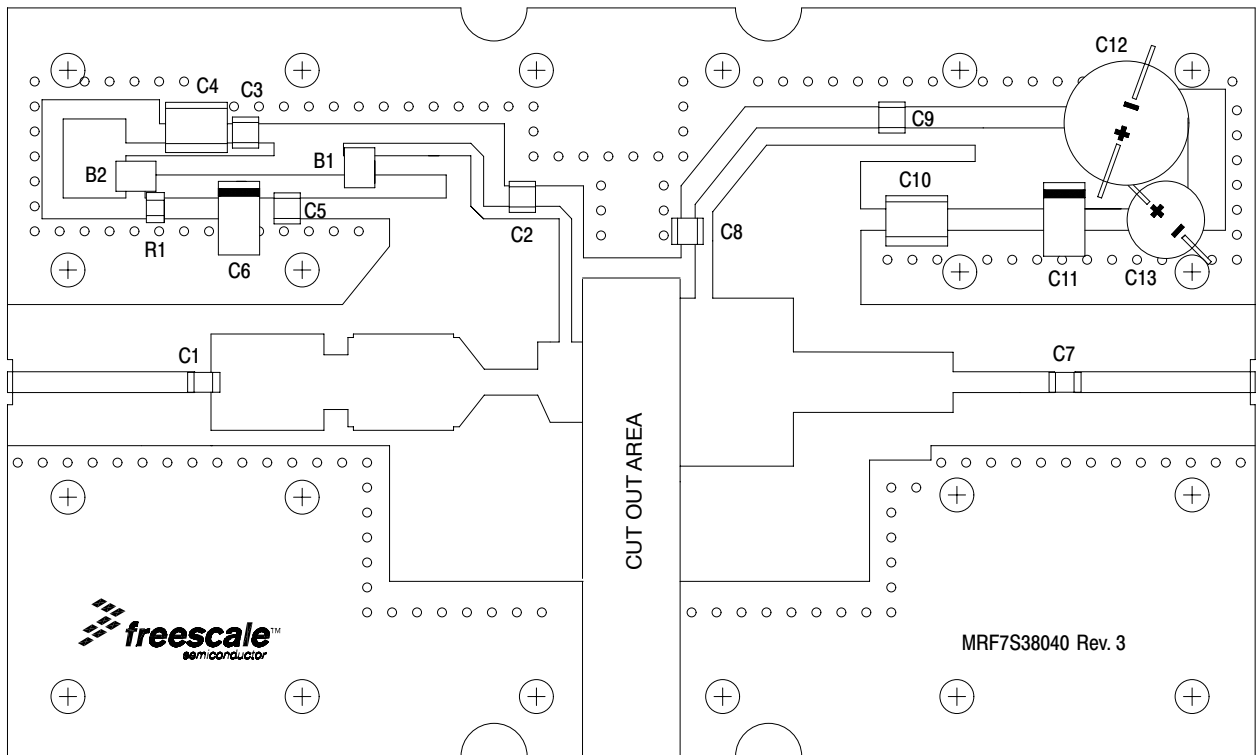

Figure 2. MRF7S38040HR3(HSR3) Test Circuit Component Layout

TYPICAL CHARACTERISTICS

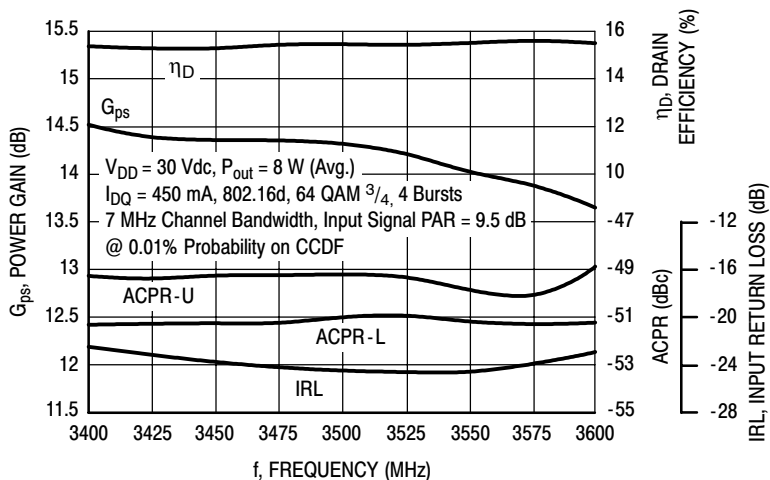

Figure 3. WiMAX Broadband Performance @ $P_{out} = 8$ Watts Avg.

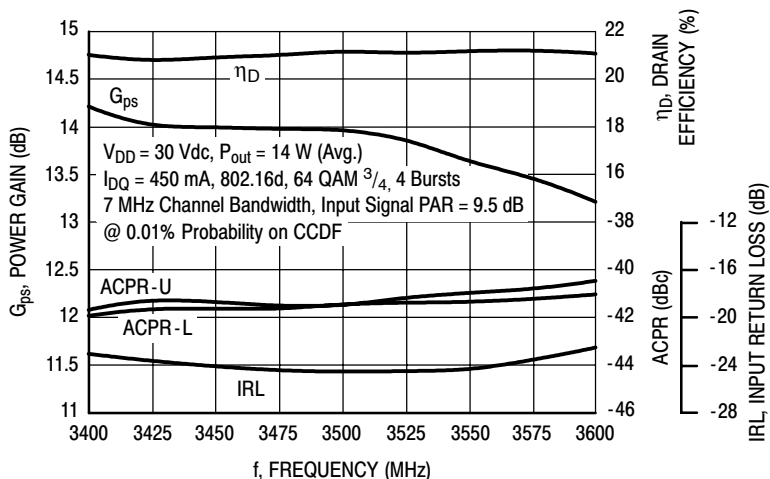

Figure 4. WiMAX Broadband Performance @ $P_{out} = 14$ Watts Avg.

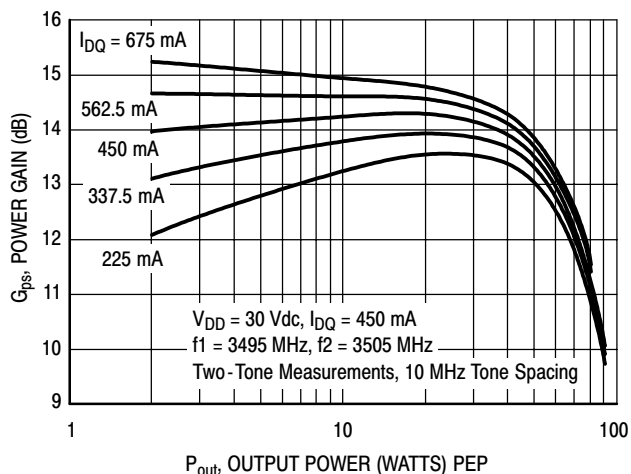

Figure 5. Two-Tone Power Gain versus Output Power

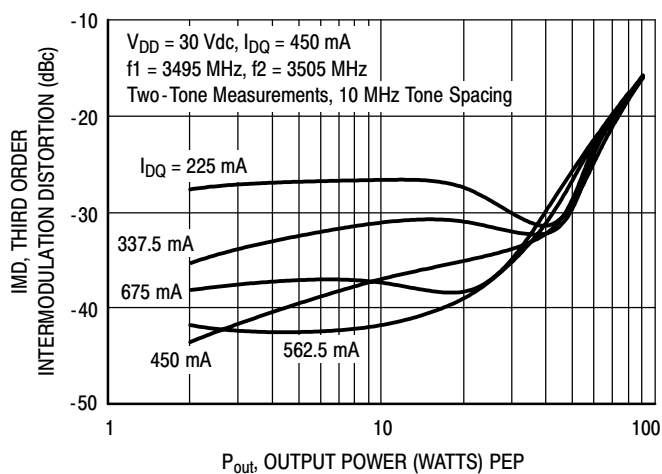

Figure 6. Third Order Intermodulation Distortion versus Output Power

TYPICAL CHARACTERISTICS

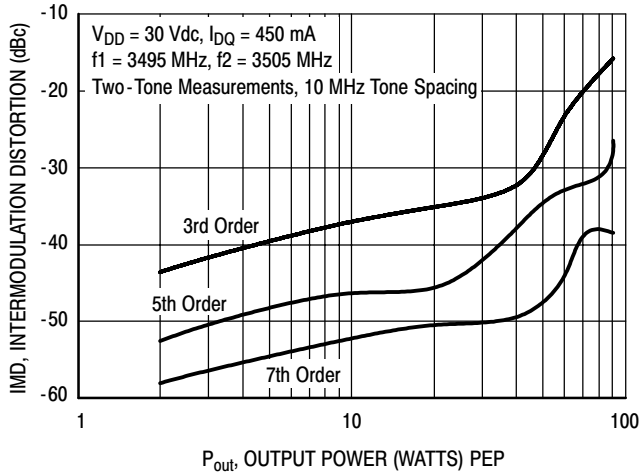

Figure 7. Intermodulation Distortion Products versus Output Power

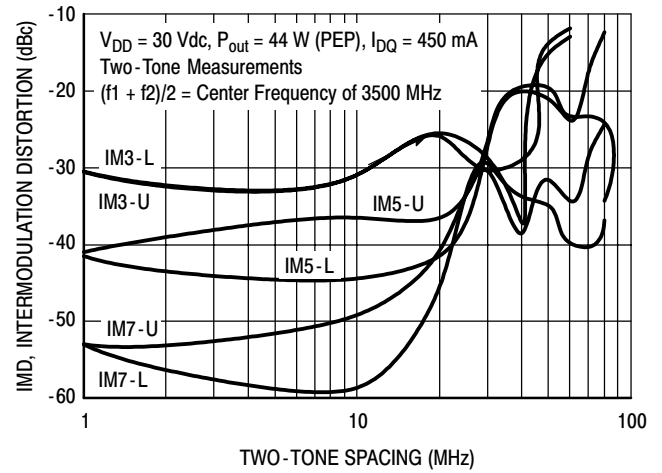

Figure 8. Intermodulation Distortion Products versus Tone Spacing

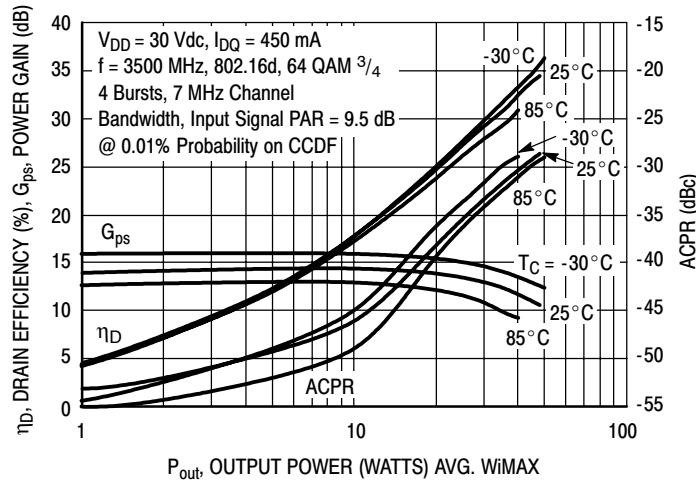

Figure 9. WiMAX, ACPR, Power Gain and Drain Efficiency versus Output Power

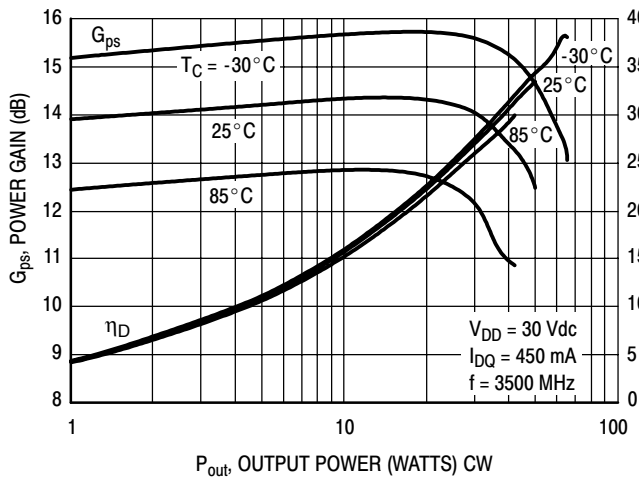

Figure 10. Power Gain and Drain Efficiency versus CW Output Power

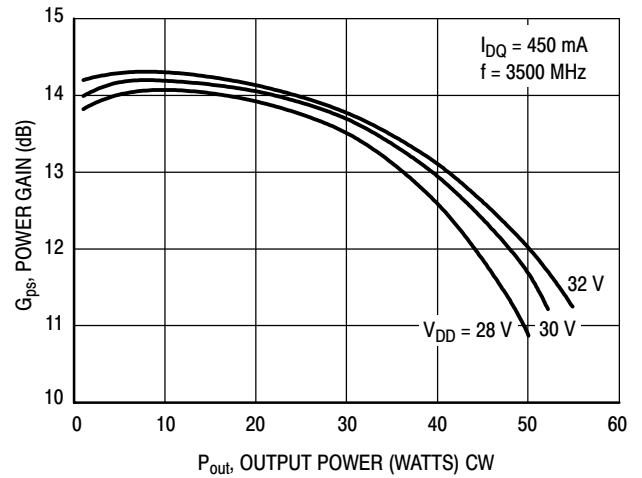
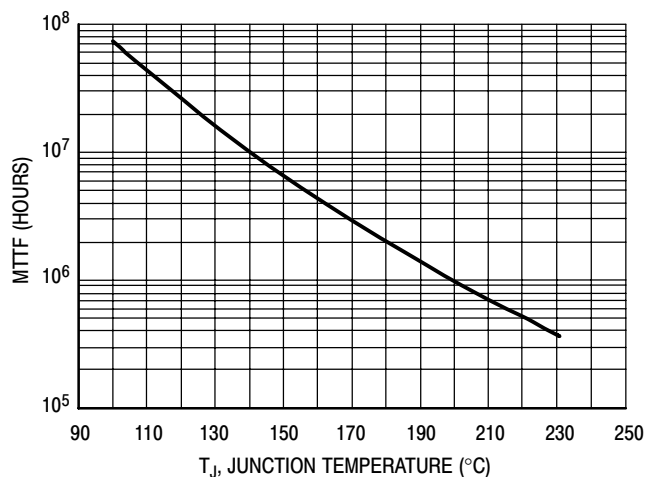

Figure 11. Power Gain versus Output Power

TYPICAL CHARACTERISTICS



This above graph displays calculated MTTF in hours when the device is operated at $V_{DD} = 30$ Vdc, $P_{out} = 8$ W Avg., and $\eta_D = 15.6\%$.

MTTF calculator available at <http://www.freescale.com/rf>. Select Tools/Software/Application Software/Calculators to access the MTTF calculators by product.

Figure 12. MTTF versus Junction Temperature

WIMAX TEST SIGNAL

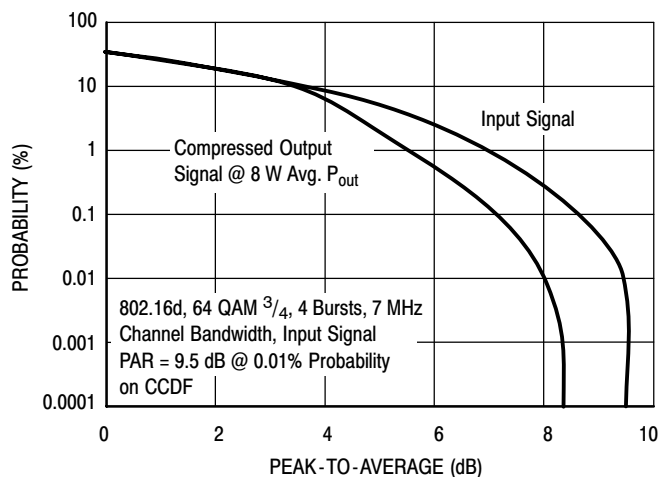

Figure 13. OFDM 802.16d Test Signal

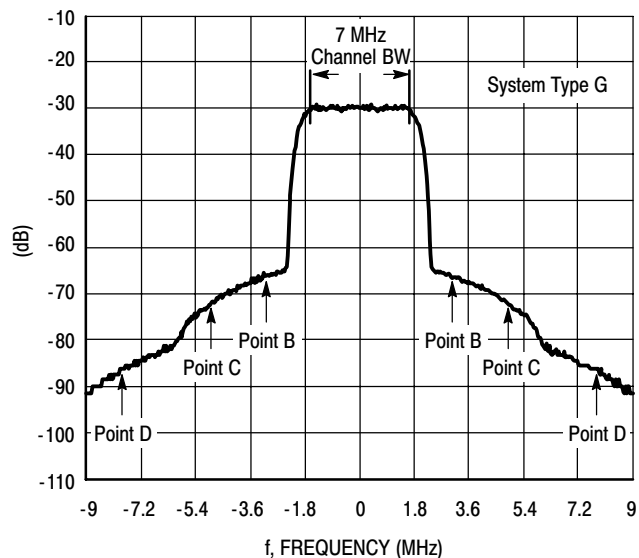
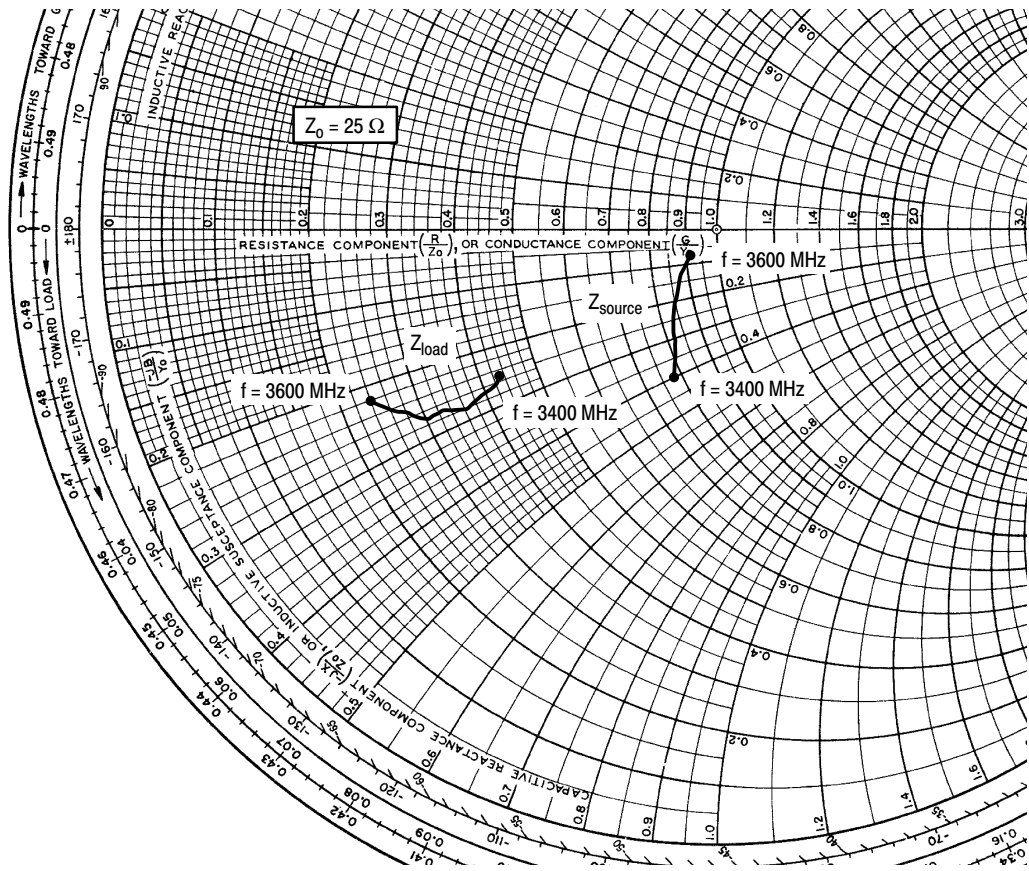

Figure 14. WiMAX Spectrum Mask Specifications



$V_{DD} = 30 \text{ Vdc}$, $I_{DQ} = 450 \text{ mA}$, $P_{out} = 8 \text{ W Avg.}$

f MHz	Z_{source} Ω	Z_{load} Ω
3400	19.57 - j9.98	10.66 - j6.30
3425	20.02 - j9.03	10.41 - j6.55
3450	20.33 - j8.18	9.85 - j6.83
3475	20.45 - j7.42	9.06 - j6.91
3500	20.78 - j6.65	8.30 - j6.84
3525	21.07 - j5.79	7.57 - j6.64
3550	21.45 - j4.55	6.91 - j6.31
3575	22.03 - j3.26	6.39 - j5.92
3600	22.73 - j2.06	5.97 - j5.48

Z_{source} = Test circuit impedance as measured from gate to ground.

Z_{load} = Test circuit impedance as measured from drain to ground.

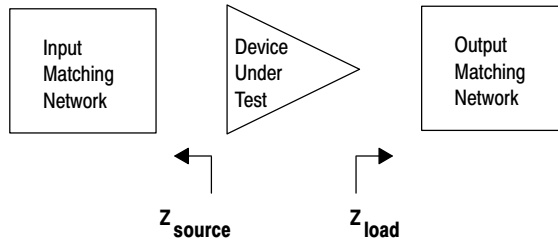
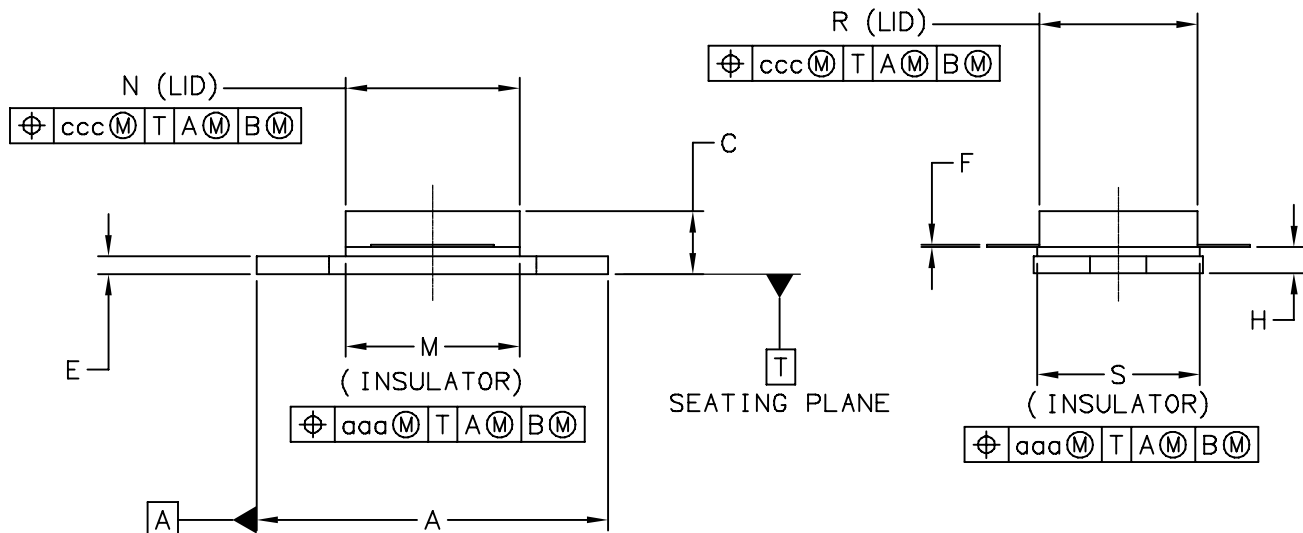
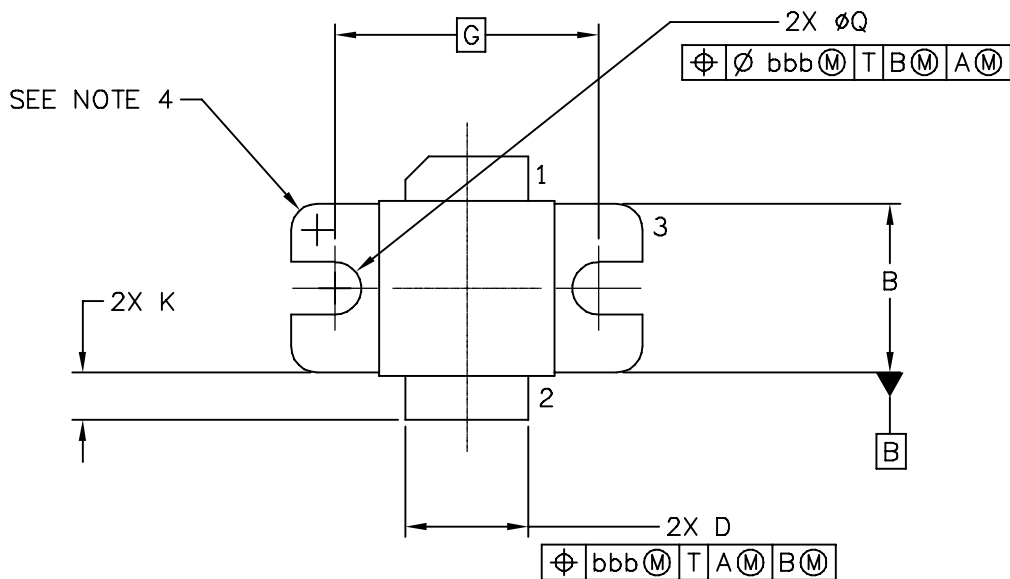

Figure 15. Series Equivalent Source and Load Impedance

PACKAGE DIMENSIONS



© FREESCALE SEMICONDUCTOR, INC. ALL RIGHTS RESERVED.	MECHANICAL OUTLINE	PRINT VERSION NOT TO SCALE	
TITLE: NI-400-240	DOCUMENT NO: 98ASA10730D	REV: B	
	CASE NUMBER: 465I-02	09 MAY 2006	
	STANDARD: NON-JEDEC		

NOTES:

1. CONTROLLING DIMENSION: INCH
2. INTERPRET DIMENSIONS AND TOLERANCES PER ASME Y14.5M-1994.
3. DIMENSION H IS MEASURED .030 (0.762) AWAY FROM PACKAGE BODY.
4. INFORMATION ONLY:
CORNER BREAK (4X) TO BE .060±.005 (1.52±0.13) RADIUS OR
.06±.005 (1.52±0.13) x 45° CHAMFER.

STYLE 1

PIN 1: DRAIN
PIN 2: GATE
PIN 3: SOURCE

STYLE 2

PIN 1: GATE
PIN 2: DRAIN
PIN 3: SOURCE

DIM	INCH		MILLIMETER		DIM	INCH		MILLIMETER	
	MIN	MAX	MIN	MAX		MIN	MAX	MIN	MAX
A	.795	.805	20.19	20.44	R	.355	.365	9.02	9.27
B	.380	.390	9.65	9.91	S	.365	.375	9.27	9.53
C	.125	.163	3.17	4.14					
D	.275	.285	6.98	7.24	aaa	.005		0.127	
E	.035	.045	0.89	1.14	bbb	.010		0.254	
F	.004	.006	0.10	0.15	ccc	.015		0.381	
G	.600 BSC		15.24 BSC						
H	.057	.067	1.45	1.70					
K	.0995	.1295	2.53	3.29					
M	.395	.405	10.03	10.29					
N	.385	.395	9.78	10.03					
Q	∅.120	∅.130	∅3.05	∅3.30					
© FREESCALE SEMICONDUCTOR, INC. ALL RIGHTS RESERVED.			MECHANICAL OUTLINE			PRINT VERSION NOT TO SCALE			
TITLE: NI-400-240					DOCUMENT NO: 98ASA10730D			REV: B	
					CASE NUMBER: 465I-02			09 MAY 2006	
					STANDARD: NON-JEDEC				

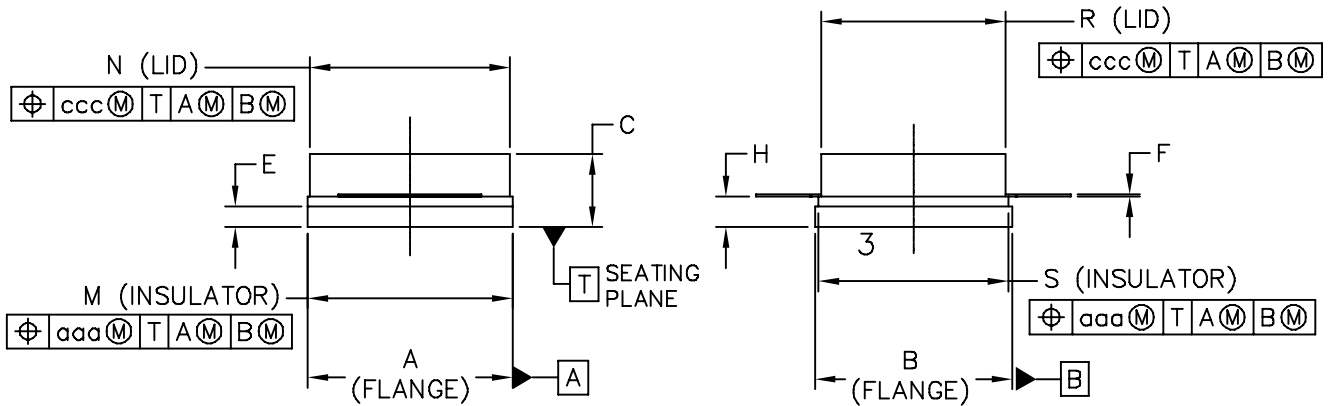
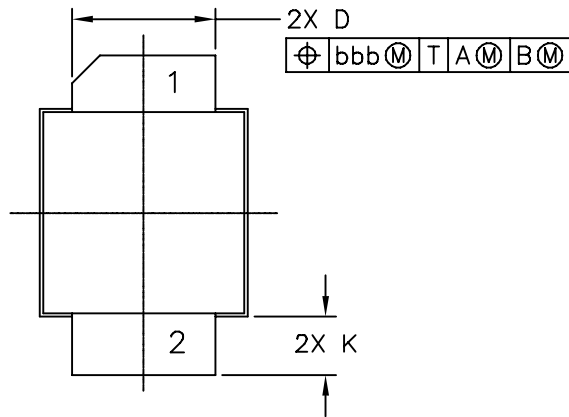

© FREESCALE SEMICONDUCTOR, INC. ALL RIGHTS RESERVED.	MECHANICAL OUTLINE	PRINT VERSION NOT TO SCALE
TITLE: NI-400S-240	DOCUMENT NO: 98ASA10732D	REV: A
	CASE NUMBER: 465J-02	09 MAY 2006
	STANDARD: NON-JEDEC	

NOTES:

1. CONTROLLING DIMENSION: INCH
2. INTERPRET DIMENSIONS AND TOLERANCES PER ASME Y14.5M-1994.
3. DIMENSION H IS MEASURED .030 (0.762) AWAY FROM PACKAGE BODY

STYLE 1:

- PIN 1 - DRAIN
- 2 - GATE
- 3 - SOURCE

STYLE 2:

- PIN 1 - GATE
- 2 - DRAIN
- 3 - SOURCE

DIM	INCH		MILLIMETER		DIM	INCH		MILLIMETER	
	MIN	MAX	MIN	MAX		MIN	MAX	MIN	MAX
A	.395	.405	10.03	10.29	aaa	.005			0.127
B	.380	.390	9.65	9.91	bbb	.010			0.254
C	.125	.163	3.18	4.14	ccc	.015			0.381
D	.275	.285	6.98	7.24					
E	.035	.045	0.89	1.14					
F	.004	.006	0.10	0.15					
H	.057	.067	1.45	1.70					
K	.0995	.1295	2.53	3.29					
M	.395	.405	10.03	10.29					
N	.385	.395	9.78	10.03					
R	.355	.365	9.02	9.27					
S	.365	.375	9.27	9.53					
© FREESCALE SEMICONDUCTOR, INC. ALL RIGHTS RESERVED.			MECHANICAL OUTLINE			PRINT VERSION NOT TO SCALE			
TITLE: NI-400S-240					DOCUMENT NO: 98ASA10732D			REV: A	
					CASE NUMBER: 465J-02			09 MAY 2006	
					STANDARD: NON-JEDEC				

PRODUCT DOCUMENTATION

Refer to the following documents to aid your design process.

Application Notes

- AN1955: Thermal Measurement Methodology of RF Power Amplifiers

Engineering Bulletins

- EB212: Using Data Sheet Impedances for RF LDMOS Devices

REVISION HISTORY

The following table summarizes revisions to this document.

Revision	Date	Description
0	Aug. 2007	<ul style="list-style-type: none">• Initial Release of Data Sheet

How to Reach Us:

Home Page:

www.freescale.com

Web Support:

<http://www.freescale.com/support>

USA/Europe or Locations Not Listed:

Freescale Semiconductor, Inc.
Technical Information Center, EL516
2100 East Elliot Road
Tempe, Arizona 85284
+1-800-521-6274 or +1-480-768-2130
www.freescale.com/support

Europe, Middle East, and Africa:

Freescale Halbleiter Deutschland GmbH
Technical Information Center
Schatzbogen 7
81829 Muenchen, Germany
+44 1296 380 456 (English)
+46 8 52200080 (English)
+49 89 92103 559 (German)
+33 1 69 35 48 48 (French)
www.freescale.com/support

Japan:

Freescale Semiconductor Japan Ltd.
Headquarters
ARCO Tower 15F
1-8-1, Shimo-Meguro, Meguro-ku,
Tokyo 153-0064
Japan
0120 191014 or +81 3 5437 9125
support.japan@freescale.com

Asia/Pacific:

Freescale Semiconductor Hong Kong Ltd.
Technical Information Center
2 Dai King Street
Tai Po Industrial Estate
Tai Po, N.T., Hong Kong
+800 2666 8080
support.asia@freescale.com

For Literature Requests Only:

Freescale Semiconductor Literature Distribution Center
P.O. Box 5405
Denver, Colorado 80217
1-800-441-2447 or 303-675-2140
Fax: 303-675-2150
LDCForFreescaleSemiconductor@hibbertgroup.com

Information in this document is provided solely to enable system and software implementers to use Freescale Semiconductor products. There are no express or implied copyright licenses granted hereunder to design or fabricate any integrated circuits or integrated circuits based on the information in this document.

Freescale Semiconductor reserves the right to make changes without further notice to any products herein. Freescale Semiconductor makes no warranty, representation or guarantee regarding the suitability of its products for any particular purpose, nor does Freescale Semiconductor assume any liability arising out of the application or use of any product or circuit, and specifically disclaims any and all liability, including without limitation consequential or incidental damages. "Typical" parameters that may be provided in Freescale Semiconductor data sheets and/or specifications can and do vary in different applications and actual performance may vary over time. All operating parameters, including "Typicals", must be validated for each customer application by customer's technical experts. Freescale Semiconductor does not convey any license under its patent rights nor the rights of others. Freescale Semiconductor products are not designed, intended, or authorized for use as components in systems intended for surgical implant into the body, or other applications intended to support or sustain life, or for any other application in which the failure of the Freescale Semiconductor product could create a situation where personal injury or death may occur. Should Buyer purchase or use Freescale Semiconductor products for any such unintended or unauthorized application, Buyer shall indemnify and hold Freescale Semiconductor and its officers, employees, subsidiaries, affiliates, and distributors harmless against all claims, costs, damages, and expenses, and reasonable attorney fees arising out of, directly or indirectly, any claim of personal injury or death associated with such unintended or unauthorized use, even if such claim alleges that Freescale Semiconductor was negligent regarding the design or manufacture of the part.

Freescale™ and the Freescale logo are trademarks of Freescale Semiconductor, Inc. All other product or service names are the property of their respective owners.

© Freescale Semiconductor, Inc. 2007. All rights reserved.

