



Product Description: T370HW02_V4 TFT-LCD PANEL			
AUO Model Name: T370HW02_V4			
Customer Part No/Project Name:			
Customer Signature	Date	AUO	Date
		Approved By: Frank Hsu <i>Frank Hsu</i>	
		Reviewed By: Horg Jye Hong <i>Horg Jye Hong</i> 12/10/2007 Reviewed By: Project leader/Chia Hung Sun <i>Chia Hung Sun</i>	
		Prepared By: PM/Eve Tung <i>Eve Tung</i>	



Update date: 2007/12/18

Product Specifications

**37" HDTV Color TFT-LCD Module
Model Name: T370HW02. V4**

() Preliminary Specifications

— (*) Final Specifications



Contents

No	
	COVER
	CONTENTS
	RECORD OF REVISIONS
1	GENERAL DESCRIPTION
2	ABSOLUTE MAXIMUM RATINGS
3	ELECTRICAL SPECIFICATIONS
3-1	ELECTRICAL CHARACTERISTIC
3-2	INTERFACE CONNECTIONS
3-3	SIGNAL TIMING SPECIFICATIONS
3-4	SIGNAL TIMING WAVEFORMS
3-5	COLOR INPUT DATA REFERENCE
3-6	POWER SEQUENCE
4	OPTICAL CHARACTERISTICS
5	MECHANICAL CHARACTERISTICS
6	RELIABILITY
7	INTERNATIONAL STANDARDS
7-1	SAFETY
7-2	EMC
8	PACKING
9	PRECAUTIONS



1. General Description

This specification applies to the 37.0 inch Color TFT-LCD Module T370HW02 V4. This LCD module has a TFT active matrix type liquid crystal panel 1920x1080 pixels, and diagonal size of 37.0 inch. This module supports 1920x1080 HDTV mode (Non-interlace). Each pixel is divided into Red, Green and Blue sub-pixels or dots which are arranged in vertical stripes. Gray scale or the brightness of the sub-pixel color is determined with a 8-bit gray scale signal for each dot.

The T370HW02 V4 has been designed to apply the 8-bit 2 channel LVDS interface method. It is intended to support displays where high brightness, wide viewing angle, high color saturation, and high color depth are very important.

The T370HW02 V4 model is RoHS verified which can be distinguished on panel label.

* General Information

Items	Specification	Unit	Note
Active Screen Size	37.01	inch	
Display Area	819.36 (H) x 460.89(V)	mm	
Outline Dimension	877(H) x 514.6(V) x 54.3(D)	mm	With inverter
Driver Element	a-Si TFT active matrix		
Display Colors	8 bit, 16.7M	Colors	
Number of Pixels	1920 x 1080	Pixel	
Pixel Pitch	0.42675(H) x 0.42675(W)	mm	
Pixel Arrangement	RGB vertical stripe		
Display Operation Mode	Transmissive, Normally Black		
Surface Treatment	AG-SR6, 3H		Haze = 11



2. Absolute Maximum Ratings

The following are maximum values that, if exceeded, may cause permanent damage to the device.

Item	Symbol	Min	Max	Unit	Note
Logic/LCD Drive Voltage	Vcc	-0.3	14	[Volt]	[1]
Input Voltage of Signal	Vin	-0.3	4	[Volt]	[1]
BLU Input Voltage	VDDDB	-0.3	27	[Volt]	[1]
BLU Brightness Control Voltage	VBLON	-0.3	7.0	[Volt]	[1]
Operating Temperature	TOP	0	50	[°C]	[2]
Operating Humidity	HOP	10	90	[%RH]	[2]
Storage Temperature	TST	-20	60	[°C]	[2]
Storage Humidity	HST	10	90	[%RH]	[2]
Panel surface temperature	PST		65	[°C]	

Note 1: Duration = 50msec

Note 2 : Maximum Wet-Bulb should be 39°C and No condensation.

The relative humidity must not exceed 90% non-condensing at temperatures of 40°C or less. At temperatures greater than 40°C, the wet bulb temperature must not exceed 39°C.

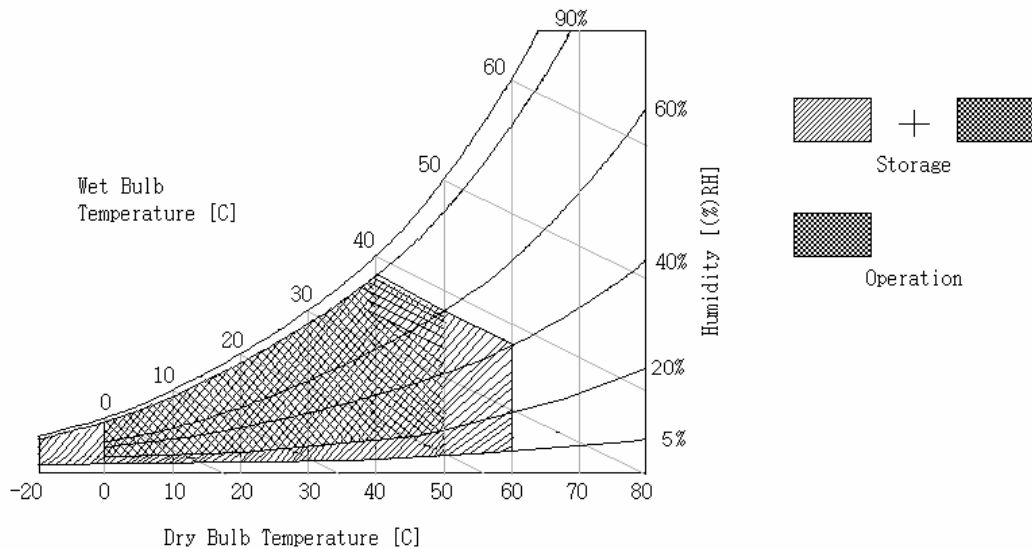

3. Electrical Characteristics

The T370HW02 V4 requires two power inputs. One is employed to power the LCD electronics and to drive the TFT array and liquid crystal. The second input power for the BLU, is to power inverter.

3-1 Electrical Characteristics

($T_a=25\pm 2^\circ\text{C}$)

Parameter		Symbol	Values			Unit	Notes
			Min	Typ	Max		
Power Supply Input Voltage		V_{CC}	10.8	12.0	13.2	Vdc	
Power Supply Input Current		I_{CC}		1	1.2	A	[1]
Power Consumption		P_C	-	12	14.4	Watt	[1]
Inrush Current		I_{RUSH}	-		4	Apeak	[2]
LVDS Interface	Differential Input High Threshold Voltage	V_{TH}			100	mV	[3]
	Differential Input Low Threshold Voltage	V_{TL}	-100			mV	[3]
	Common Input Voltage	V_{ICM}	1.1	1.25	1.4	V	
	CMOS Interface	Input High Threshold Voltage	V_{IH} (High)	2.4		3.3	Vdc
CMOS Interface	Input Low Threshold Voltage	V_{IL} (Low)	0		0.9	Vdc	
Life Time			50000			Hours	

Note :

1. The ripple voltage should be controlled under 10% of V_{CC}
2. $V_{CC}=12.0\text{V}$, $f_v = 60\text{Hz}$, $f_{CLK}=65\text{Mhz}$, 25°C , Test Pattern : White Pattern
3. Measurement condition :

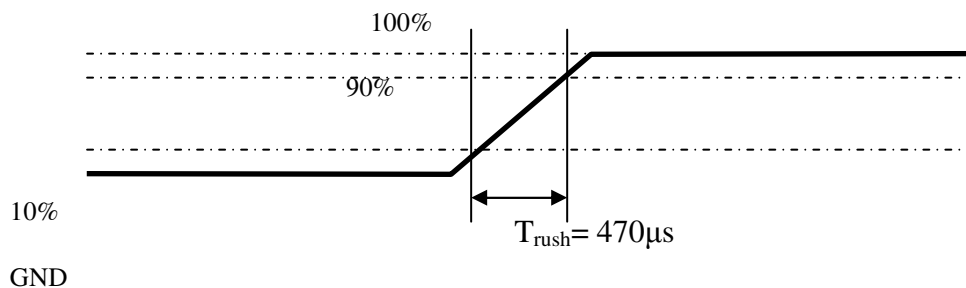

Figure 1: Measurement of I_{rush}

- Measurement of LVDS differential voltage is shown in Figure 2.

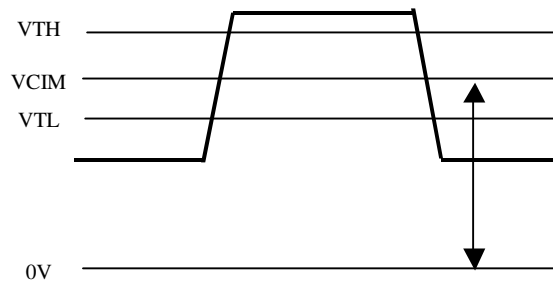

Figure 2 : LVDS Differential Voltage

- The performance of the Lamp in LCM, for example life time or brightness, is extremely influenced by the characteristics of the DC-AC Inverter. So all the parameters of an inverter should be carefully designed so as not to produce too much leakage current from high-voltage output of the inverter. When you design or order the inverter, please make sure unwanted lighting caused by the mismatch of the lamp and the inverter (no lighting, flicker, etc) never occurs. When you confirm it, the LCD Assembly should be operated in the same condition as installed in your instrument.
- Do not attach a conducting tape to lamp connecting wire. If the lamp wire attach to conducting tape, TFT-LCD Module have a low luminance and the inverter has abnormal action because leakage current occurs between lamp wire and conducting tape.
- The relative humidity must not exceed 80% non-condensing at temperatures of 40°C or less. At temperatures greater than 40°C, the wet bulb temperature must not exceed 39°C. When operate at low temperatures, the brightness of CCFL will drop and the life time of CCFL will be reduced.
- The measured data is without boost function
- W/O boost function Lifetime is defined and judged for lamp when analog and PWM dimming are maximum values. With boost function Lifetime is defined and judged for lamp when boost function is high (3.3V)



3-2 Interface Connections

LCD connector (CN3): JAE FI-RE51S-HF

No	Signal	No	Signal
1	GND	27	GND
2	Reserved.	28	RE0-
3	Reserved.	29	RE0+
4	Reserved.	30	RE1-
5	Reserved.	31	RE1+
6	Reserved.	32	RE2-
7	LVDS SEL	33	RE2+
8	Reserved.	34	GND
9	Reserved.	35	RECLKIN-
10	Reserved.	36	RECLKIN+
11	GND	37	GND
12	RO0-	38	RE3-
13	RO0+	39	RE3+
14	RO1-	40	N.C.
15	RO1+	41	N.C.
16	RO2-	42	GND
17	RO2+	43	GND
18	GND	44	GND
19	ROCLKIN-	45	GND
20	ROCLKIN+	46	GND
21	GND	47	N.C.
22	RO3-	48	VLCD(12V)
23	RO3+	49	VLCD(12V)
24	N.C.	50	VLCD(12V)
25	N.C.	51	VLCD(12V)
26	GND		

Note:

1. All GND (ground) pins should be connected together and should also be connected to the LCD's metal frame. All Vcc (power input) pins should be connected together.
2. NC Only – Pull High or Low is not allowed



LVDS Option = L (GND) or OPEN = NS

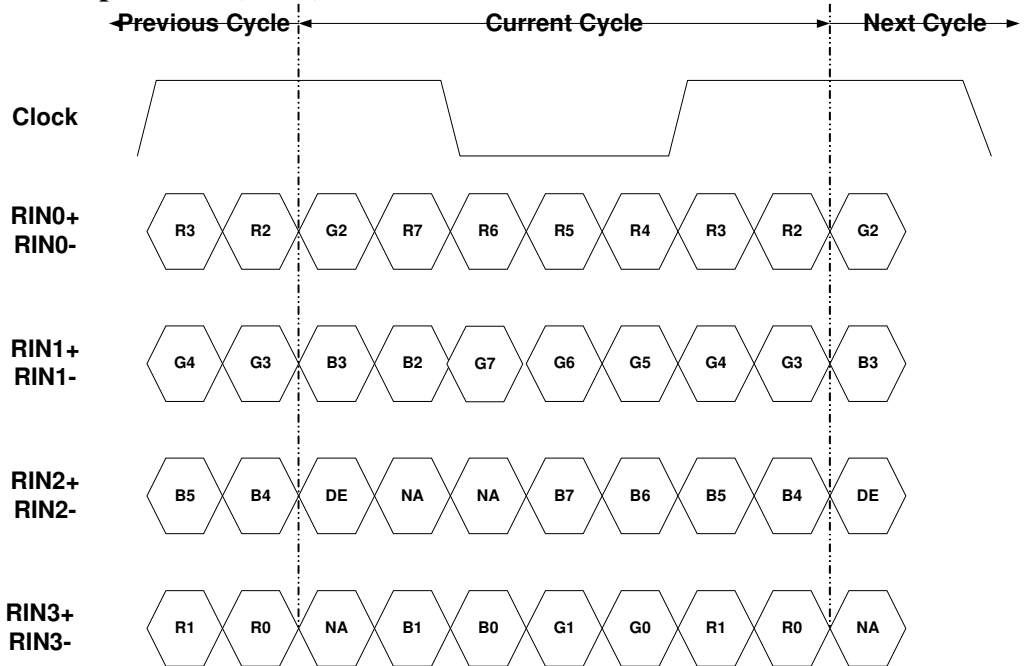

LVDS Option = H (3.3V) → JEIDA

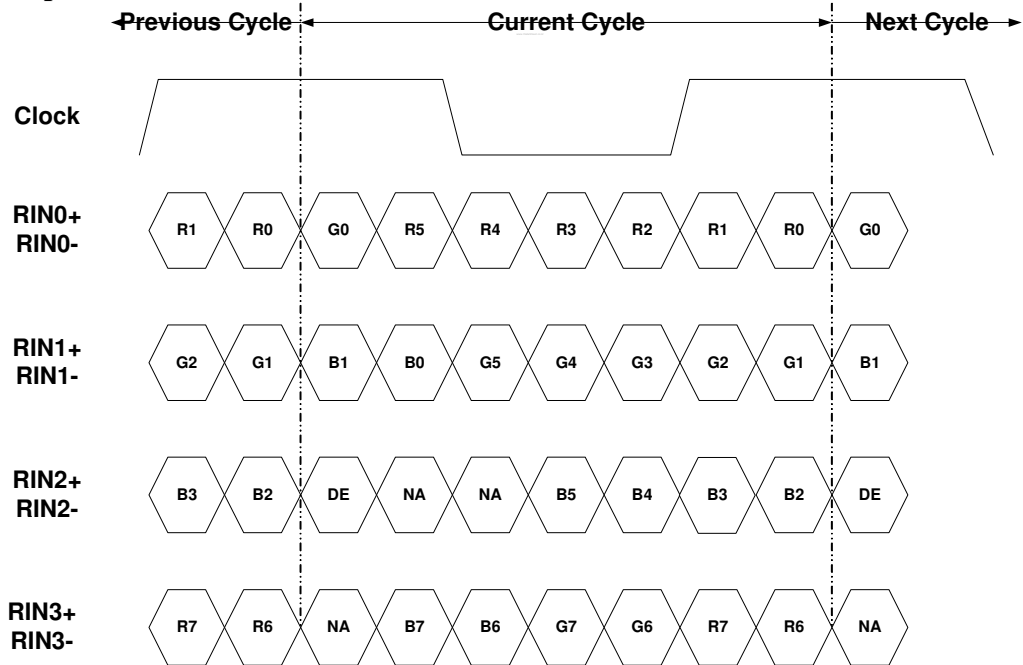



BACKLIGHT CONNECTOR PIN CONFIGURATION

1. Electrical specification

Item	Symbol	Condition	Spec			Unit	Note	
			Min	Typical	Max			
Input Voltage	V_{DDB}		21.6	24	26.4	VDC		
Input Current	I_{DDB}	VDDDB=24V	-	6.04	6.62	ADC	1	
Input Power	P_{DDB}	VDDDB=24V	-	145	159	W	1	
Inrush current	I_{RUSH}	VDDDB=24V	-	-	8.5	ADC	2	
Output Frequency	F_{BL}	VDDDB=24V	42	44	46-	KHz		
On/Off control voltage	V_{BLON}	ON	VDDDB=24V	2	-	5	VDC	
		OFF		0	-	0.8		
Dimming Control Voltage	V_{DIM}	MAX	VDDDB=24V	2	-	3.3	VDC	
		MIN		0		0.8	VDC	
Dimming Frequent	F_D	VDDDB=24V		180		Hz		
PWM control Voltage	V_{EPWM}	MAX	VDDDB=24V	-	3.3	-	VDC	
		MIN	VDDDB=24V	-	0	-		
External PWM control Current	I_{EPWM}	VDDDB=24V			2	mADC		
External PWM Duty ratio	D_{EPWM}	VDDDB=24V	10		100	%		
External PWM Frequency	F_{EPWM}	VDDDB=24V	170	180	190	Hz		

Note 1: V_{DIM} = 3.3V; EPWM = Open/High (Turn on for 45minutes)

Note 2 : Measurement condition Rising time = 20 ms (V_{DDB} : 10%~90%);

Note 3 : (a) Uniformity and flicker does not guarantee under 10% dimming control.

(b) 10% dimming function okay and no backlight shut down



2. Inverter units

Connector is shown below: CI0114M1HR0-LF

Matt : JST or Civilux or equivalent

Pin No	Symbol	Description
1	VBL	24V
2	VBL	24V
3	VBL	24V
4	VBL	24V
5	VBL	24V
6	GND	Ground
7	GND	Ground
8	GND	Ground
9	GND	Ground
10	GND	Ground
11	NC	N.C.
12	VBLON	BL on-off : high/open(3.3 ~ 5V) for BL on,low(GND) for off
13	Internal PWM	high (3.3V,100% duty)for 100%
14	NC	N.C.

Note: pin 13 & pin 14 can not connect at the same time



3-3 Signal Timing Specifications

This is the signal timing required at the input of the User connector. All of the interface signal timing should be satisfied with the following specifications for its proper operation.

Timing Table (DE only Mode)

A. Frame Rate = 60 Hz

Signal	Item	Symbol	Min	Type	Max	Unit
Vertical Section	Period	Tv	1090	1130	1200	Th
	Active	Tdisp (v)	1080			Th
	Blanking	Tblk (v)	10	50	120	Th
Horizontal Section	Period	Th	1030	1100	1180	Tclk
	Active	Tdisp (h)	960			Tclk
	Blanking	Tblk (h)	70	140	220	Tclk
Clock	Frequency	1/Tclk	67.362	74.58	84.96	MHz
Vertical Frequency	Frequency	Freq	60	60	60	Hz
Horizontal Frequency	Frequency	Freq	65.4	67.8	72	KHz

B. Frame Rate = 50 Hz

Signal	Item	Symbol	Min	Type	Max	Unit
Vertical Section	Period	Tv	1316	1356	1426	Th
	Active	Tdisp (v)	1080			Th
	Blanking	Tblk (v)	236	276	346	Th
Horizontal Section	Period	Th	1030	1100	1180	Tclk
	Active	Tdisp (h)	960			Tclk
	Blanking	Tblk (h)	70	140	220	Tclk
Clock	Frequency	1/Tclk	67.774	74.58	84.134	MHz
Vertical Frequency	Frequency	Freq	50	50	50	Hz
Horizontal Frequency	Frequency	Freq	65.8	67.8	71.3	KHz

1.) Display position is specific by the rise of DE signal only.

Horizontal display position is specified by the falling edge of 1st DCLK right after the rise of ENAB, is displayed on the left edge of the screen.

Vertical display position is specified by the rise of DE after a “Low” level period equivalent to eight times of horizontal period. The 1st data corresponding to one horizontal line after the rise the of ENAB is displayed at the top line of screen.

3.) If a period of DEB “High” is less than 1920 DCLK or less than 1080 lines, the rest of the screen displays black.

4.) The display position does not fit to the screen if a period of DE “High” and the effective data period do not synchronize with each other.

3-4 Signal Timing Waveforms

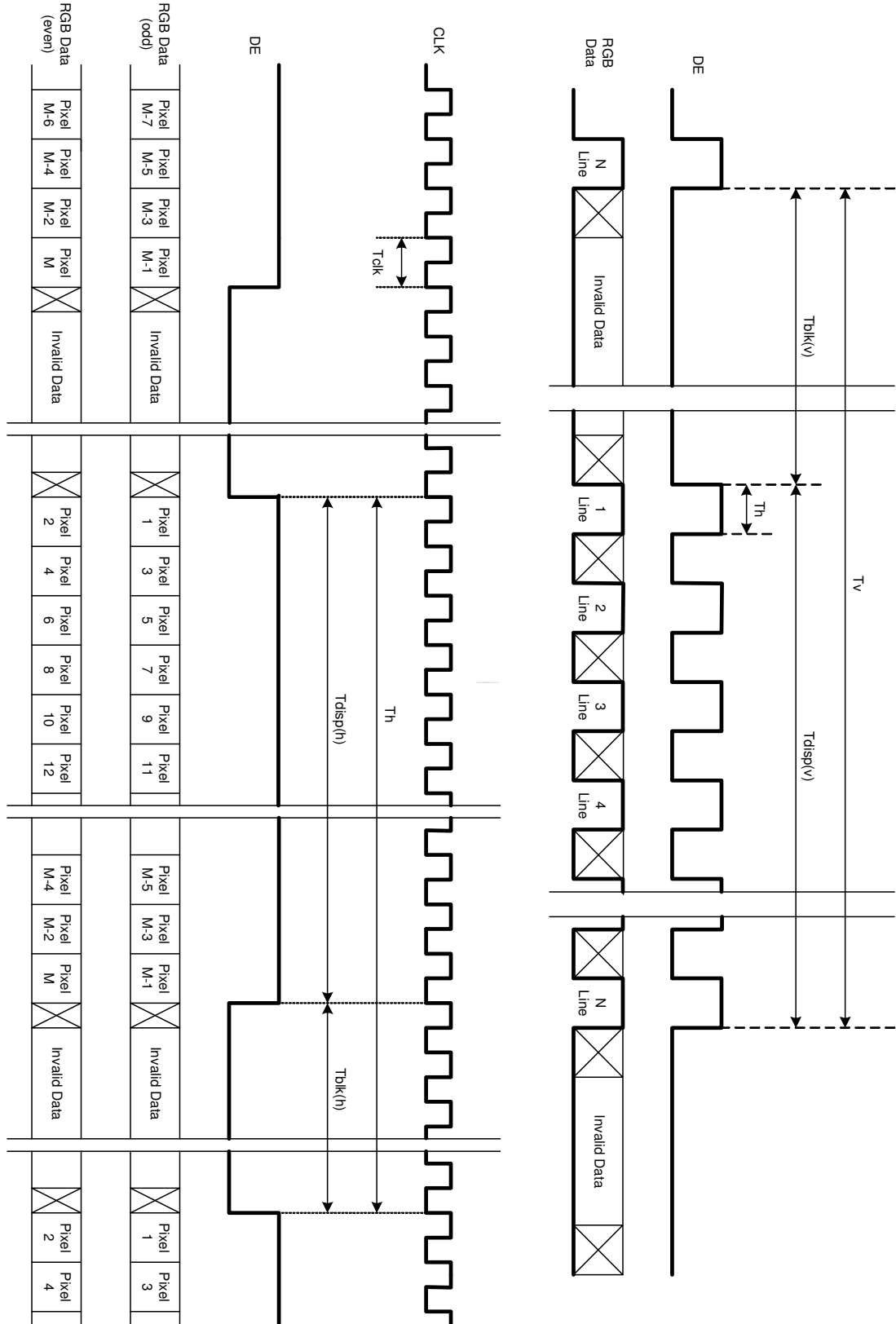



3-5 Color input data assignment

The brightness of each primary color (red, green and blue) is based on the 8 bit gray scale data input for the color; the higher the binary input, the brighter the color. The table below provides a reference for color versus data input.

COLOR DATA REFERENCE

Color		Input Color Data																							
		RED								GREEN								BLUE							
		MSB				LSB				MSB				LSB				MSB				LSB			
		R7	R6	R5	R4	R3	R2	R1	R0	G7	G6	G5	G4	G3	G2	G1	G0	B7	B6	B5	B4	B3	B2	B1	B0
Basic Color	Black	0	0	0	0	0	0	0	0	0	0	0	0	0	0	0	0	0	0	0	0	0	0	0	0
	Red(255)	1	1	1	1	1	1	1	1	0	0	0	0	0	0	0	0	0	0	0	0	0	0	0	0
	Green(255)	0	0	0	0	0	0	0	0	1	1	1	1	1	1	1	1	0	0	0	0	0	0	0	0
	Blue(255)	0	0	0	0	0	0	0	0	0	0	0	0	0	0	0	0	1	1	1	1	1	1	1	1
	Cyan	0	0	0	0	0	0	0	0	1	1	1	1	1	1	1	1	1	1	1	1	1	1	1	1
	Magenta	1	1	1	1	1	1	1	1	0	0	0	0	0	0	0	0	1	1	1	1	1	1	1	1
	Yellow	1	1	1	1	1	1	1	1	1	1	1	1	1	1	1	1	0	0	0	0	0	0	0	0
	White	1	1	1	1	1	1	1	1	1	1	1	1	1	1	1	1	1	1	1	1	1	1	1	1
RED	RED(000)	0	0	0	0	0	0	0	0	0	0	0	0	0	0	0	0	0	0	0	0	0	0	0	0
	RED(001)	0	0	0	0	0	0	0	1	0	0	0	0	0	0	0	0	0	0	0	0	0	0	0	0

	RED(254)	1	1	1	1	1	1	1	0	0	0	0	0	0	0	0	0	0	0	0	0	0	0	0	0
	RED(255)	1	1	1	1	1	1	1	1	0	0	0	0	0	0	0	0	0	0	0	0	0	0	0	0
GREEN	GREEN(000)	0	0	0	0	0	0	0	0	0	0	0	0	0	0	0	0	0	0	0	0	0	0	0	0
	GREEN(001)	0	0	0	0	0	0	0	0	0	0	0	0	0	0	0	1	0	0	0	0	0	0	0	0

	GREEN(254)	0	0	0	0	0	0	0	0	1	1	1	1	1	1	1	0	0	0	0	0	0	0	0	0
	GREEN(255)	0	0	0	0	0	0	0	0	1	1	1	1	1	1	1	1	0	0	0	0	0	0	0	0
BLUE	BLUE(000)	0	0	0	0	0	0	0	0	0	0	0	0	0	0	0	0	0	0	0	0	0	0	0	0
	BLUE(001)	0	0	0	0	0	0	0	0	0	0	0	0	0	0	0	0	0	0	0	0	0	0	0	1

	BLUE(254)	0	0	0	0	0	0	0	0	0	0	0	0	0	0	0	0	1	1	1	1	1	1	1	0
	BLUE(255)	0	0	0	0	0	0	0	0	0	0	0	0	0	0	0	0	1	1	1	1	1	1	1	1



3-6 Power Sequence of LCD Module of AUO-043(ON/OFF)

3.6.1 Power Sequence for LCD

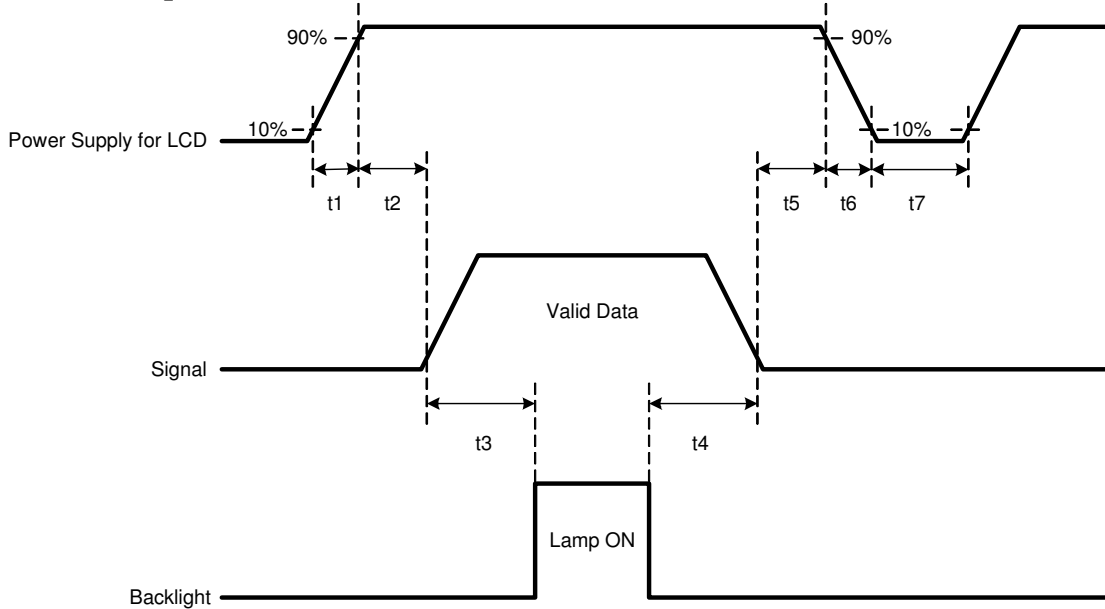

Parameter	Values			Units Min.
	Min.	Typ.	Max.	
T1	470	-	5000	us
T2	20	-	35	ms
T3	500	-	-	ms
T4	200	-	-	ms
T5	5	-	-	ms
T6	-	-	30	ms
T7	1	-	-	s

Note:

The timing controller will not be damaged in case of TV set AC input power suddenly shut down. Once power reset, it should follow power sequence as spec. definition.

- (1) Apply the lamp voltage within the LCD operation range. When the back-light turns on before the LCD operation or the LCD turns off before the back-light turns off, the display may momentarily become abnormal screen.

3.6.2 Power Sequence of Inverter

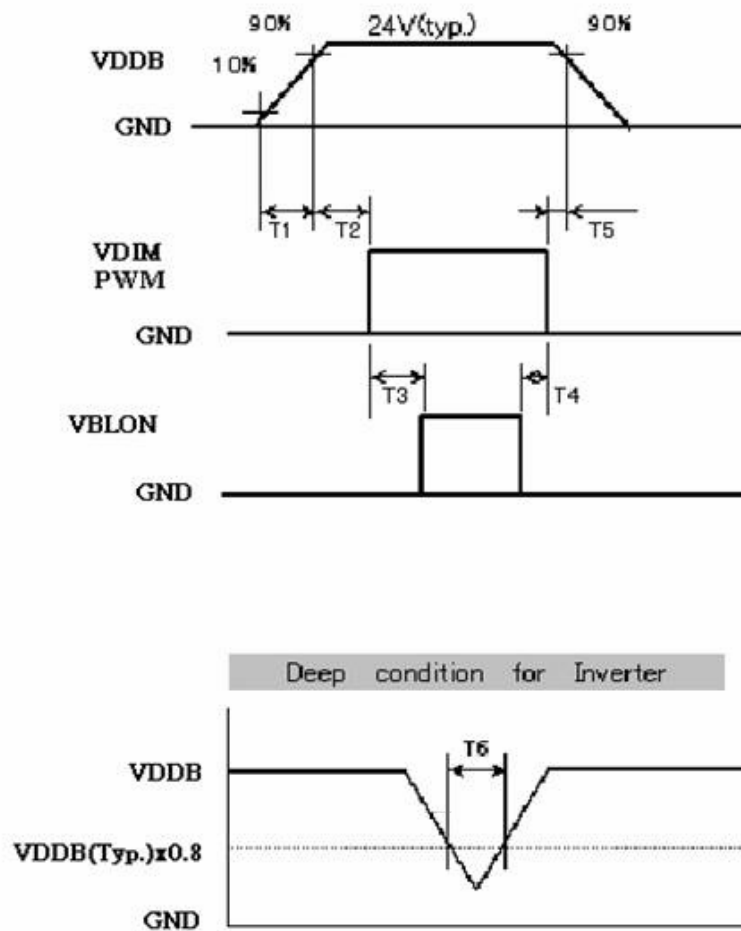

Parameter	Values			Units
	Min.	Typ.	Max.	
T1	20	-	-	ms
T2	500	-	-	ms
T3	250	-	-	ms
T4	0	-	-	ms
T5	1	-	-	ms
T6	-	-	10	ms

4. Optical Specification

Optical characteristics are determined after the unit has been 'ON' and stable for approximately 45 minutes in a dark environment at 25°C. The values specified are at an approximate distance 50cm from the LCD surface at a viewing angle of Φ and θ equal to 0°.

Testing Condition:

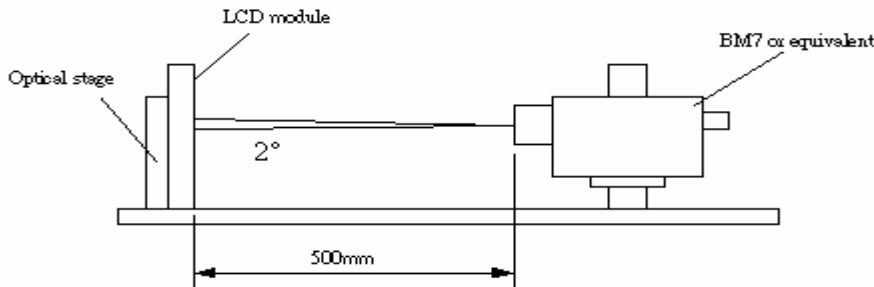

FIG.1 Measurement equipment

Parameter	Symbol	Condition	Value			Units	Notes
			Min.	Typ.	Max.		
Contrast Ratio	CR	$\varphi = 0^\circ, \theta = 0^\circ$ Viewing Normal angle	2200	2500			1
Surface Luminance, white	LWH		400	500		cd/m ²	2
Luminance Variation	δ_{WHITE} 9 pts				1.3	cd/m ²	3
Response Time	Gray to Gray		T_γ		6.5	ms	4
Color gamma	NTSC				72	%	
Color Coordinates (CIE 1931)	RED	R_X	Typ -0.03	0.64	Typ +0.03		
		R_Y		0.33			
	GREEN	G_X		0.29			
		G_Y		0.6			
	BLUE	B_X		0.15			
		B_Y		0.06			
	WHITE	W_X		0.280			
W_Y		0.290					
Viewing Angle	x axis, right	θ_r ($\varphi = 0^\circ$)	CR ≥ 10	89	Degree		5
	x axis, left	θ_l ($\varphi = 180^\circ$)		89			
	y axis, up	θ_u ($\varphi = 90^\circ$)		89			
	y axis, down	θ_d ($\varphi = 0^\circ$)		89			

($T_a = 25 \pm 2^\circ\text{C}$)

Note:

1. Contrast ratio will be measured in the center of panel (point 5 in Figure 2), Contrast Ratio (CR) is defined mathematically as:

$$\text{Contrast Ratio} = \frac{\text{Surface Luminance of } L_{\text{on5}}}{\text{Surface Luminance of } L_{\text{off5}}}$$

2. Surface luminance is luminance value at point 5 across the LCD surface 50cm from the surface with all pixels displaying white. From more information see FIG 2. When $V_{\text{DDB}} = 24\text{V}$, $I_{\text{DDB}} = 6.04\text{A}$. $L_{\text{WH}} = L_{\text{O51}}$. Where L_{on5} is the luminance with all pixels displaying white at center 5 location.
3. The variation in surface luminance, δ_{WHITE} is defined (center of Screen) as:

$$\delta_{\text{WHITE(9P)}} = \text{Maximum}(L_{\text{on1}}, L_{\text{on2}}, \dots, L_{\text{on9}}) / \text{Minimum}(L_{\text{on1}}, L_{\text{on2}}, \dots, L_{\text{on9}})$$
4. Response time T_{γ} is the average time required for display transition by switching the input signal for five luminance ratio (0%,25%,50%,75%,100% brightness matrix) and is based on $f_v = 60\text{Hz}$ to optimize.

	0%	25%	50%	75%	100%
0%		t:0%-25%	t:0%-50%	t:0%-75%	t:0%-100%
25%	t:25%-0%		t:25%-50%	t:25%-75%	t:25%-100%
50%	t:50%-0%	t:50%-25%		t:50%-75%	t:50%-100%
75%	t:75%-0%	t:75%-25%	t:75%-50%		t:50%-100%
100%	t:100%-0%	t:100%-25%	t:100%-50%	t:100%-75%	

5. Viewing angle is the angle at which the contrast ratio is greater than 10. The angles are determined for the horizontal or x axis and the vertical or y axis with respect to the z axis which is normal to the LCD surface. For more information see FIG4.

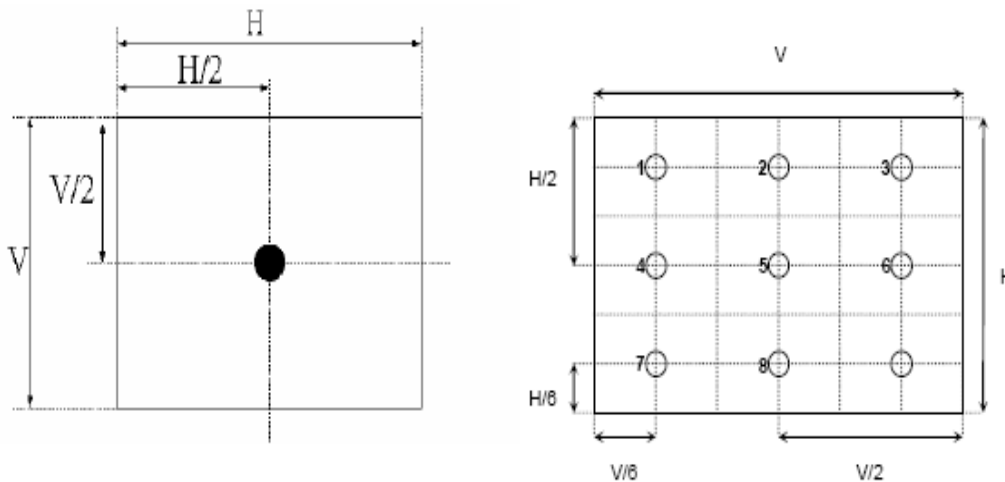

FIG. 2 Luminance measurement positions

The response time is defined as the following figure and shall be measured by switching the input signal for “any level of gray(bright) “ and “any level of gray(dark)”.

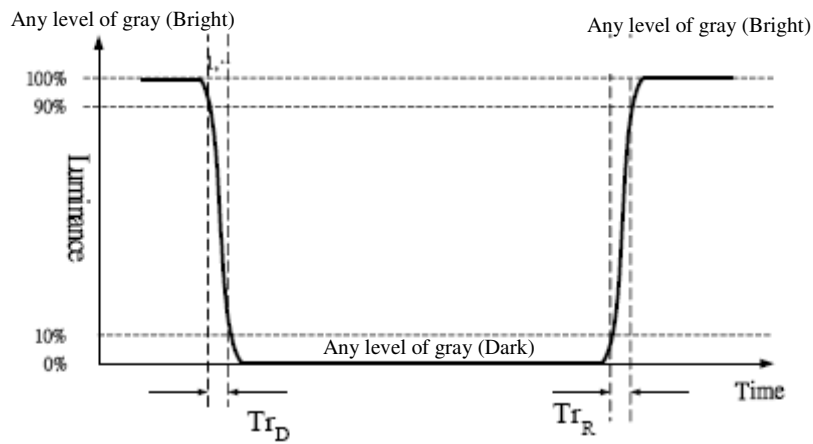

FIG.3 Measurement of Response Time

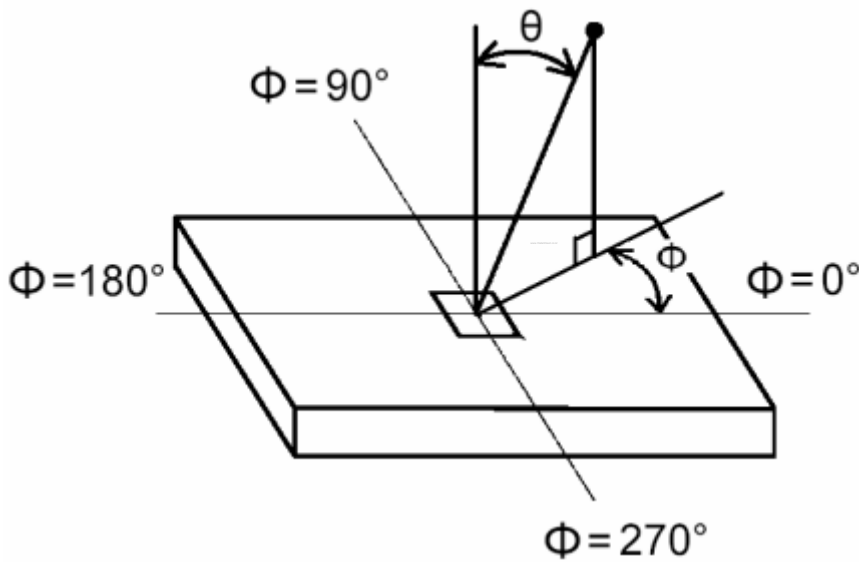

FIG.4 Measurement of viewing angle



5. Mechanical Characteristics

The contents provide general mechanical characteristics for the model T370HW02 V4. Detailed mechanical drawings are shown in the following pages.

Outline Dimension	Horizontal	877.0 mm
	Vertical	514.6mm
	Depth	54.3 mm(with inverter)
Bezel Opening	Horizontal	827.8 mm
	Vertical	469.4 mm
Active Display Area	Horizontal	819.36 mm
	Vertical	460.89 mm
Weight	10000g (Typ.)	

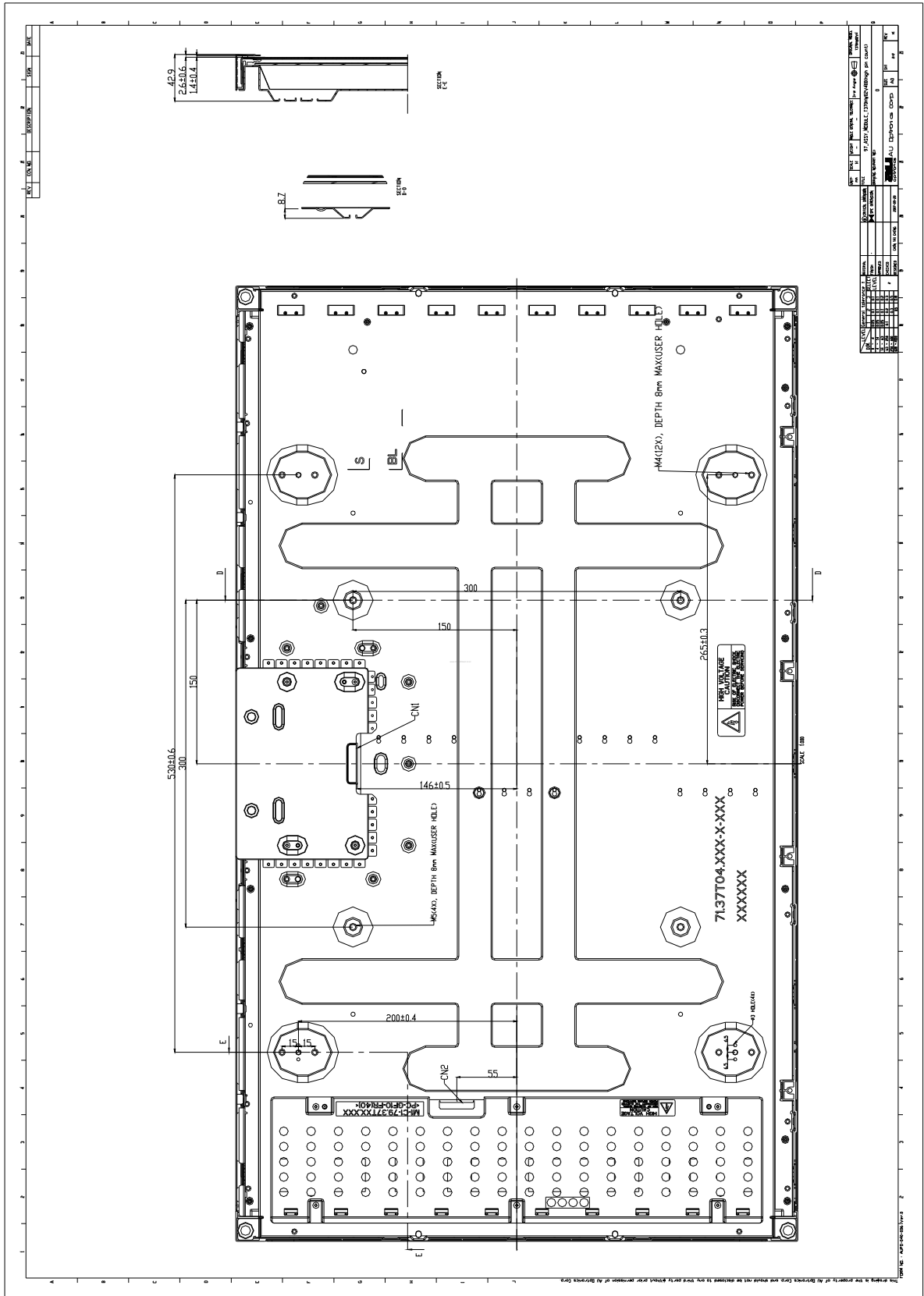



6. Reliability

Environment test condition:

	Test Items	Q'ty	Conditions
1	High Temperature Stroage	3	60°C 300 hrs
2	Low Temperature Stroage	3	-20°C, 300 hrs
3	High Temperature Operation	3	50°C, 300 hrs
4	Low Temperature Operation	3	-5°C, 300 hrs
5	Vibration (non-operation)	3	(10 ~ 300Hz/1.5G/11min SR, XYZ 30min/axis) Vibration level : 1.5G RMS, Bandwidth : 10-300Hz Duration: X, Y, Z 30min,
6	Shock (non-operation)	3	Shock level: 50G Waveform: have sine wave, 11ms Direction: $\pm X, \pm Y, \pm Z$ One time each direction
7	Vibration (With carton)	3	Random wave (1.5 Grms 10~200Hz) 30mins / Per each X.Y.Z axes
8	Drop (With carton)	3	Height: 38cm 1 corner, 3 edges, 6 surfaces (ASTMD4169-I)



7. International Standard

7-1 Safety

- (1) UL1950 Third Edition, Underwriters Laboratories, Inc. Jan. 28, 1995
Standard for Safety of Information Technology Equipment Including electrical Business Equipment.
- (2) CAN/CSA C22.2 No. 950-95/60950 Third Edition, Canadian Standards Association,
Standard for Safety of Information Technology Equipment Including Electrical Business Equipment.
- (3) EN60950: 1992+A2: 1993+A2: 1993+C3: 1995+A4: 1997+A11: 1997
IEC 950: 1991+A1: 1992+A2: 1993+C3: 1995+A4:1996
European Committee for Electrotechnical Standardization (CENELEC)
EUROPEAN STANDARD for Safety of Information Technology Equipment Including
Electrical Business Equipment.

7-2 EMC

- a) ANSI C63.4 “Methods of Measurement of Radio-Noise Emissions from Low-Voltage Electrical and Electrical Equipment in the Range of 9kHz to 40GHz. “American National standards Institute(ANSI), 1992
- b) C.I.S.P.R “Limits and Methods of Measurement of Radio Interface Characteristics of Information Technology Equipment.” International Special committee on Radio Interference.
- c) EN 55022 “Limits and Methods of Measurement of Radio Interface Characteristics of Information Technology Equipment.” European Committee for Electrotechnical Standardization. (CENELEC), 1998



8. Packing

A. Panel Label:



TW6562700014-ZMA00

TW: T: Taiwan, A/B: China

00014: Panel Serial Number

ZMA: AUO internal code

B. Carton Label:





PACKING METHODS:

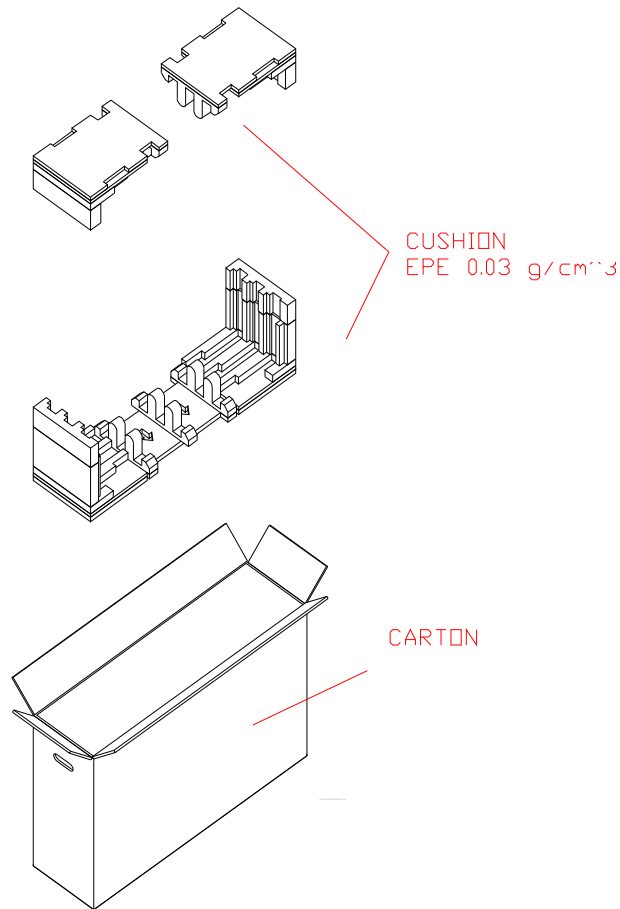

Packing Specification:

	Item	Specification			Packing Remark
		Qty.	Dimension	Weight (kg)	
1	Packing BOX	3 pcs/box	965(L)mm*280(W)mm*610(H)mm	30	
2	Pallet	1	1140(L)mm*980(W)mm*140(H)mm	15	
3	Boxes per Pallet	8 boxes/Pallet (By Air) ; 12 Boxes/Pallet (By Sea)			
4	Panels per Pallet	24pcs/pallet(By Air) ; 36 Boxes/Pallet (By Sea)			
	Pallet after packing	24 (by Air)	1140(L)mm*980(W)mm*1360(H)mm (by Air)	257 (by Air)	
		36(by Sea)	1140(L)mm*980(W)mm*2110(H)mm (by Sea)	393 (by Sea)	



9. PRECAUTIONS

Please pay attention to the followings when you use this TFT LCD module.

9-1 MOUNTING PRECAUTIONS

- (1) You must mount a module using holes arranged in four corners or four sides.
- (2) You should consider the mounting structure so that uneven force (ex. Twisted stress) is not applied to module. And the case on which a module is mounted should have sufficient strength so that external force is not transmitted directly to the module.
- (3) Please attach the surface transparent protective plate to the surface in order to protect the polarizer. Transparent protective plate should have sufficient strength in order to resist external force.
- (4) You should adopt radiation structure to satisfy the temperature specification.
- (5) Acetic acid type and chlorine type materials for the cover case are not desirable because the former generates corrosive gas of attacking the polarizer at high temperature and the latter causes circuit break by electro-chemical reaction.
- (6) Do not touch, push or rub the exposed polarizer with glass, tweezers or anything harder than HB pencil lead. And please do not rub with dust clothes with chemical treatment. Do not touch the surface of polarizer for bare hand or greasy cloth. (Some cosmetics are detrimental to the polarizer.)
- (7) When the surface becomes dusty, please wipe gently with absorbent cotton or other soft materials like chamois soaks with petroleum benzene. Normal-hexane is recommended for cleaning the adhesives used to attach front/ rear polarizer. Do not use acetone, toluene and alcohol because they cause chemical damage to the polarizer.
- (8) Wipe off saliva or water drops as soon as possible. Their long time contact with polarizer causes deformations and color fading.
- (9) Do not open the case because inside circuits do not have sufficient strength.

9-2 OPERATING PRECAUTIONS

- (1) The device listed in the product specification sheets was designed and manufactured for TV application
- (2) The spike noise causes the mis-operation of circuits. It should be lower than following voltage: $V = \pm 200\text{mV}$ (Over and under shoot voltage)
- (3) Response time depends on the temperature. (In lower temperature, it becomes longer.)
- (4) Brightness of CCFL depends on the temperature. (In lower temperature, it becomes lower.) And in lower temperature, response time (required time that brightness is stable after turned on) becomes longer.
- (5) Be careful for condensation at sudden temperature change. Condensation makes damage to polarizer or electrical contacted parts. And after fading condensation, smear or spot will occur.
- (6) When fixed patterns are displayed for a long time, remnant image is likely to occur.
- (7) Module has high frequency circuits. Sufficient suppression to the electromagnetic interference shall be done by system manufacturers. Grounding and shielding methods may be important to minimize the interface.



9-3 ELECTROSTATIC DISCHARGE CONTROL

Since a module is composed of electronic circuits, it is not strong to electrostatic discharge. Make certain that treatment persons are connected to ground through wristband etc. And don't touch interface pin directly.

9-4 PRECAUTIONS FOR STRONG LIGHT EXPOSURE

Strong light exposure causes degradation of polarizer and color filter.

9-5 STORAGE

When storing modules as spares for a long time, the following precautions are necessary.

- (1) Store them in a dark place. Do not expose the module to sunlight or fluorescent light. Keep the temperature between 5°C and 35°C at normal humidity.
- (2) The polarizer surface should not come in contact with any other object. It is recommended that they be stored in the container in which they were shipped.

9-6 HANDLING PRECAUTIONS FOR PROTECTION FILM

- (1) The protection film is attached to the bezel with a small masking tape. When the protection film is peeled off, static electricity is generated between the film and polarizer. This should be peeled off slowly and carefully by people who are electrically grounded and with well ion-blown equipment or in such a condition, etc.
- (2) When the module with protection film attached is stored for a long time, sometimes there remains a very small amount of flue still on the Bezel after the protection film is peeled off.
- (3) You can remove the glue easily. When the glue remains on the Bezel or its vestige is recognized, please wipe them off with absorbent cotton waste or other soft material like chamois soaked with normal-hexane.