



MIC38150

HELDO[®] 1.5A High Efficiency Low Dropout Regulator

General Description

The MIC38150 is a 1.5A continuous output current step down converter. This is a follow on product in the new HELDO[®] (High Efficiency Low DropOut Regulators) family, that provide the benefits of an LDO with respect to ease of use, fast transient performance, high PSRR and low noise while offering the efficiency of a switching regulator.

As output voltages move lower, the output noise and transient response of a switching regulator become an increasing challenge for designers. By combining a switcher whose output is slaved to the input of a high performance LDO, high efficiency is achieved with a clean low noise output. The MIC38150 is designed to provide less than 5mV of peak-to-peak noise and over 70dB of PSRR at 1kHz. Furthermore, the architecture of the MIC38150 is optimized for fast load transients allowing the output to maintain less than 30mV of output voltage deviation even during ultra fast load steps. This makes the MIC38150 an ideal choice for low voltage ASICs and other digital ICs.

The MIC38150 features a fully integrated switching regulator and LDO combination, operates with input voltages from 3.0V to 5.5V input and offers adjustable output voltages down to 1.0V.

The MIC38150 is offered in the small 28-pin 4mm × 6mm × 0.9mm MFL[®] package and can operate from -40°C to +125°C.

Data sheets and support documentation can be found on Micrel's web site at: www.micrel.com



HELDO[®]

Features

- Output current up to 1.5A
- Input voltage range: 3.0V to 5.5V
- Adjustable output voltage down to 1.0V
- Output noise less than 5mV
- Ultra fast transient performance
- Unique switcher plus LDO architecture
- Fully integrated MOSFET switches
- Micro-power shutdown
- Easy upgrade from LDO as power dissipation becomes an issue
- Thermal shutdown and current limit protection
- 4mm × 6mm × 0.9mm MFL[®] package

Applications

- Point-of-load applications
- Networking, server, industrial power
- Wireless base-stations
- Sensitive RF applications

Typical Application

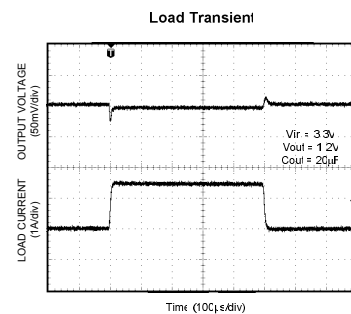
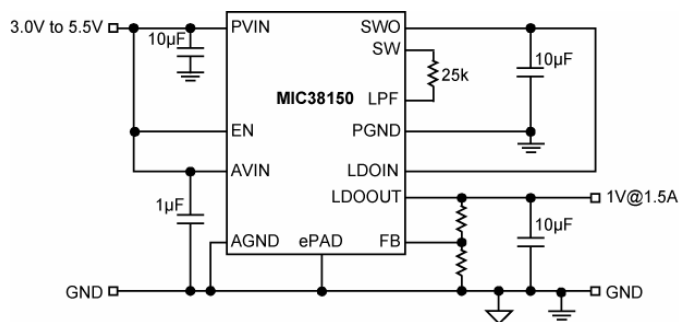

HELDO is a registered trademark of Micrel, Inc.
MLF and MicroLeadFrame are registered trademark of Amkor Technologies

Micrel Inc. • 2180 Fortune Drive • San Jose, CA 95131 • USA • tel +1 (408) 944-0800 • fax + 1 (408) 474-1000 • <http://www.micrel.com>

Ordering Information

Part Number	Output Current	Voltage ⁽¹⁾	Junction Temperature Range	Package
MIC38150HYHL	1.5A	ADJ	-40°C to +125°C	PB-Free 28-Pin 4x6 MLF [®]

Note: For additional voltage options, contact Micrel.

Pin Configuration

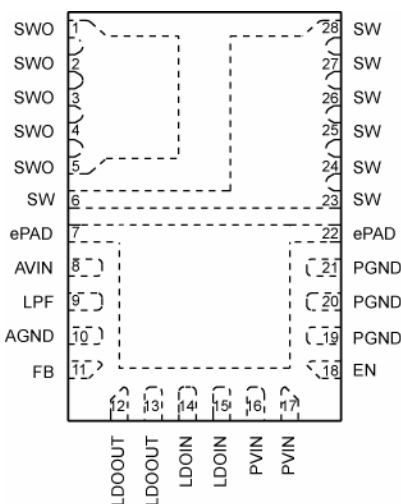

**28-Pin 4mm x 6mm MLF[®] (ML)
(Top View)**

Pin Description

Pin Number	Pin Name	Pin Name
1, 2, 3, 4, 5	SWO	Switch (Output): This is the output of the PFM Switcher.
6, 23, 24, 25, 26, 27, 28	SW	Switch Node: Attach external resistor from LPF to increase hysteretic frequency.
7, 22	ePAD	Exposed heat-sink pad. Connect externally to PGND.
8	AVIN	Analog Supply Voltage: Supply for the analog control circuitry. Requires bypass capacitor to ground. Nominal bypass capacitor is 1 μ F.
9	LPF	Low Pass Filter: Attach external resistor from SW to increase hysteretic frequency.
10	AGND	Analog Ground.
11	FB	Feedback: Input to the error amplifier. Connect to the external resistor divider network to set the output voltage.
12, 13	LDOOUT	LDO Output: Output of voltage regulator. Place capacitor to ground to bypass the output voltage. Nominal bypass capacitor is 10 μ F.
14, 15	LDOIN	LDO Input: Connect to SW output. Requires a bypass capacitor to ground. Nominal bypass capacitor is 10 μ F.
16, 17	PVIN	Input Supply Voltage (Input): Requires bypass capacitor to GND. Nominal bypass capacitor is 10 μ F.
18	EN	Enable (Input): Logic low will shut down the device, reducing the quiescent current to less than 50 μ A. This pin can also be used as an under-voltage lockout function by connecting a resistor divider from EN pin-to-VIN and GND. It should be not left open.
19, 20, 21	PGND	Power Ground.

Absolute Maximum Ratings⁽¹⁾

Supply Voltage (V_{IN})	6V
Output Switch Voltage (V_{SW})	6V
Logic Input Voltage (V_{EN})	-0.3V to V_{IN}
Power Dissipation	Internally Limited ⁽³⁾
Storage Temperature (T_S)	$-65^{\circ}\text{C} \leq T_J \leq +150^{\circ}\text{C}$
Lead Temperature (soldering, 10sec)	260°C
ESD Rating ⁽⁴⁾	1.5kV

Operating Ratings⁽²⁾

Supply voltage (V_{IN})	3.0V to 5.5V
Enable Input Voltage (V_{EN})	0V to V_{IN}
Junction Temperature Range	$-40^{\circ}\text{C} \leq T_J \leq +125^{\circ}\text{C}$
Package Thermal Resistance	
4mm × 6mm MLF-28 (θ_{JA})	24°C/W

Electrical Characteristics⁽⁵⁾

$T_A = 25^{\circ}\text{C}$ with $V_{IN} = V_{EN} = 5\text{V}$; $I_{OUT} = 10\text{mA}$, $V_{OUT} = 1.8\text{V}$. **Bold** values indicate $-40^{\circ}\text{C} \leq T_J \leq +125^{\circ}\text{C}$, unless noted.

Parameter	Conditions	Min	Typ	Max	Units
Supply Voltage Range		3.0		5.5	V
Under-Voltage Lockout Threshold	Turn-on		2.85		V
UVLO Hysteresis			100		mV
Quiescent Current	$I_{OUT} = 0\text{A}$, Not switching, Open Loop		1		mA
Turn-on Time	V_{OUT} to 95% of nominal		200	500	μs
Shutdown Current	$V_{EN} = 0\text{V}$		30	50	μA
Feedback Voltage	$\pm 2.5\%$	0.975	1	1.025	V
Feedback Current			5		nA
Dropout Voltage ($V_{IN} - V_{OUT}$)	$I_{LOAD} = 1.5\text{A}$; $V_{OUT} = 3\text{V}$		0.85	1.2	V
Current Limit	$V_{FB} = 0.9 \times V_{NOM}$	1.75	3		A
Output Voltage Load Regulation	$V_{OUT} = 1.8\text{V}$, 10mA to 1.5A		0.1	1	%
Output Voltage Line Regulation	$V_{OUT} = 1.8\text{V}$, V_{IN} from 3.0V to 5.5V		0.35	0.5	%/V
Output Ripple	$I_{LOAD} = 1.5\text{A}$, $C_{OUTLDO} = 20\mu\text{F}$, $C_{OUTSW} = 20\mu\text{F}$ LPF=25k Ω		2		mV
Over-Temperature Shutdown			150		$^{\circ}\text{C}$
Over-Temperature Shutdown Hysteresis			15		$^{\circ}\text{C}$
Enable Input⁽⁶⁾					
Enable Input Threshold	Regulator enable	0.90	1	1.1	V
Enable Hysteresis		20	100	200	mV
Enable Input Current			0.03	1	μA

Notes:

- Exceeding the absolute maximum rating may damage the device.
- The device is not guaranteed to function outside its operating rating.
- The maximum allowable power dissipation of any T_A (ambient temperature) is $P_{D(max)} = (T_{J(max)} - T_A) / \theta_{JA}$. Exceeding the maximum allowable power dissipation will result in excessive die temperature, and the regulator will go into thermal shutdown.
- Devices are ESD sensitive. Handling precautions recommended. Human body model, 1.5k in series with 100pF.
- Specification for packaged product only.
- Enable pin should not be left open.

Typical Characteristics

$V_{IN} = 3.3V$, $V_{OUT} = 1.8V$, $C_{OUT} = 10\mu F$, $R_{LPF} = 25k\Omega$, $I_{OUT} = 100mA$, unless noted

MIC38150 PSRR

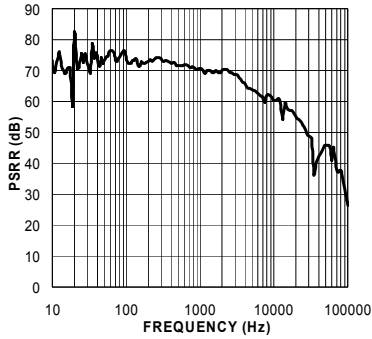

Load Regulation

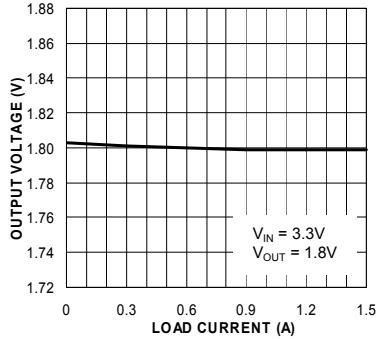

Output Voltage vs. Input Voltage

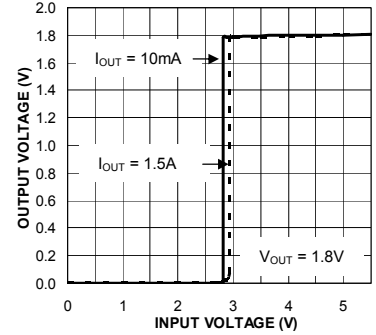

Output Voltage vs. Temperature

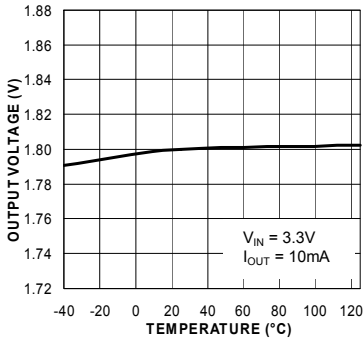

Thermal Shutdown

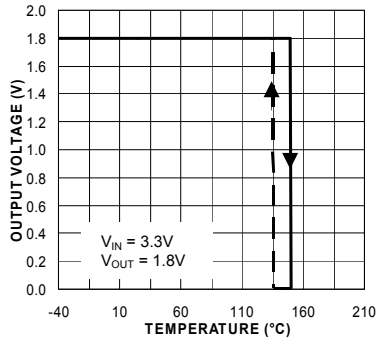

MIC38150 Efficiency

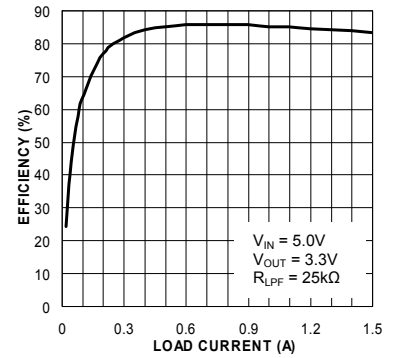

Dropout Voltage vs. Load Current

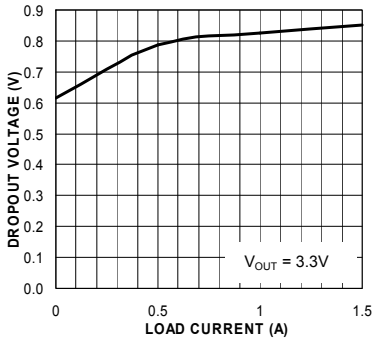

Dropout Voltage vs. Temperature

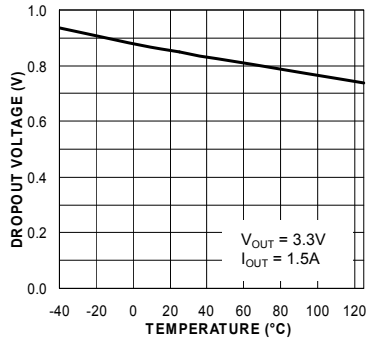

Current Limit vs. Input Voltage

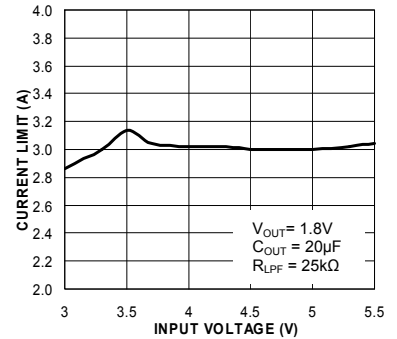

Enable Threshold

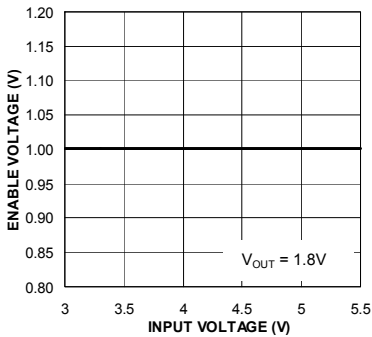

Operating Current vs. Input Voltage

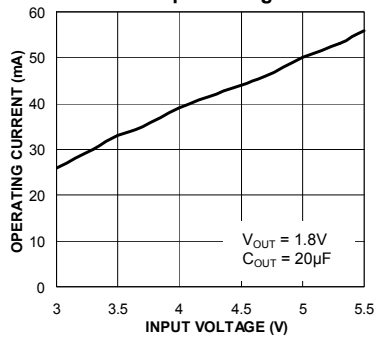

Typical Characteristics

$V_{IN} = 3.3V$, $V_{OUT} = 1.8V$, $C_{OUT} = 10\mu F$, $R_{LPF} = 25k\Omega$, $I_{OUT} = 100mA$, unless noted

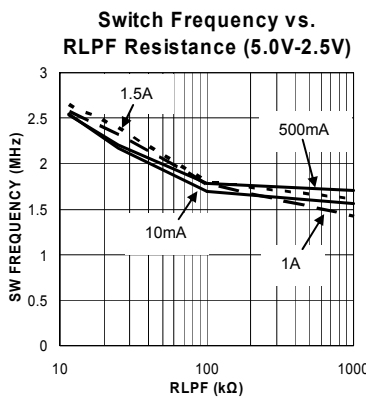
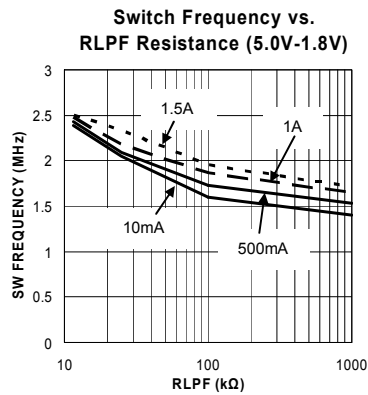
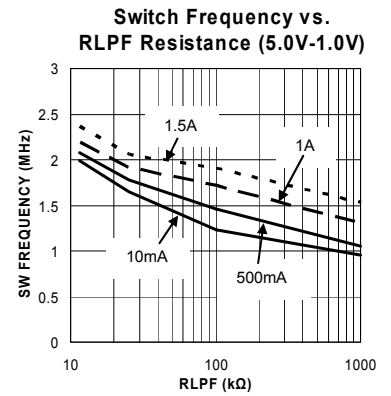
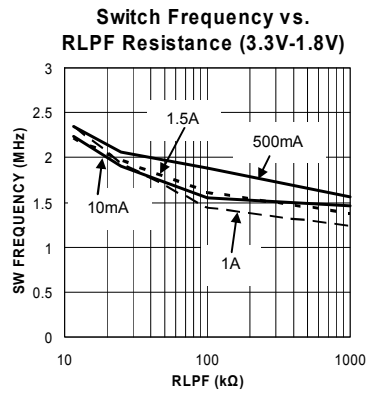
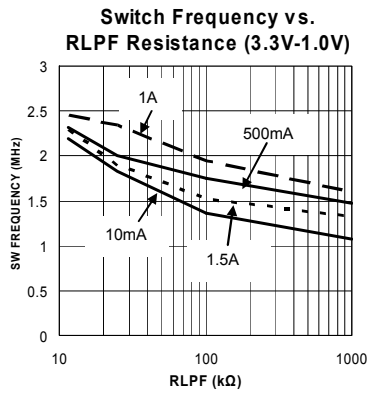

Functional Characteristics

$V_{IN} = 3.3V$, $V_{OUT} = 1.8V$, $C_{OUT} = 10\mu F$, Inductor = 470nH; $R_{L_{PF}} = 25k\Omega$, $I_{OUT} = 100mA$, unless noted

Enable Turn-On

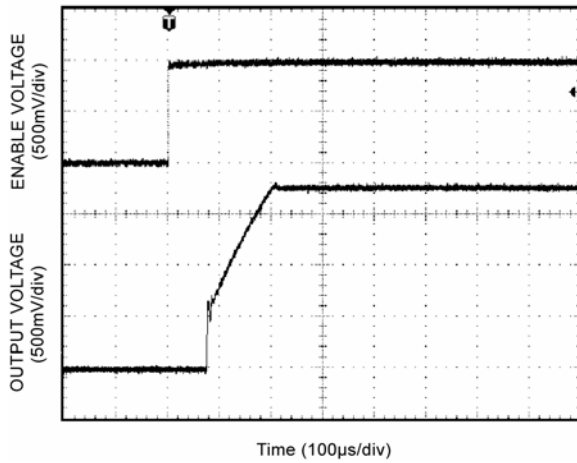

Line Transient

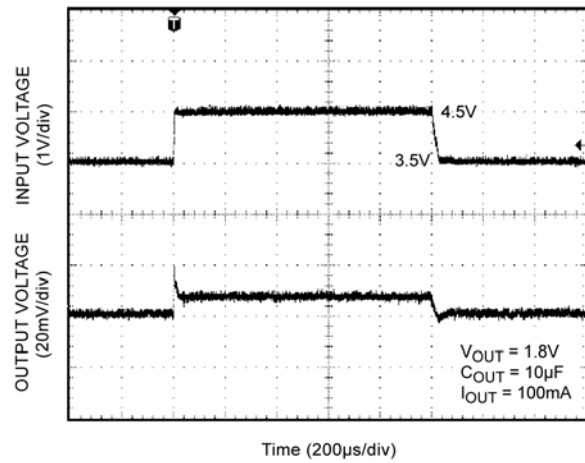

Load Transient

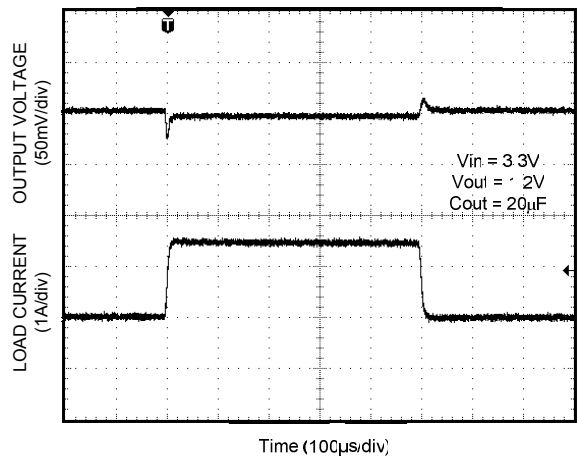

Output Ripple

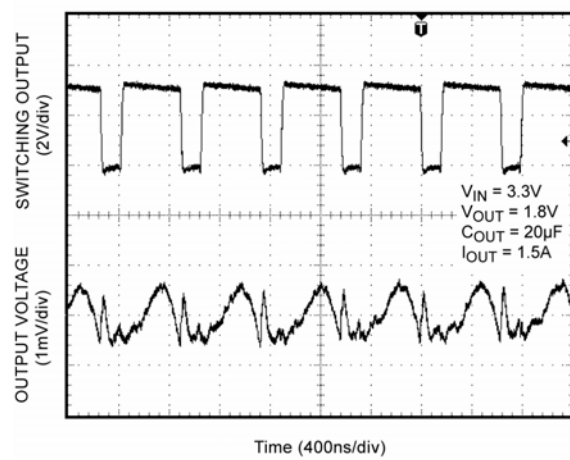

EMI Performance

$V_{OUT} = 1.8V$, $I_{OUT} = 1.2A$

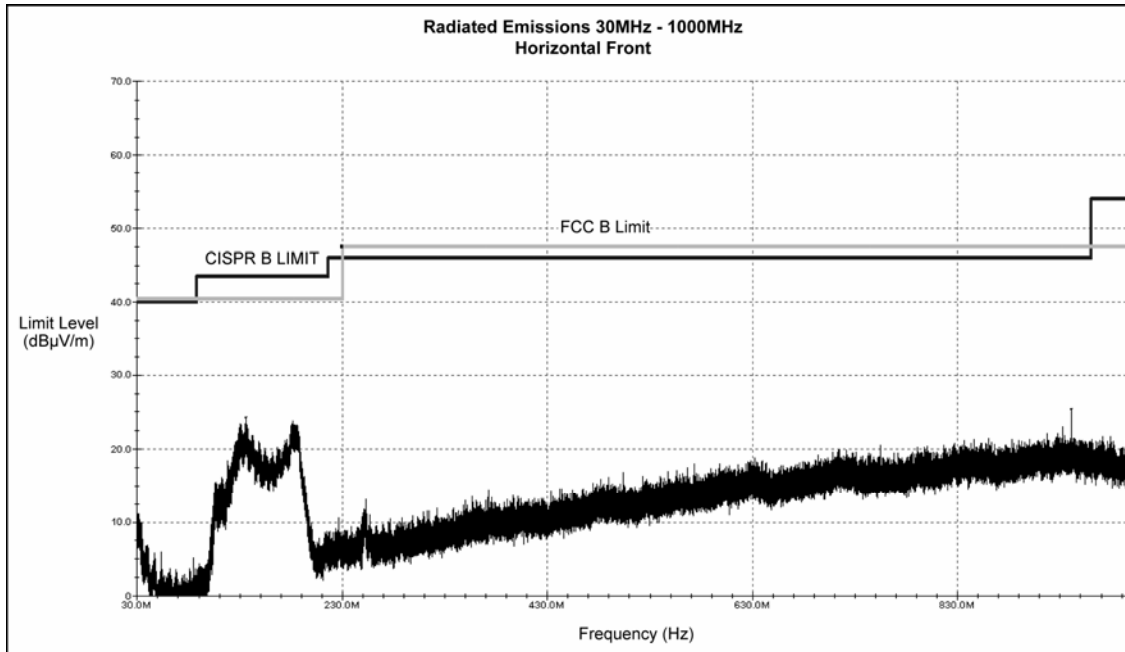

EMI Test – Horizontal Front

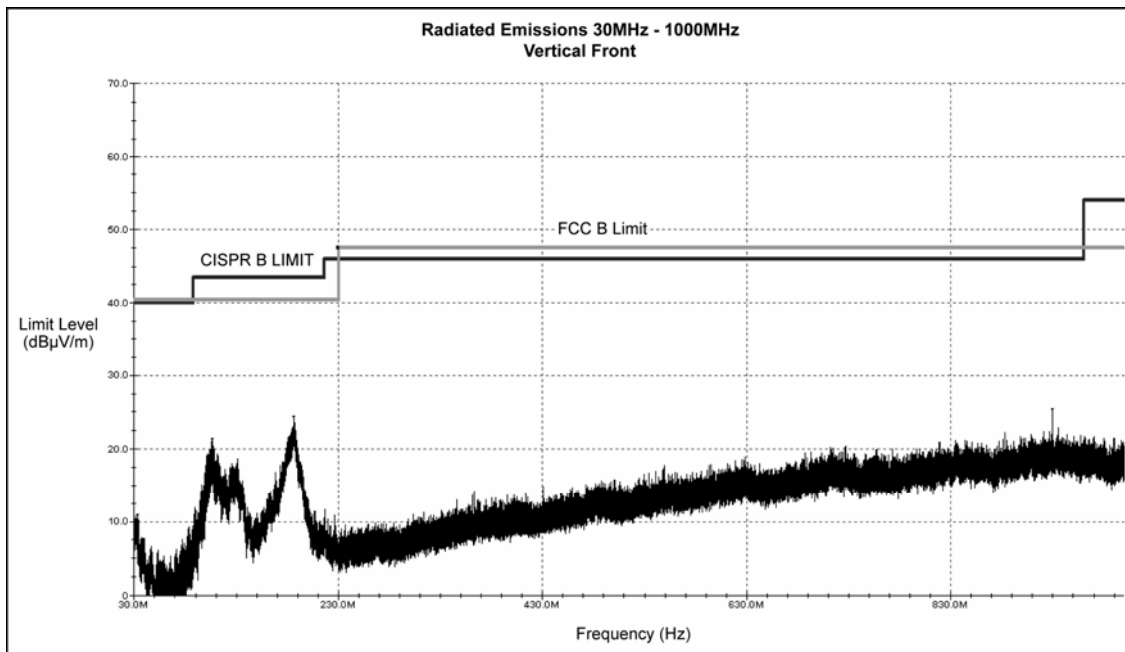

EMI Test – Vertical Front

Additional components to MIC38150 Evaluation Board:

1. Input Ferrite Bead Inductor. Part number: BLM21AG102SN1D
2. 0.1 μ F and 0.01 μ F ceramic bypass capacitors on PVIN, SW, SWO, and LDOOUT pins.

Block Diagram

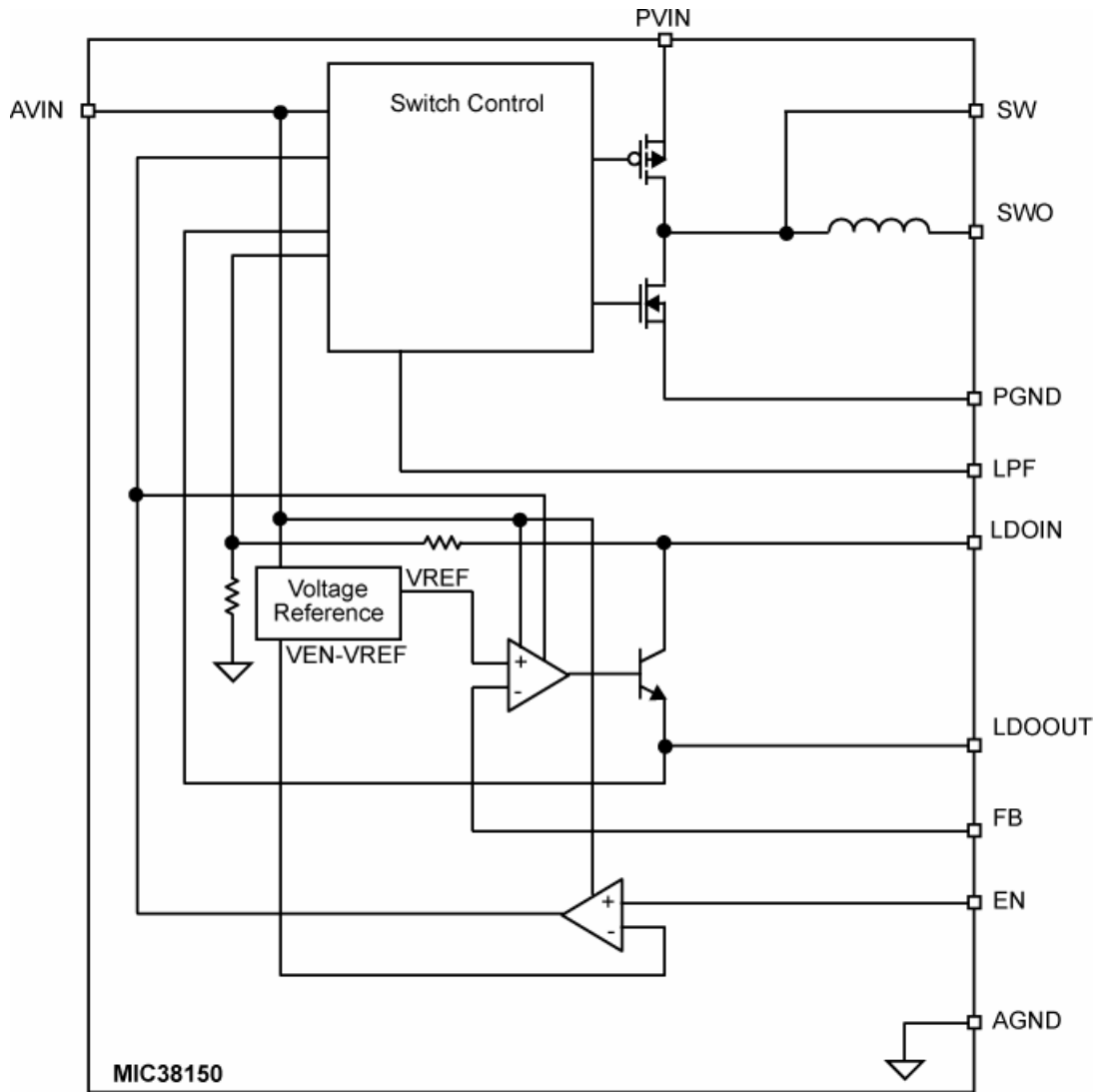

Application Information

Enable Input

The MIC38150 features a TTL/CMOS compatible positive logic enable input for on/off control of the device. High enables the regulator while low disables the regulator. In shutdown the regulator consumes very little current (only a few microamperes of leakage). For simple applications the enable (EN) can be connected to V_{IN} (IN).

Input Capacitor

PV_{IN} provides power to the MOSFETs for the switch mode regulator section and the gate drivers. Due to the high switching speeds, a $10\mu\text{F}$ capacitor is recommended close to PV_{IN} and the power ground ($PGND$) pin for bypassing.

Analog V_{IN} (AV_{IN}) provides power to the analog supply circuitry. AV_{IN} and PV_{IN} must be tied together externally. Careful layout should be considered to ensure high frequency switching noise caused by PV_{IN} is reduced before reaching AV_{IN} . A $1\mu\text{F}$ capacitor as close to AV_{IN} as possible is recommended.

Output Capacitor

The MIC38150 requires an output capacitor for stable operation. As a μCap LDO, the MIC38150 can operate with ceramic output capacitors of $10\mu\text{F}$ or greater. Values of greater than $10\mu\text{F}$ improve transient response and noise reduction at high frequency. X7R/X5R dielectric-type ceramic capacitors are recommended because of their superior temperature performance. X7R-type capacitors change capacitance by 15% over their operating temperature range and are the most stable type of ceramic capacitors. Larger output capacitances can be achieved by placing tantalum or aluminum electrolytics in parallel with the ceramic capacitor. For example, a $100\mu\text{F}$ electrolytic in parallel with a $10\mu\text{F}$ ceramic can provide the transient and high frequency noise performance of a $100\mu\text{F}$ ceramic at a significantly lower cost. Specific undershoot/overshoot performance will depend on both the values and ESR/ESL of the capacitors.

For less than 5mV noise performance at higher current loads, $20\mu\text{F}$ capacitors are recommended at LDO_{IN} and LDO_{OUT} .

Low Pass Filter Pin

The MIC38150 features a Low Pass Filter (LPF) pin for adjusting the switcher frequency. By tuning the frequency, the user can further improve output ripple. Adjusting the frequency is accomplished by connecting a resistor between the LPF and SW pins. A small value resistor would increase the frequency while a larger value resistor decreases the frequency. Recommended R_{LPF} value is $25\text{k}\Omega$.

Adjustable Regulator Design

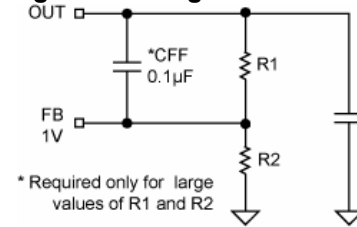

Adjustable Regulator with Resistors

The adjustable MIC38150 output voltage can be programmed from 1V to 5.0V using a resistor divider from output to the FB pin. Resistors can be quite large, up to $100\text{k}\Omega$ because of the very high input impedance and low bias current of the sense amplifier. For large value resistors ($>50\text{k}\Omega$), $R1$ should be bypassed by a small capacitor ($C_{FF} = 0.1\mu\text{F}$ bypass capacitor) to avoid instability due to phase lag at the ADJ/SNS input.

The output resistor divider values are calculated by:

$$V_{OUT} = 1V \times \left(\frac{R1}{R2} + 1 \right)$$

Efficiency Considerations

Efficiency is defined as the amount of useful output power, divided by the amount of power supplied.

$$\text{Efficiency}(\%) = \frac{V_{OUT} \times I_{OUT}}{V_{IN} \times I_{IN}} \times 100$$

Maintaining high efficiency serves two purposes. It reduces power dissipation in the power supply, reducing the need for heat sinks and thermal design considerations and it reduces consumption of current for battery powered applications. Reduced current draw from a battery increases the devices operating time and is critical in hand held devices.

There are two types of losses in switching converters; DC losses and switching losses. DC losses are simply the power dissipation of I^2R . Power is dissipated in the high side switch during the on cycle. Power loss is equal to the high side MOSFET $R_{DS(on)}$ multiplied by the Switch Current². During the off cycle, the low side N-channel MOSFET conducts, also dissipating power. Device operating current also reduces efficiency. The product of the quiescent (operating) current and the supply voltage is another DC loss.

Over 100mA, efficiency loss is dominated by MOSFET $R_{DS(on)}$ and inductor losses. Higher input supply voltages will increase the Gate to Source threshold on the internal MOSFETs, reducing the internal $R_{DS(on)}$. This improves efficiency by reducing DC losses in the device. As the inductors are reduced in size, the inductor losses are mainly caused by the DC resistance (DCR).

The DCR losses can be calculated as follows:

$$L_P_D = I_{OUT}^2 \times \text{DCR}$$

Efficiency loss due to DCR is minimal at light loads and gains significance as the load is increased.

PCB Layout Guideline

Warning!!! To minimize EMI and output noise, follow these layout recommendations.

PCB Layout is critical to achieve reliable, stable and efficient performance. A ground plane is required to control EMI and minimize the inductance in power, signal and return paths.

The following guidelines should be followed to insure proper operation of the MIC38150.

IC

- Place the IC close to the point of load (POL).
- Use fat traces to route the input and output power lines.
- The exposed pad (ePAD) on the bottom of the IC must be connected to the PGND pins of the IC.
- Use several vias to connect the ePAD to the ground plane.
- Signal and power grounds should be kept separate and connected at only one location.
- Keep the switch node (SW) away from the feedback (FB) pin.

Input Capacitor

- Place the input capacitor next.
- Place the input capacitors on the same side of the board and as close to the MIC38150 as possible.
- Keep both the PVIN and PGND connections short.
- Place several vias to the ground plane close to the input capacitor ground terminal, but not between the

input capacitors and IC pins.

- Use either X7R or X5R dielectric input capacitors. Do not use Y5V or Z5U type capacitors.
- Do not replace the ceramic input capacitor with any other type of capacitor. Any type of capacitor can be placed in parallel with the input capacitor.
- If a Tantalum input capacitor is placed in parallel with the input capacitor, it must be recommended for switching regulator applications and the operating voltage must be derated by 50%.
- In “Hot-Plug” applications, a Tantalum or Electrolytic bypass capacitor must be used to limit the over-voltage spike seen on the input supply with power is suddenly applied.
- The 1 μ F capacitor, which connects to the AVIN terminal, must be located right at the IC. The AVIN terminal is very noise sensitive and placement of the capacitor is very critical. Connections must be made with wide trace.

Output Capacitor

- Use a wide trace to connect the VSW output capacitor ground terminal to the PVIN input capacitor ground terminal.
- The feedback trace should be separate from the power trace and connected as close as possible to the output capacitor.

Evaluation Board Schematics

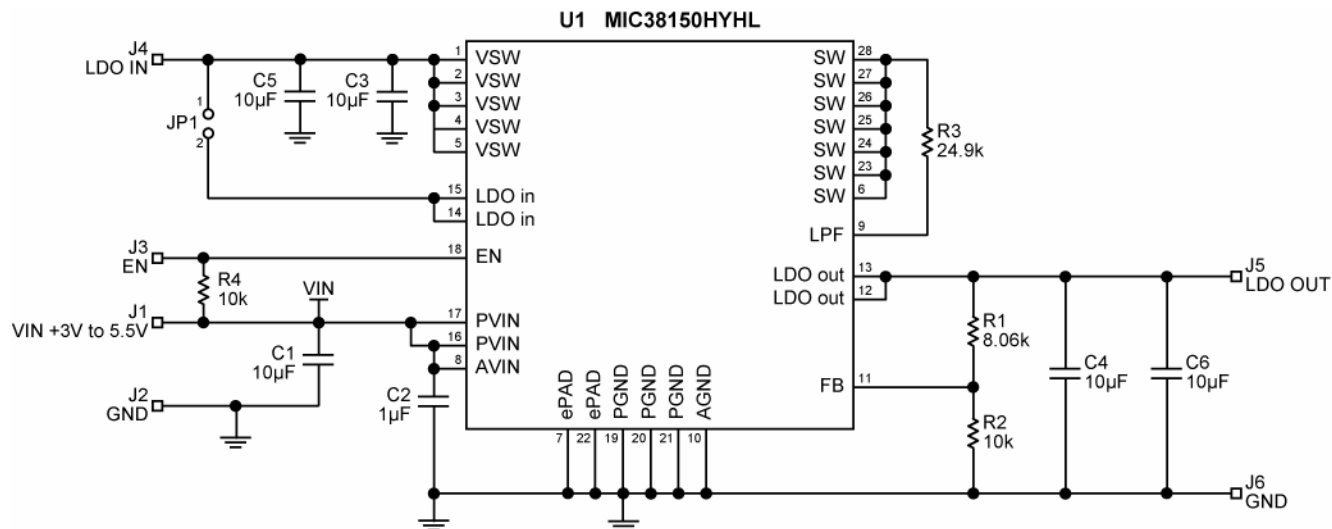

Bill of Materials

Item	Part Number	Manufacturer	Description	Qty
C1, C3, C4, C5, C6	0805ZD106MAT2A	AVX ⁽¹⁾	10uF, 10V, X5R, 0805 Ceramic Capacitor	5
	LMK212BJ106KG-T	Taiyo Yuden ⁽²⁾		
	C2012X5R1A106K	TDK ⁽³⁾		
	GRM219R61A106KE44D	Murata ⁽⁴⁾		
C2	C2012X5R1A105K	TDK ⁽³⁾	1uF, 10V, X5R, 0805 Ceramic Capacitor	1
	0805ZD105KAT2A	AVX ⁽¹⁾		
	GRM219R61A105MA01D	Murata ⁽⁴⁾		
R1	CRCW06038061FRT1	Vishay ⁽⁵⁾	8.06k, 1%, 1/10W, 0603	1
R2, R4	CRCW06031002KEYE3	Vishay ⁽⁵⁾	10k, 1%, 1/10W, 0603	2
R3	CRCW06032492FRT1	Vishay ⁽⁵⁾	24.9k, 1%, 1/10W, 0603	1
U1	MIC38150-HYHL	Micrel, Inc. ⁽⁶⁾	HELDO [®] 1.5A High Efficiency Low Dropout Regulator	1

Notes:

1. AVX: www.avx.com
2. Taiyo Yuden: www.t-yuden.com
3. TDK: www.tdk.com
4. Murata: www.murata.com
5. Vishay: www.vishay.com
6. Micrel, Inc.: www.micrel.com

PCB Layout

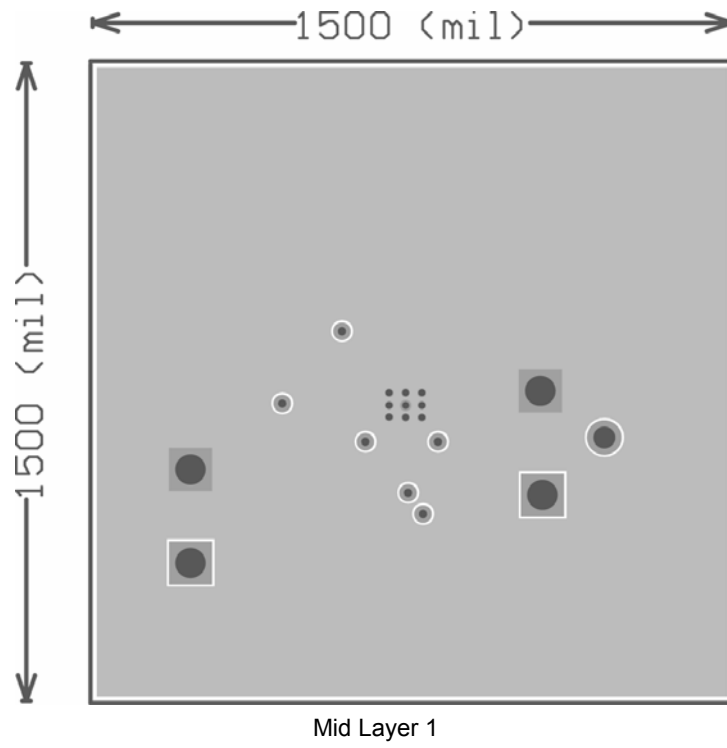
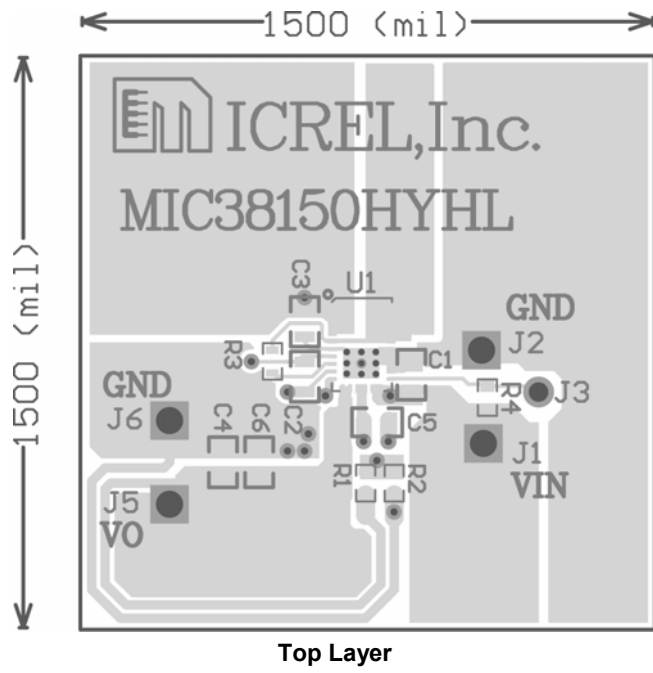

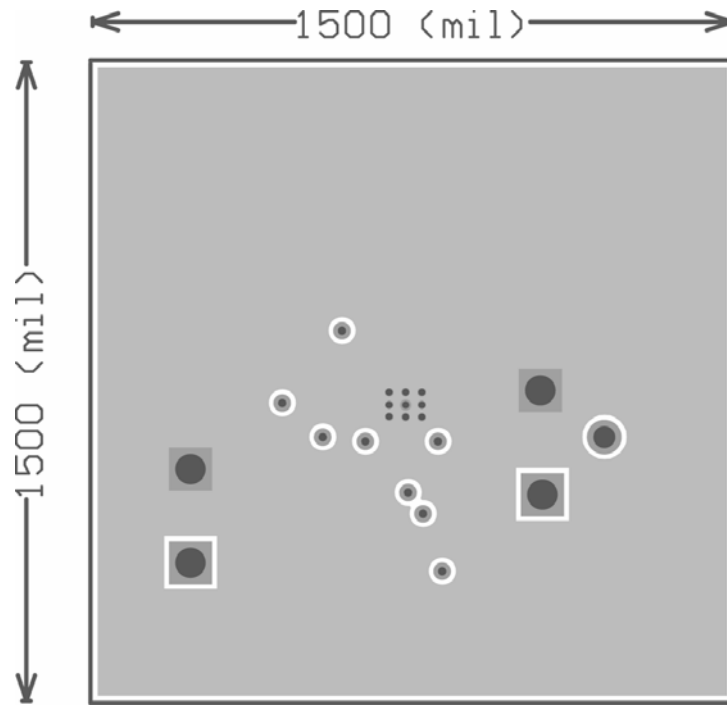

Mid Layer 2

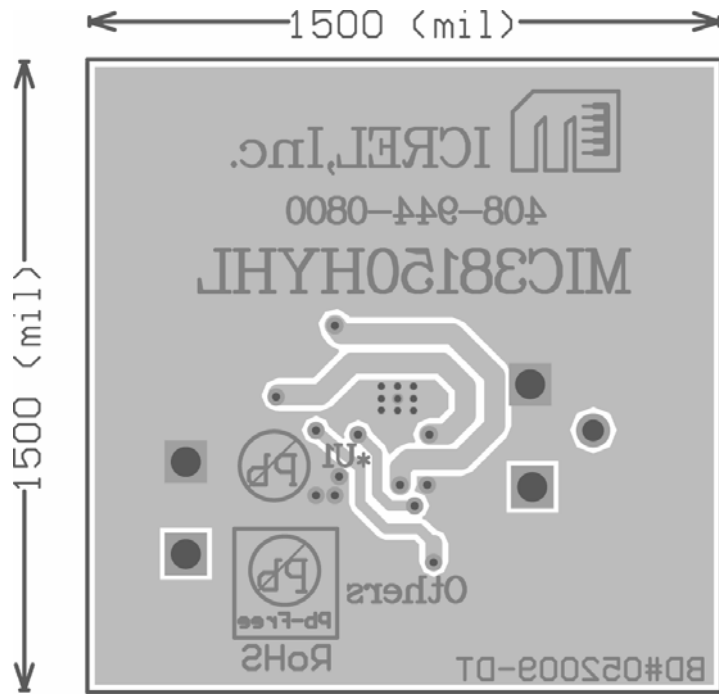

Bottom Layer

Package Information

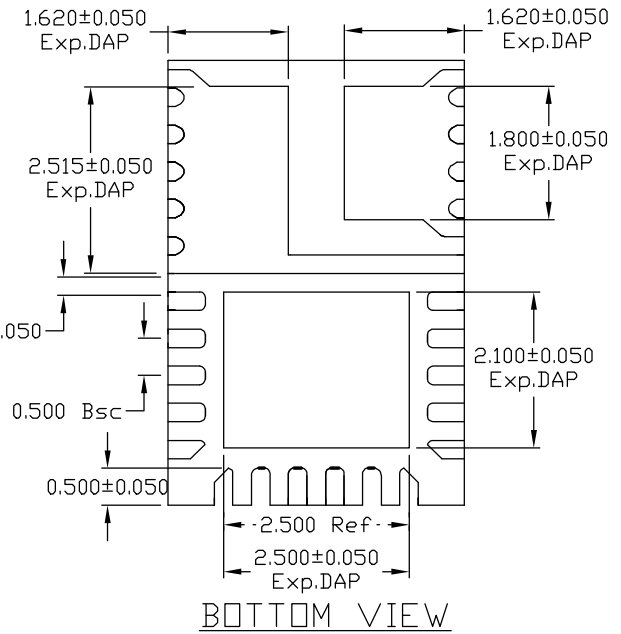
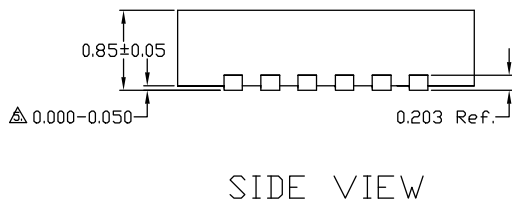
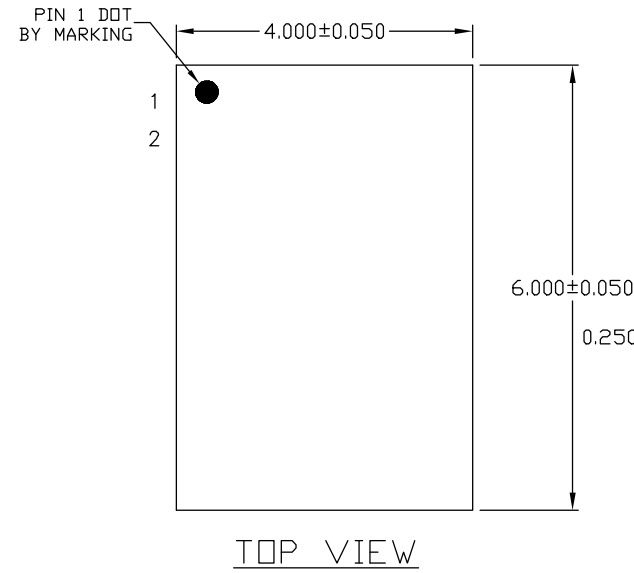

- NOTE:
1. ALL DIMENSIONS ARE IN MILLIMETERS.
 2. MAX. PACKAGE WARPAGE IS 0.05 mm.
 3. MAXIMUM ALLOWABLE BURRS IS 0.075 mm IN ALL DIRECTIONS.
 4. PIN #1 ID ON TOP WILL BE LASER/INK MARKED.
- △ APPLIED ONLY FOR TERMINALS.

28-Pin 4mm x 6mm MLF® (ML)

Recommended Landing Pattern

LP # HMLF46T-28LD-LP-1
 All units are in mm
 Tolerance ± 0.05 if not noted

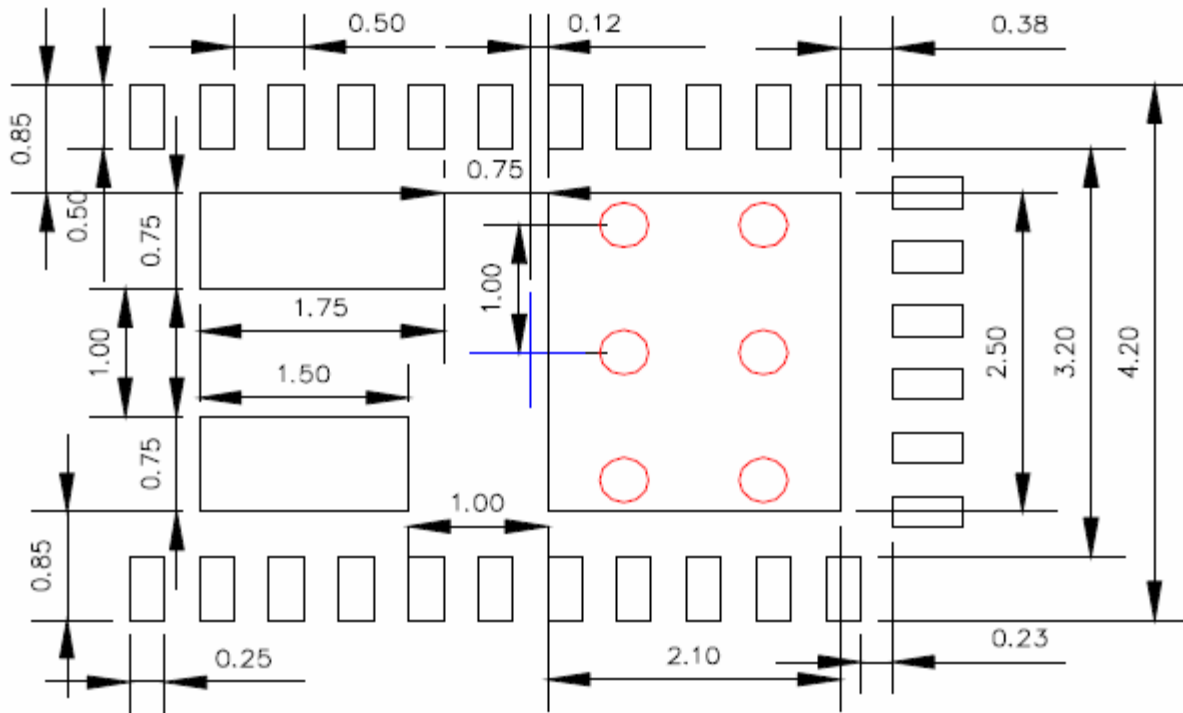

Red circle indicates Thermal Via. Size should be .300-.350 mm in diameter and it should be connected to GND plane for maximum thermal performance.

MICREL, INC. 2180 FORTUNE DRIVE SAN JOSE, CA 95131 USA
 TEL +1 (408) 944-0800 FAX +1 (408) 474-1000 WEB <http://www.micrel.com>

The information furnished by Micrel in this data sheet is believed to be accurate and reliable. However, no responsibility is assumed by Micrel for its use. Micrel reserves the right to change circuitry and specifications at any time without notification to the customer.

Micrel Products are not designed or authorized for use as components in life support appliances, devices or systems where malfunction of a product can reasonably be expected to result in personal injury. Life support devices or systems are devices or systems that (a) are intended for surgical implant into the body or (b) support or sustain life, and whose failure to perform can be reasonably expected to result in a significant injury to the user. A Purchaser's use or sale of Micrel Products for use in life support appliances, devices or systems is a Purchaser's own risk and Purchaser agrees to fully indemnify Micrel for any damages resulting from such use or sale.

© 2009 Micrel, Incorporated.