

PLEASE CHECK WWW.MOLEX.COM FOR LATEST PART INFORMATION

Part Number: [0459854253](#)
Status: **Active**
Overview: [extreme_lphpower](#)
Description: 1.27mm (.050"), 12.00mm (.472") Pitch, EXTreme LPHPower™ Header, Right Angle, 4 Power Contacts, 28 Signal Contacts, Select Gold (Au) Plating, for 1.57mm (.062") Thick PC Board, with Guide Pockets

Documents:

[3D Model](#) [Product Specification PS-45984-001 \(PDF\)](#)
[Drawing \(PDF\)](#) [RoHS Certificate of Compliance \(PDF\)](#)



Agency Certification

CSA	LR19980
TUV	30683046
UL	E29179

General

Product Family	PCB Headers
Series	45985
Application	Board-to-Board
Overview	extreme_lphpower
Product Name	EXTreme LPHPower™

Physical

Breakaway	No
Circuits (Loaded)	32
Circuits (maximum)	32
Circuits Detail	4 Power, 28 Signal
Color - Resin	Black
Durability (mating cycles max)	250
First Mate / Last Break	Yes
Flammability	94V-0
Glow-Wire Compliant	No
Guide to Mating Part	Yes
Keying to Mating Part	None
Lock to Mating Part	No
Material - Metal	Brass, High Performance Alloy (HPA)
Material - Plating Mating	Gold
Material - Plating Termination	Tin
Material - Resin	High Temperature Thermoplastic
Number of Rows	2
Orientation	Right Angle
PC Tail Length (in)	0.114 In
PC Tail Length (mm)	2.90 mm
PCB Locator	No
PCB Retention	None
PCB Thickness Recommended (in)	0.062 In
PCB Thickness Recommended (mm)	1.57 mm
Packaging Type	Tray
Pitch - Mating Interface (in)	0.050 In, 0.472 In
Pitch - Mating Interface (mm)	1.27 mm, 12.00 mm
Plating min: Mating (µin)	30
Plating min: Mating (µm)	0.75
Plating min: Termination (µin)	150, 50
Plating min: Termination (µm)	1.25, 3.75
Polarized to Mating Part	Yes

EU RoHS
ELV and RoHS
Compliant
REACH SVHC
 Not Reviewed
Halogen-Free
Status
Not Reviewed

China RoHS



Need more information on product environmental compliance?

Email productcompliance@molex.com
 For a multiple part number RoHS Certificate of Compliance, [click here](#)

Please visit the [Contact Us](#) section for any non-product compliance questions.

Search Parts in this Series

[45985Series](#)

Mates With

[45984](#) EXTreme LPHPower™ PCB Receptacles

Polarized to PCB	Yes
Shrouded	Fully
Stackable	No
Surface Mount Compatible (SMC)	Yes
Temperature Range - Operating	-40°C to +105°C
Termination Interface: Style	Through Hole

Electrical

Current - Maximum per Contact	30A
Voltage - Maximum	250V AC (RMS)/DC

Solder Process Data

Duration at Max. Process Temperature (seconds)	20
Lead-free Process Capability	Wave Capable (TH only)
Max. Cycles at Max. Process Temperature	3
Process Temperature max. C	260

Material Info

Reference - Drawing Numbers

Packaging Specification	PK-45984-001
Product Specification	PS-45984-001
Sales Drawing	SD-45985-400

This document was generated on 05/25/2010

PLEASE CHECK WWW.MOLEX.COM FOR LATEST PART INFORMATION



- NOTES:
1. MATERIAL: LCP, 94V-0, BLACK
POWER CONTACT: COPPER ALLOY
SIGNAL CONTACT: PHOSPHOR BRONZE
 2. FINISH: SELECT GOLD 0.76µM/30 MI MIN. IN CONTACT AREA
SELECT TIN 3.81µM/150 MI MIN. IN PC TAIL AREA
BOTH OVER NICKEL 1.27µM/50 MI MIN
 3. PRODUCT SPECIFICATION: PS-45984-001
 4. PACKAGING SPECIFICATION: TRAY PER PK-45984-001.
 5. SEE SHEET 5 FOR CIRCUIT IDENTIFICATION.
 6. PARTS ARE RoHS COMPLIANT.
 7. PEG HOLES ARE OPTIONAL PCB FEATURES AND ARE REQUIRED ONLY WITH THE PEGGED OPTIONS.
 8. MATES WITH MOLEX RECEPTACLE SERIES 45984-4***.



NO OF SIGNAL	MATERIAL NUMBER	DIM A REF	DIM P	PCB THK
12	45985-4111	36.16	4.50	3.18
16	45985-4121	38.70		
20	45985-4131	41.24		
24	45985-4141	43.78		
28	45985-4151	46.32		
32	45985-4161	48.86		
36	45985-4171	51.40	3.90	2.36
40	45985-4181	53.94		
12	45985-4112	36.16		
16	45985-4122	38.70		
20	45985-4132	41.24		
24	45985-4142	43.78		
28	45985-4152	46.32	2.90	1.57
32	45985-4162	48.86		
36	45985-4172	51.40		
40	45985-4182	53.94		
12	45985-4113	36.16		
16	45985-4123	38.70		
20	45985-4133	41.24	2.90	1.57
24	45985-4143	43.78		
28	45985-4153	46.32		
32	45985-4163	48.86		
36	45985-4173	51.40		
40	45985-4183	53.94		



45985-4161
(SHOWN FOR REFERENCE)
SEE CHART

REVISED	DESCRIPTION
EC NO: UCP2007-3140	
DRWN:MBANDURA	2008/03/03
CHKD:	2008/03/04
APPR:APATEL	2008/03/06
C	REV

GENERAL TOLERANCES (UNLESS SPECIFIED)	
	mm INCH
4 PLACES	± --- ± ---
3 PLACES	± --- ± ---
2 PLACES	± 0.25 ± ---
1 PLACE	± --- ± ---
ANGULAR ±1/2°	
DRAFT WHERE APPLICABLE MUST REMAIN WITHIN DIMENSIONS	

DIMENSION STYLE	
MM ONLY	
DRAWN BY	DATE
JSCHAFFER	6-10-05
CHECKED BY	DATE
YMARGUL IS	6-14-05
APPROVED BY	DATE
YMARGUL IS	6-15-05
MATERIAL NO.	
SEE CHART	
SIZE	
A	

SCALE	DESIGN UNITS	THIRD ANGLE PROJECTION	
1:1	METRIC		
TITLE			
LPH PLUG ASSEMBLY RT ANGLE 4 CIRCUIT POWER CONNECTOR			
MOLEX INCORPORATED			
DOCUMENT NO.			SHEET NO.
SD-45985-400			1 OF 5
THIS DRAWING CONTAINS INFORMATION THAT IS PROPRIETARY TO MOLEX INCORPORATED AND SHOULD NOT BE USED WITHOUT WRITTEN PERMISSION			

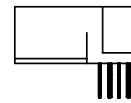
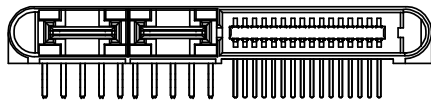
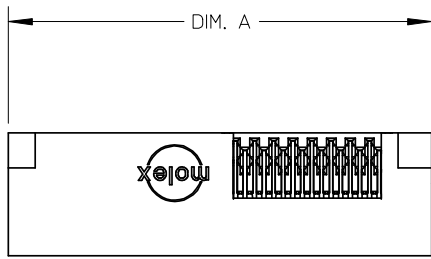

GUIDE OPTIONS

NO OF SIGNAL	MATERIAL NUMBER	DIM A REF	DIM P	PCB THK
12	45985-4211	43.66	4.50	3.18
16	45985-4221	46.20		
20	45985-4231	48.74		
24	45985-4241	51.28		
28	45985-4251	53.82		
32	45985-4261	56.36		
36	45985-4271	58.90	3.90	2.36
40	45985-4281	61.44		
12	45985-4212	43.66		
16	45985-4222	46.20		
20	45985-4232	48.74		
24	45985-4242	51.28		
28	45985-4252	53.82	2.90	1.57
32	45985-4262	56.36		
36	45985-4272	58.90		
40	45985-4282	61.44		
12	45985-4213	43.66		
16	45985-4223	46.20		
20	45985-4233	48.74	2.90	1.57
24	45985-4243	51.28		
28	45985-4253	53.82		
32	45985-4263	56.36		
36	45985-4273	58.90		
40	45985-4283	61.44		

NOTE:
1. SEE SHEET 1 FOR DIMENSIONS NOT SHOWN.



45985-4261
(SHOWN FOR REFERENCE)
SEE CHART

REVISED EC NO: UCP2007-3140 DRWN:MBANDURA 2008/03/03 CHKD: 2008/03/04 APPR:APATEL 2008/03/06 DESCRIPTION REV	GENERAL TOLERANCES (UNLESS SPECIFIED)		DIMENSION STYLE MM ONLY		SCALE 1:1	DESIGN UNITS METRIC	THIRD ANGLE PROJECTION
		mm	INCH	DRAWN BY JSCHAFFER	DATE 6-10-05	TITLE LPH PLUG ASSEMBLY RT ANGLE 4 CIRCUIT POWER CONNECTOR	
	4 PLACES	± ---	± ---	CHECKED BY YMARGUL IS	DATE 6-14-05		
	3 PLACES	± ---	± ---	APPROVED BY YMARGUL IS	DATE 6-15-05	MOLEX INCORPORATED	
	2 PLACES	± 0.25	± ---	MATERIAL NO. SEE CHART		DOCUMENT NO. SD-45985-400	SHEET NO. 2 OF 5
	1 PLACE	± ---	± ---	THIS DRAWING CONTAINS INFORMATION THAT IS PROPRIETARY TO MOLEX INCORPORATED AND SHOULD NOT BE USED WITHOUT WRITTEN PERMISSION			
ANGULAR ±1/2°		DRAFT WHERE APPLICABLE MUST REMAIN WITHIN DIMENSIONS					



MOUNTING PEG OPTIONS

NO OF SIGNAL	MATERIAL NUMBER	DIM A REF	DIM C	DIM P	PCB THK
12	45985-4311	43.66	37.98	4.50	3.18
16	45985-4321	46.20	40.52		
20	45985-4331	48.74	43.06		
24	45985-4341	51.28	45.60		
28	45985-4351	53.82	48.14		
32	45985-4361	56.36	50.68		
36	45985-4371	58.90	53.22	3.90	2.36
40	45985-4381	61.44	55.76		
12	45985-4312	43.66	37.98		
16	45985-4322	46.20	40.52		
20	45985-4332	48.74	43.06		
24	45985-4342	51.28	45.60		
28	45985-4352	53.82	48.14		
32	45985-4362	56.36	50.68		
36	45985-4372	58.90	53.22		
40	45985-4382	61.44	55.76	2.90	1.57
12	45985-4313	43.66	37.98		
16	45985-4323	46.20	40.52		
20	45985-4333	48.74	43.06		
24	45985-4343	51.28	45.60		
28	45985-4353	53.82	48.14		
32	45985-4363	56.36	50.68		
36	45985-4373	58.90	53.22		
40	45985-4383	61.44	55.76		

NOTE:
1. SEE SHEET 1 FOR DIMENSIONS NOT SHOWN.

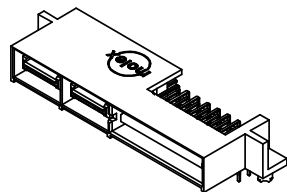

45985-4361
(SHOWN FOR REFERENCE)
SEE CHART

REVISED EC NO: UCP2007-3140 DRWN:MBANDURA 2008/03/03 CHKD: 2008/03/04 APPR:APATEL 2008/03/06 DESCRIPTION REV	GENERAL TOLERANCES (UNLESS SPECIFIED)		DIMENSION STYLE MM ONLY		SCALE 1:1	DESIGN UNITS METRIC	THIRD ANGLE PROJECTION		
		mm	INCH	DRAWN BY JSCHAFFER	DATE 6-10-05	TITLE LPH PLUG ASSEMBLY RT ANGLE 4 CIRCUIT POWER CONNECTOR			
	4 PLACES	± ---	± ---	CHECKED BY YMARGULIS	DATE 6-14-05				
	3 PLACES	± ---	± ---	APPROVED BY YMARGULIS	DATE 6-15-05	MOLEX INCORPORATED			
2 PLACES	± 0.25	± ---	MATERIAL NO. SEE CHART		DOCUMENT NO. SD-45985-400				
1 PLACE	± ---	± ---	ANGULAR ±1/2°		THIS DRAWING CONTAINS INFORMATION THAT IS PROPRIETARY TO MOLEX INCORPORATED AND SHOULD NOT BE USED WITHOUT WRITTEN PERMISSION				
DRAFT WHERE APPLICABLE MUST REMAIN WITHIN DIMENSIONS			SIZE A						

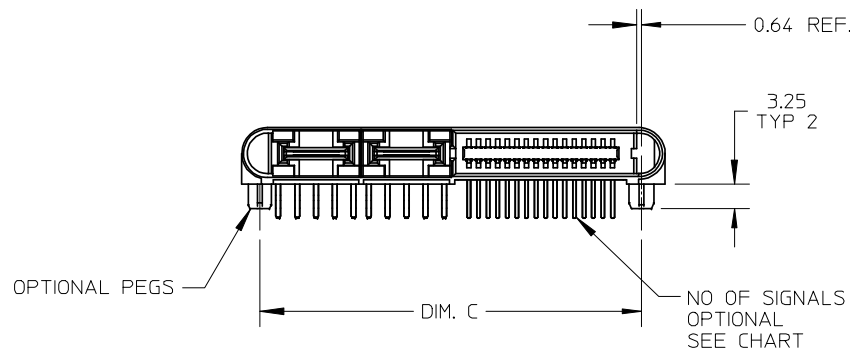

GUIDE & MOUNTING PEG OPTIONS

NO OF SIGNAL	MATERIAL NUMBER	DIM A REF	DIM C	DIM P	PCB THK
12	45985-4411	43.66	37.98	4.50	3.18
16	45985-4421	46.20	40.52		
20	45985-4431	48.74	43.06		
24	45985-4441	51.28	45.60		
28	45985-4451	53.82	48.14		
32	45985-4461	56.36	50.68		
36	45985-4471	58.90	53.22	3.90	2.36
40	45985-4481	61.44	55.76		
12	45985-4412	43.66	37.98		
16	45985-4422	46.20	40.52		
20	45985-4432	48.74	43.06		
24	45985-4442	51.28	45.60		
28	45985-4452	53.82	48.14		
32	45985-4462	56.36	50.68		
36	45985-4472	58.90	53.22	2.90	1.57
40	45985-4482	61.44	55.76		
12	45985-4413	43.66	37.98		
16	45985-4423	46.20	40.52		
20	45985-4433	48.74	43.06		
24	45985-4443	51.28	45.60		
28	45985-4453	53.82	48.14		
32	45985-4463	56.36	50.68		
36	45985-4473	58.90	53.22		
40	45985-4483	61.44	55.76		

NOTE:
1. SEE SHEET 1 FOR DIMENSIONS NOT SHOWN.

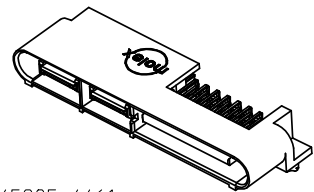

45985-4461
(SHOWN FOR REFERENCE)
SEE CHART

REVISED	DESCRIPTION
EC NO: UCP2007-3140	
DRWN:MBANDURA	2008/03/03
CHKD:	2008/03/04
APPR:APATEL	2008/03/06
REV	

GENERAL TOLERANCES (UNLESS SPECIFIED)	
	mm INCH
4 PLACES	± --- ± ---
3 PLACES	± --- ± ---
2 PLACES	± 0.25 ± ---
1 PLACE	± --- ± ---
ANGULAR ±1/2°	
DRAFT WHERE APPLICABLE MUST REMAIN WITHIN DIMENSIONS	

DIMENSION STYLE	
MM ONLY	
DRAWN BY	DATE
JSCHAFFER	6-10-05
CHECKED BY	DATE
YMARGULIS	6-14-05
APPROVED BY	DATE
YMARGULIS	6-15-05
MATERIAL NO.	
SEE CHART	
SIZE	
A	

SCALE	DESIGN UNITS	THIRD ANGLE PROJECTION
1:1	METRIC	
TITLE		
LPH PLUG ASSEMBLY RT ANGLE 4 CIRCUIT POWER CONNECTOR		
MOLEX INCORPORATED		
DOCUMENT NO.	SHEET NO.	
SD-45985-400	4 OF 5	

CIRCUIT NUMBERING SYSTEM

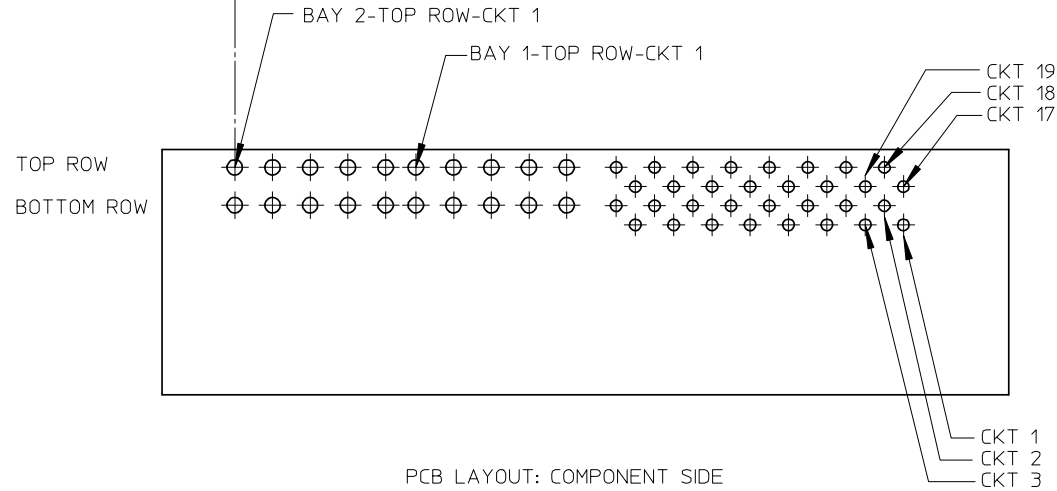
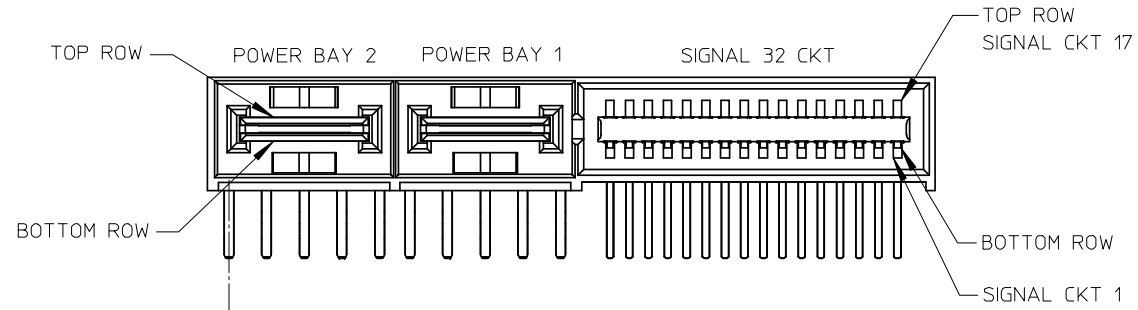

PCB LAYOUT: COMPONENT SIDE

REVISED EC NO: UCP2007-3140 DRWN:MBANDURA 2008/03/03 CHKD: 2008/03/04 APPR:APATEL 2008/03/06 DESCRIPTION REV	GENERAL TOLERANCES (UNLESS SPECIFIED)		DIMENSION STYLE MM ONLY		SCALE 2:1	DESIGN UNITS METRIC	THIRD ANGLE PROJECTION	
		mm	INCH	DRAWN BY JSCHAFFER	DATE 6-10-05	TITLE LPH PLUG ASSEMBLY RT ANGLE 4 CIRCUIT POWER CONNECTOR		
	4 PLACES	± ---	± ---	CHECKED BY YMARGUL IS	DATE 6-14-05			
	3 PLACES	± ---	± ---	APPROVED BY YMARGUL IS	DATE 6-15-05	MOLEX INCORPORATED DOCUMENT NO. SD-45985-400 SHEET NO. 5 OF 5		
	2 PLACES	± 0.25	± ---	MATERIAL NO. SEE CHART				
1 PLACE	± ---	± ---	DRAFT WHERE APPLICABLE MUST REMAIN WITHIN DIMENSIONS		THIS DRAWING CONTAINS INFORMATION THAT IS PROPRIETARY TO MOLEX INCORPORATED AND SHOULD NOT BE USED WITHOUT WRITTEN PERMISSION			