

EC4SM-24.000M

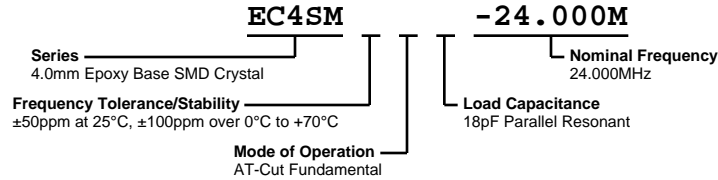

ELECTRICAL SPECIFICATIONS

Nominal Frequency	24.000MHz
Frequency Tolerance/Stability	±50ppm at 25°C, ±100ppm over 0°C to +70°C
Aging at 25°C	±5ppm/year Maximum
Load Capacitance	18pF Parallel Resonant
Shunt Capacitance (C0)	7pF Maximum
Equivalent Series Resistance	40 Ohms Maximum
Mode of Operation	AT-Cut Fundamental
Drive Level	1mWatts Maximum
Storage Temperature Range	-40°C to +85°C
Insulation Resistance	500 Megaohms Minimum at 100Vdc

ENVIRONMENTAL & MECHANICAL SPECIFICATIONS

Fine Leak Test	MIL-STD-883, Method 1014 Condition A
Gross Leak Test	MIL-STD-883, Method 1014 Condition C
Mechanical Shock	MIL-STD-202, Method 213 Condition C
Resistance to Soldering Heat	MIL-STD-202, Method 210
Resistance to Solvents	MIL-STD-202, Method 215
Solderability	MIL-STD-883, Method 2003
Temperature Cycling	MIL-STD-883, Method 1010
Vibration	MIL-STD-883, Method 2007 Condition A

MECHANICAL DIMENSIONS (all dimensions in millimeters)

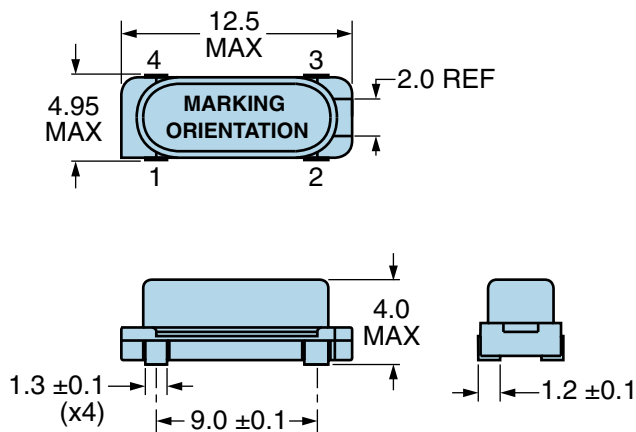

PIN	CONNECTION
1	Connected to Pin 4 and to Crystal
2	Connected to Pin 3 and to Crystal
3	Connected to Pin 2 and to Crystal
4	Connected to Pin 1 and to Crystal

LINE	MARKING
1	E24.000 E=Ecliptek Designator

EC4SM-24.000M

Suggested Solder Pad Layout

All Dimensions in Millimeters

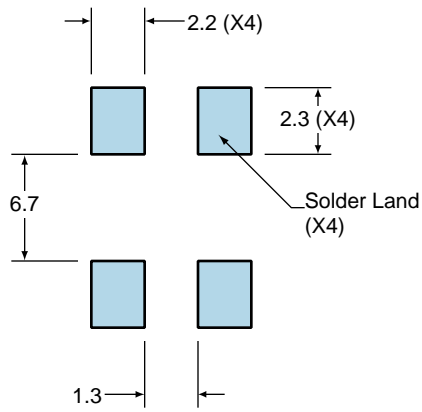

All Tolerances are ± 0.1

Recommended Solder Reflow Methods



Low Temperature Infrared/Convection 225°C

T_s MAX to T_L (Ramp-up Rate) 5°C/second Maximum

Preheat

- Temperature Minimum (T_s MIN) N/A
- Temperature Typical (T_s TYP) 150°C
- Temperature Maximum (T_s MAX) N/A
- Time (t_s MIN) 30 - 60 Seconds

Ramp-up Rate (T_L to T_p) 5°C/second Maximum

Time Maintained Above:

- Temperature (T_L) 150°C
- Time (t_L) 200 Seconds Maximum

Peak Temperature (T_p) 225°C Maximum

Target Peak Temperature (T_p Target) 225°C Maximum 2 Times

Time within 5°C of actual peak (t_p) 80 seconds Maximum 2 Times

Ramp-down Rate 5°C/second Maximum

Time 25°C to Peak Temperature (t) N/A

Moisture Sensitivity Level Level 1

Low Temperature Manual Soldering

185°C Maximum for 10 seconds Maximum, 2 times Maximum.

High Temperature Manual Soldering

260°C Maximum for 5 seconds Maximum, 2 times Maximum.