

**PLEASE CHECK WWW.MOLEX.COM FOR LATEST PART INFORMATION**

**Part Number:** [0459844443](#)  
**Status:** **Active**  
**Overview:** [extreme\\_lphpower](#)  
**Description:** 1.27mm (.050"), 12.00mm (.472") Pitch, EXTreme LPHPower™ Receptacle Header, Right Angle, 4 Power Contacts, 24 Signal Contacts, Select Gold (Au) Plating, for 1.57mm (.062") Thick PC Board, with Guide Posts, with Press-fit Plastic Pegs

**Documents:**

[3D Model](#) [Product Specification PS-45984-001 \(PDF\)](#)  
[Drawing \(PDF\)](#) [RoHS Certificate of Compliance \(PDF\)](#)

**Agency Certification**

CSA LR19980  
 UL E29179

**General**

Product Family PCB Receptacles  
 Series [45984](#)  
 Application Board-to-Board  
 Overview [extreme\\_lphpower](#)  
 Product Name EXTreme LPHPower™

**Physical**

Circuits (Loaded) 28  
 Circuits (maximum) 28  
 Circuits Detail 4 Power, 24 Signal  
 Color - Resin Black  
 Durability (mating cycles max) 250  
 Flammability 94V-0  
 Glow-Wire Compliant No  
 Guide to Mating Part Yes  
 Keying to Mating Part Yes  
 Lock to Mating Part No  
 Material - Metal High Performance Alloy (HPA), Phosphor Bronze  
 Material - Plating Mating Gold  
 Material - Plating Termination Tin  
 Material - Resin High Temperature Thermoplastic  
 Number of Rows 2  
 Orientation Right Angle  
 PC Tail Length (in) 0.114 In  
 PC Tail Length (mm) 2.90 mm  
 PCB Locator Yes  
 PCB Retention Yes  
 PCB Thickness Recommended (in) 0.062 In  
 PCB Thickness Recommended (mm) 1.57 mm  
 Packaging Type Tray  
 Pitch - Mating Interface (in) 0.050 In, 0.472 In  
 Pitch - Mating Interface (mm) 1.27 mm, 12.00 mm  
 Plating min: Mating (µin) 30  
 Plating min: Mating (µm) 0.75  
 Plating min: Termination (µin) 150, 75  
 Plating min: Termination (µm) 1.875, 3.75  
 Polarized to Mating Part Yes  
 Polarized to PCB Yes  
 Stackable No  
 Surface Mount Compatible (SMC) Yes

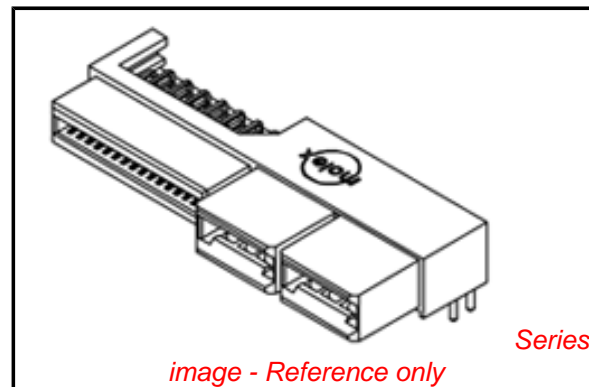

**EU RoHS**

**ELV and RoHS Compliant**  
**REACH SVHC Contains SVHC: No**  
**Halogen-Free Status**

**China RoHS**



**Halogen-Free**

**Need more information on product environmental compliance?**

Email [productcompliance@molex.com](mailto:productcompliance@molex.com)  
 For a multiple part number RoHS Certificate of Compliance, [click here](#)

Please visit the [Contact Us](#) section for any non-product compliance questions.

**Search Parts in this Series**

[45984Series](#)

**Mates With**

[45985](#) EXTreme LPHPower™ Headers, 1.57mm (.062") Card Edge

Temperature Range - Operating -40°C to +105°C  
Termination Interface: Style Through Hole

### **Electrical**

Current - Maximum per Contact 30A  
Grounding to PCB No  
Voltage - Maximum 250V AC (RMS)/DC

### **Solder Process Data**

Duration at Max. Process Temperature (seconds) 20  
Lead-free Process Capability Wave Capable (TH only)  
Max. Cycles at Max. Process Temperature 3  
Process Temperature max. C 260

### **Material Info**

#### **Reference - Drawing Numbers**

Packaging Specification PK-45984-001  
Product Specification PS-45984-001  
Sales Drawing SD-45984-400

This document was generated on 05/27/2010

**PLEASE CHECK [WWW.MOLEX.COM](http://WWW.MOLEX.COM) FOR LATEST PART INFORMATION**

6

5

4

3

2

1

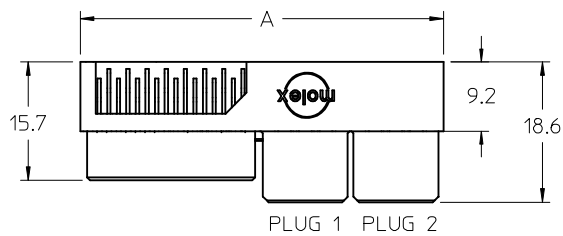

## NOTES:

1. MATERIAL HOUSING: LCP, 94V-0, COLOR-BLACK.  
CONTACT: COPPER ALLOY.
2. FINISH: SELECT GOLD - .76  $\mu\text{M}$ /30 MI MIN. CONTACT AREA.  
SELECT TIN - 3.81  $\mu\text{M}$ /150 MI MIN. TAIL AREA.  
BOTH OVER NICKEL - 1.27  $\mu\text{M}$ /50 MI MIN.
3. POWER TERMINALS ARE LUBRICATED IN CONTACT AREA.
3. PRODUCT SPECIFICATION: PS-45984-001.
4. PACKAGING: TRAY PER PK-45984-001.
5. SEE SHEET 5 FOR CKT IDENTIFICATION.
6. PARTS ARE RoHS COMPLIANT.
7. PEG HOLES ARE OPTIONAL SEE SHEET 3 AND 4.
8. MATES TO 1577.062 CARD EDGE OR MOLEX P/N 45985-4\*\*\*.

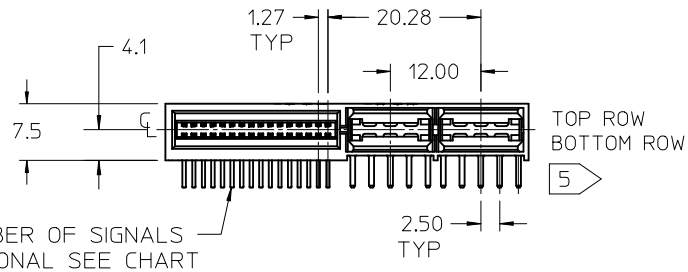

NUMBER OF SIGNALS  
OPTIONAL SEE CHART

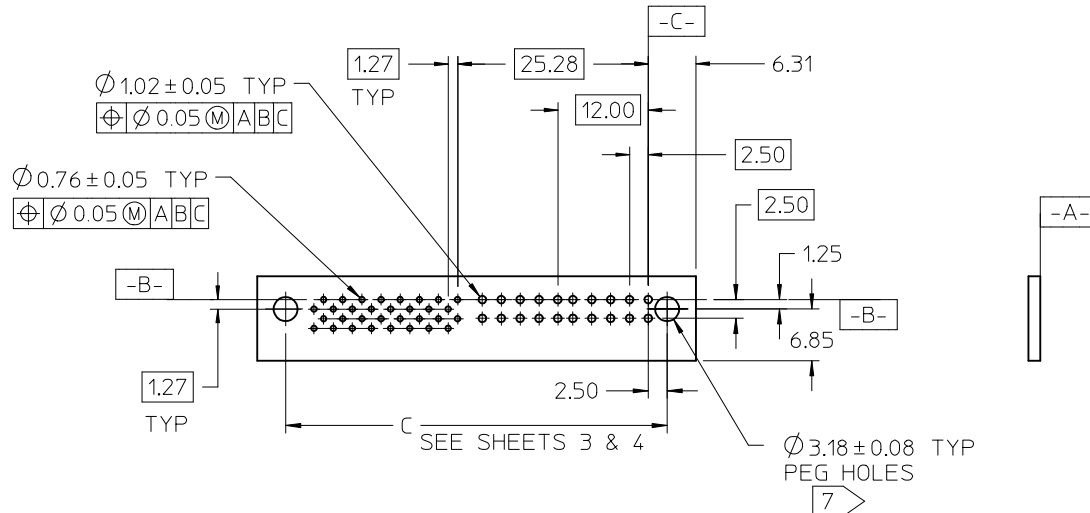
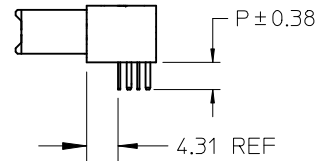

RECOMMENDED PCB LAYOUT: COMPONENT SIDE  
PEG HOLES OPTIONAL

| NO OF SIGNAL | MATERIAL NUMBER | DIM A REF | DIM P | PCB THK |
|--------------|-----------------|-----------|-------|---------|
| 12           | 45984-4111      | 35.5      | 4.50  | 3.18    |
| 16           | 45984-4121      | 38.0      |       |         |
| 20           | 45984-4131      | 40.6      |       |         |
| 24           | 45984-4141      | 43.1      |       |         |
| 28           | 45984-4151      | 45.6      |       |         |
| 32           | 45984-4161      | 48.2      | 3.60  | 2.36    |
| 36           | 45984-4171      | 50.7      |       |         |
| 40           | 45984-4181      | 53.3      |       |         |
| 12           | 45984-4112      | 35.5      |       |         |
| 16           | 45984-4122      | 38.0      |       |         |
| 20           | 45984-4132      | 40.6      | 2.90  | 1.57    |
| 24           | 45984-4142      | 43.1      |       |         |
| 28           | 45984-4152      | 45.6      |       |         |
| 32           | 45984-4162      | 48.2      |       |         |
| 36           | 45984-4172      | 50.7      |       |         |
| 40           | 45984-4182      | 53.3      | 2.90  | 1.57    |
| 12           | 45984-4113      | 35.5      |       |         |
| 16           | 45984-4123      | 38.0      |       |         |
| 20           | 45984-4133      | 40.6      |       |         |
| 24           | 45984-4143      | 43.1      |       |         |
| 28           | 45984-4153      | 45.6      |       |         |
| 32           | 45984-4163      | 48.2      |       |         |
| 36           | 45984-4173      | 50.7      |       |         |
| 40           | 45984-4183      | 53.3      |       |         |

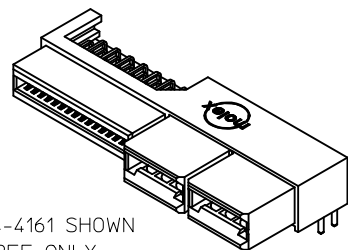

45984-4161 SHOWN  
FOR REF ONLY  
SEE CHART

| REVISED             | DESCRIPTION |
|---------------------|-------------|
| EC NO: UCP2009-0971 |             |
| DRWN:MBANDURA       | 2008/11/13  |
| CHKD:               | 2008/11/14  |
| APPR:APATEL         | 2008/11/17  |
| REV                 |             |

GENERAL TOLERANCES  
(UNLESS SPECIFIED)

|          | mm     | INCH  |
|----------|--------|-------|
| 4 PLACES | ± ---  | ± --- |
| 3 PLACES | ± ---  | ± --- |
| 2 PLACES | ± 0.25 | ± --- |
| 1 PLACE  | ± ---  | ± --- |

ANGULAR  $\pm 1/2^\circ$

DRAFT WHERE APPLICABLE  
MUST REMAIN  
WITHIN DIMENSIONS

DIMENSION STYLE  
MM ONLY

| DRAWN BY     | DATE       |
|--------------|------------|
| SAMIEC       | 2005/05/13 |
| CHECKED BY   | DATE       |
| SAMIEC       | 2005/05/13 |
| APPROVED BY  | DATE       |
| MARGULIS     | 2005/05/13 |
| MATERIAL NO. |            |

SCALE  
1:1

DESIGN UNITS  
METRIC

THIRD ANGLE  
PROJECTION

TITLE  
LPH RECEPTACLE ASSEMBLY  
RT ANGLE 4 CIRCUIT  
POWER CONNECTOR

**molex** MOLEX INCORPORATED

DOCUMENT NO.  
SD-45984-400

SHEET NO.  
1 OF 5

THIS DRAWING CONTAINS INFORMATION THAT IS PROPRIETARY TO MOLEX  
INCORPORATED AND SHOULD NOT BE USED WITHOUT WRITTEN PERMISSION

| NO OF SIGNAL | MATERIAL NUMBER | DIM A | DIM P | PCB THK |
|--------------|-----------------|-------|-------|---------|
| 12           | 45984-4211      | 35.5  | 4.50  | 3.18    |
| 16           | 45984-4221      | 38.0  |       |         |
| 20           | 45984-4231      | 40.6  |       |         |
| 24           | 45984-4241      | 43.1  |       |         |
| 28           | 45984-4251      | 45.6  |       |         |
| 32           | 45984-4261      | 48.2  | 3.60  | 2.36    |
| 36           | 45984-4271      | 50.7  |       |         |
| 40           | 45984-4281      | 53.3  |       |         |
| 12           | 45984-4212      | 35.5  |       |         |
| 16           | 45984-4222      | 38.0  |       |         |
| 20           | 45984-4232      | 40.6  | 2.90  | 1.57    |
| 24           | 45984-4242      | 43.1  |       |         |
| 28           | 45984-4252      | 45.6  |       |         |
| 32           | 45984-4262      | 48.2  |       |         |
| 36           | 45984-4272      | 50.7  |       |         |
| 40           | 45984-4282      | 53.3  | 2.90  | 1.57    |
| 12           | 45984-4213      | 35.5  |       |         |
| 16           | 45984-4223      | 38.0  |       |         |
| 20           | 45984-4233      | 40.6  |       |         |
| 24           | 45984-4243      | 43.1  |       |         |
| 28           | 45984-4253      | 45.6  |       |         |
| 32           | 45984-4263      | 48.2  |       |         |
| 36           | 45984-4273      | 50.7  |       |         |
| 40           | 45984-4283      | 53.3  |       |         |



OPTIONAL GUIDES  
SEE CHART



NO OF SIGNALS  
OPTIONAL  
SEE CHART

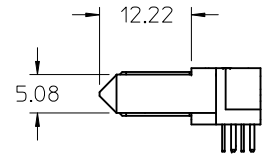

GUIDE POST OPTIONS

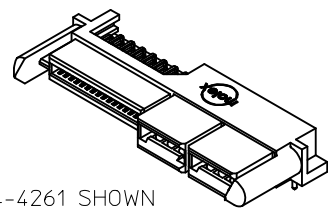

45984-4261 SHOWN  
FOR REF ONLY  
SEE CHART

|                          |             |
|--------------------------|-------------|
| REVISED                  | DESCRIPTION |
| EC NO: UCP2009-0971      |             |
| DRWN:MBANDURA 2008/11/13 |             |
| CHKD: 2008/11/14         |             |
| APPR:APATEL 2008/11/17   |             |
| REV                      |             |

|  |              |
|--|--------------|
| GENERAL TOLERANCES (UNLESS SPECIFIED)                |              |
|  | mm INCH      |
| 4 PLACES   | ± --- ± ---  |
| 3 PLACES   | ± --- ± ---  |
| 2 PLACES   | ± 0.25 ± --- |
| 1 PLACE  | ± --- ± ---  |
| ANGULAR ±1/2°  |              |
| DRAFT WHERE APPLICABLE MUST REMAIN WITHIN DIMENSIONS |              |

|                            |            |
|----------------------------|------------|
| DIMENSION STYLE<br>MM ONLY |            |
| DRAWN BY                   | DATE       |
| SAMIEC                     | 2005/05/13 |
| CHECKED BY                 | DATE       |
| SAMIEC                     | 2005/05/13 |
| APPROVED BY                | DATE       |
| MARGULIS                   | 2005/05/13 |
| MATERIAL NO.               |            |
| SIZE                       |            |
| A                          |            |

|   |                        |                        |
|---|------------------------|------------------------|
| SCALE<br>1:1  | DESIGN UNITS<br>METRIC | THIRD ANGLE PROJECTION |
| TITLE<br>LPH RECEPTACLE ASSEMBLY<br>RT ANGLE 4 CIRCUIT<br>POWER CONNECTOR |                        |                        |
| MOLEX INCORPORATED  |                        |                        |
| DOCUMENT NO.<br>SD-45984-400  | SHEET NO.<br>2 OF 5    |                        |

6

5

4

3

2

1



NO OF SIGNALS  
OPTIONAL  
SEE CHART

OPTIONAL PEGS

MOUNTING PEG OPTIONS

| NO OF SIGNAL | MATERIAL NUMBER | DIM A | DIM C | DIM P | PCB THK |
|--------------|-----------------|-------|-------|-------|---------|
| 12           | 45984-4311      | 35.5  | 37.90 | 4.50  | 3.18    |
| 16           | 45984-4321      | 38.0  | 40.44 |       |         |
| 20           | 45984-4331      | 40.6  | 42.98 |       |         |
| 24           | 45984-4341      | 43.1  | 45.52 |       |         |
| 28           | 45984-4351      | 45.6  | 48.06 |       |         |
| 32           | 45984-4361      | 48.2  | 50.60 |       |         |
| 36           | 45984-4371      | 50.7  | 53.14 | 3.60  | 2.36    |
| 40           | 45984-4381      | 53.3  | 55.68 |       |         |
| 12           | 45984-4312      | 35.5  | 37.90 |       |         |
| 16           | 45984-4322      | 38.0  | 40.44 |       |         |
| 20           | 45984-4332      | 40.6  | 42.98 |       |         |
| 24           | 45984-4342      | 43.1  | 45.52 |       |         |
| 28           | 45984-4352      | 45.6  | 48.06 | 2.90  | 1.57    |
| 32           | 45984-4362      | 48.2  | 50.60 |       |         |
| 36           | 45984-4372      | 50.7  | 53.14 |       |         |
| 40           | 45984-4382      | 53.3  | 55.68 |       |         |
| 12           | 45984-4313      | 35.5  | 37.90 |       |         |
| 16           | 45984-4323      | 38.0  | 40.44 |       |         |
| 20           | 45984-4333      | 40.6  | 42.98 |       |         |
| 24           | 45984-4343      | 43.1  | 45.52 |       |         |
| 28           | 45984-4353      | 45.6  | 48.06 |       |         |
| 32           | 45984-4363      | 48.2  | 50.60 |       |         |
| 36           | 45984-4373      | 50.7  | 53.14 |       |         |
| 40           | 45984-4383      | 53.3  | 55.68 |       |         |

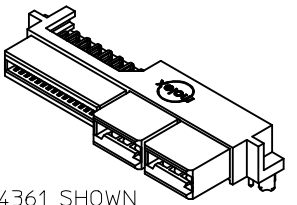

45984-4361 SHOWN  
FOR REF ONLY  
SEE CHART

|               |                     |            |             |
|---------------|---------------------|------------|-------------|
| REVISED       | EC NO: UCP2009-0971 | 2008/11/13 | DESCRIPTION |
| DRWN:MBANDURA | 2008/11/14          |            |             |
| CHKD:         | 2008/11/14          |            |             |
| APPR:APATEL   | 2008/11/17          |            |             |
| REV           |                     |            |             |

|  |        |       |
|--|--------|-------|
| GENERAL TOLERANCES (UNLESS SPECIFIED)                |        |       |
|  | mm     | INCH  |
| 4 PLACES   | ± ---  | ± --- |
| 3 PLACES   | ± ---  | ± --- |
| 2 PLACES   | ± 0.25 | ± --- |
| 1 PLACE  | ± ---  | ± --- |
| ANGULAR ±1/2°  |        |       |
| DRAFT WHERE APPLICABLE MUST REMAIN WITHIN DIMENSIONS |        |       |

|                 |            |
|-----------------|------------|
| DIMENSION STYLE |            |
| MM ONLY         |            |
| DRAWN BY        | DATE       |
| SAMIEC          | 2005/05/13 |
| CHECKED BY      | DATE       |
| SAMIEC          | 2005/05/13 |
| APPROVED BY     | DATE       |
| MARGULIS        | 2005/05/13 |
| MATERIAL NO.    |            |

|   |              |                        |
|---|--------------|------------------------|
| SCALE   | DESIGN UNITS | THIRD ANGLE PROJECTION |
| 1:1   | METRIC       |                        |
| TITLE   |              |                        |
| LPH RECEPTACLE ASSEMBLY<br>RT ANGLE 4 CIRCUIT<br>POWER CONNECTOR  |              |                        |
| MOLEX INCORPORATED  |              |                        |
| DOCUMENT NO.  | SHEET NO.    |                        |
| SD-45984-400  | 3 OF 5       |                        |
| THIS DRAWING CONTAINS INFORMATION THAT IS PROPRIETARY TO MOLEX INCORPORATED AND SHOULD NOT BE USED WITHOUT WRITTEN PERMISSION |              |                        |

5

4

3

2

1



OPTIONAL GUIDES

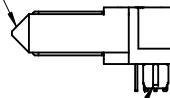

OPTIONAL PEGS

NO OF SIGNALS  
OPTIONAL  
SEE CHART

GUIDE POST & MOUNTING PEG OPTIONS

| NO OF SIGNAL | MATERIAL NUMBER | DIM A | DIM C | DIM P | PCB THK |
|--------------|-----------------|-------|-------|-------|---------|
| 12           | 45984-4411      | 35.5  | 37.90 | 4.50  | 3.18    |
| 16           | 45984-4421      | 38.0  | 40.44 |       |         |
| 20           | 45984-4431      | 40.6  | 42.98 |       |         |
| 24           | 45984-4441      | 43.1  | 45.52 |       |         |
| 28           | 45984-4451      | 45.6  | 48.06 |       |         |
| 32           | 45984-4461      | 48.2  | 50.60 |       |         |
| 36           | 45984-4471      | 50.7  | 53.14 | 3.60  | 2.36    |
| 40           | 45984-4481      | 53.3  | 55.68 |       |         |
| 12           | 45984-4412      | 35.5  | 37.90 |       |         |
| 16           | 45984-4422      | 38.0  | 40.44 |       |         |
| 20           | 45984-4432      | 40.6  | 42.98 |       |         |
| 24           | 45984-4442      | 43.1  | 45.52 |       |         |
| 28           | 45984-4452      | 45.6  | 48.06 | 2.90  | 1.57    |
| 32           | 45984-4462      | 48.2  | 50.60 |       |         |
| 36           | 45984-4472      | 50.7  | 53.14 |       |         |
| 40           | 45984-4482      | 53.3  | 55.68 |       |         |
| 12           | 45984-4413      | 35.5  | 37.90 |       |         |
| 16           | 45984-4423      | 38.0  | 40.44 |       |         |
| 20           | 45984-4433      | 40.6  | 42.98 |       |         |
| 24           | 45984-4443      | 43.1  | 45.52 |       |         |
| 28           | 45984-4453      | 45.6  | 48.06 |       |         |
| 32           | 45984-4463      | 48.2  | 50.60 |       |         |
| 36           | 45984-4473      | 50.7  | 53.14 |       |         |
| 40           | 45984-4483      | 53.3  | 55.68 |       |         |

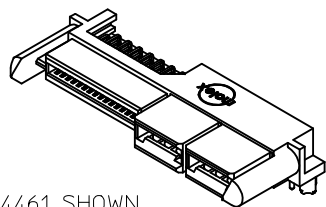

45984-4461 SHOWN  
FOR REF ONLY  
SEE CHART

|               |                     |            |            |
|---------------|---------------------|------------|------------|
| REVISED       | EC NO: UCP2009-0971 | 2008/11/13 | 2008/11/17 |
| DRWN:MBANDURA | 2008/11/13          |            |            |
| CHKD:         | 2008/11/14          |            |            |
| APPR:APATEL   | 2008/11/17          |            |            |
| REV           | DESCRIPTION         |            |            |

GENERAL TOLERANCES  
(UNLESS SPECIFIED)

|          | mm     | INCH  |
|----------|--------|-------|
| 4 PLACES | ± ---  | ± --- |
| 3 PLACES | ± ---  | ± --- |
| 2 PLACES | ± 0.25 | ± --- |
| 1 PLACE  | ± ---  | ± --- |

ANGULAR ±1/2°

DRAFT WHERE APPLICABLE  
MUST REMAIN  
WITHIN DIMENSIONS

DIMENSION STYLE  
MM ONLY

|              |            |
|--------------|------------|
| DRAWN BY     | DATE       |
| SAMIEC       | 2005/05/13 |
| CHECKED BY   | DATE       |
| SAMIEC       | 2005/05/13 |
| APPROVED BY  | DATE       |
| MARGULIS     | 2005/05/13 |
| MATERIAL NO. |            |

SCALE  
1:1

DESIGN UNITS  
METRIC

THIRD ANGLE  
PROJECTION

TITLE  
LPH RECEPTACLE ASSEMBLY  
RT ANGLE 4 CIRCUIT  
POWER CONNECTOR

**molex** MOLEX INCORPORATED

DOCUMENT NO.  
SD-45984-400

SHEET NO.  
4 OF 5

THIS DRAWING CONTAINS INFORMATION THAT IS PROPRIETARY TO MOLEX  
INCORPORATED AND SHOULD NOT BE USED WITHOUT WRITTEN PERMISSION

6

5

4

3

2

1



| NO. OF SIGNAL | DIM. D |
|---------------|--------|
| 12            | 8.00   |
| 16            | 10.54  |
| 20            | 13.08  |
| 24            | 15.62  |
| 28            | 18.16  |
| 32            | 20.70  |
| 36            | 23.24  |
| 40            | 25.78  |

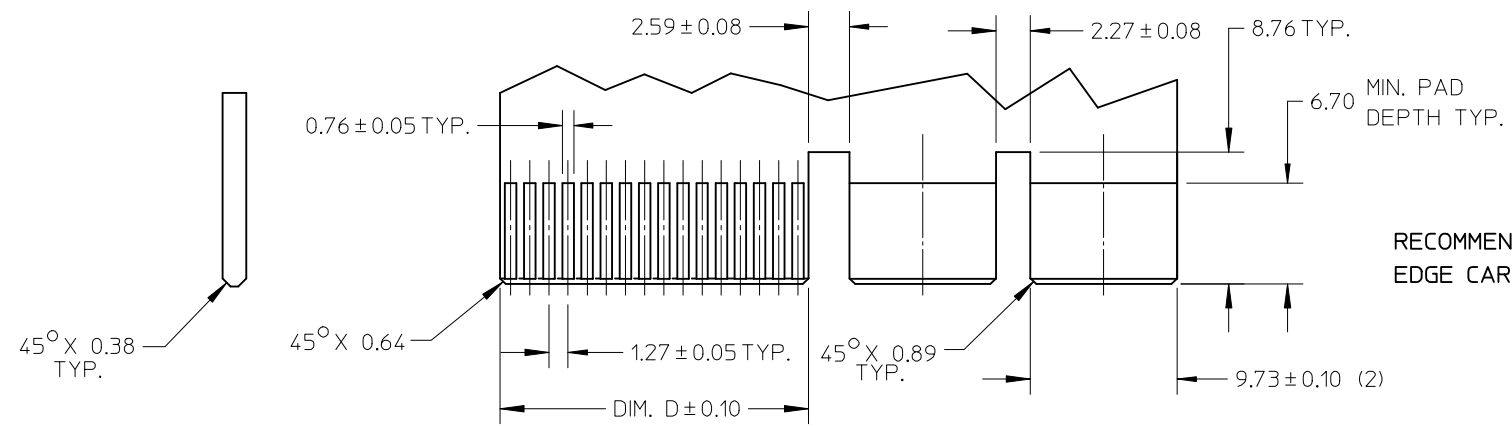

RECOMMENDED EDGE CARD LAYOUT  
EDGE CARD THICKNESS: 1.57/0.62



|         |                     |            |             |
|---------|---------------------|------------|-------------|
| REVISED | EC NO: UCP2009-0971 | 2008/11/13 | DESCRIPTION |
|         | DRWN:MBANDURA       | 2008/11/14 |             |
|         | CHKD:               |            |             |
|         | APPR:APATEL         | 2008/11/17 |             |
| REV     |                     |            |             |

|  |        |       |
|--|--------|-------|
| GENERAL TOLERANCES (UNLESS SPECIFIED)                      |        |       |
|  | mm     | INCH  |
| 4 PLACES   | ± ---  | ± --- |
| 3 PLACES   | ± ---  | ± --- |
| 2 PLACES   | ± 0.25 | ± --- |
| 1 PLACE  | ± ---  | ± --- |
| ANGULAR ± 1/2°   |        |       |
| DRAFT WHERE APPLICABLE<br>MUST REMAIN<br>WITHIN DIMENSIONS |        |       |

|                            |                    |
|----------------------------|--------------------|
| DIMENSION STYLE<br>MM ONLY |                    |
| DRAWN BY<br>SAMIEC         | DATE<br>2005/05/13 |
| CHECKED BY<br>SAMIEC       | DATE<br>2005/05/13 |
| APPROVED BY<br>MARGULIS    | DATE<br>2005/05/13 |
| MATERIAL NO.               |                    |

|   |                        |                        |
|---|------------------------|------------------------|
| SCALE<br>2:1  | DESIGN UNITS<br>METRIC | THIRD ANGLE PROJECTION |
| TITLE<br>LPH RECEPTACLE ASSEMBLY<br>RT ANGLE 4 CIRCUIT<br>POWER CONNECTOR   |                        |                        |
| MOLEX INCORPORATED  |                        |                        |
| DOCUMENT NO.<br>SD-45984-400  | SHEET NO.<br>5 OF 5    |                        |
| THIS DRAWING CONTAINS INFORMATION THAT IS PROPRIETARY TO MOLEX INCORPORATED AND SHOULD NOT BE USED WITHOUT WRITTEN PERMISSION |                        |                        |

5

4

3

2

1