

FEATURES

- ❑ Four 8-bit Registers
- ❑ Implements Double 2-Stage Pipeline or Single 4-Stage Pipeline Register
- ❑ Hold, Shift, and Load Instructions
- ❑ Separate Data In and Data Out Pins
- ❑ High-Speed, Low Power CMOS Technology
- ❑ Three-State Outputs
- ❑ DESC SMD No. 5962-91762
- ❑ Available 100% Screened to MIL-STD-883, Class B
- ❑ Replaces IDT29FCT520/IDT29FCT521 and AMD Am29520/Am29521
- ❑ Package Styles Available:
 - 24-pin Plastic DIP
 - 24-pin Ceramic DIP
 - 28-pin Plastic LCC, J-Lead
 - 28-pin Ceramic LCC
 - 24-pin Ceramic Flatpack

DESCRIPTION

The L29C520 and L29C521 are pin-for-pin compatible with the IDT29FCT520/IDT29FCT521 and AMD Am29520/Am29521, implemented in low power CMOS.

The L29C520 and L29C521 contain four registers which can be configured as two independent, 2-level pipelines or as one 4-level pipeline.

The Instruction pins, I1-0, control the loading of the registers. For either device, the registers may be configured as a four-stage delay line, with data loaded into I1 and shifted sequentially through R2, R3, and R4. Also, for the L29C520, data may be loaded from the inputs into either R1 or R3 with only R2 or R4 shifting. The L29C521 differs from the L29C520 in that R2 and R4 remain unchanged during this type of data load, as shown in Tables 1 and 2. Finally, I1-0 may be set to prevent any register from changing.

The S1-0 select lines control a 4-to-1 multiplexer which routes the contents of any of the registers to the Y output pins. The independence of the I and S controls allows simultaneous write and read operations on different registers.

TABLE 1.
L29C520 INSTRUCTION TABLE

I1	I0	Description
L	L	D→R1 R1→R2 R2→R3 R3→R4
L	H	HOLD HOLD D→R3 R3→R4
H	L	D→R1 R1→R2 HOLD HOLD
H	H	ALL REGISTERS ON HOLD

TABLE 2.
L29C521 INSTRUCTION TABLE

I1	I0	Description
L	L	D→R1 R1→R2 R2→R3 R3→R4
L	H	HOLD HOLD D→R3 HOLD
H	L	D→R1 HOLD HOLD HOLD
H	H	ALL REGISTERS ON HOLD

TABLE 3. OUTPUT SELECT

S1	S0	Register Selected
L	L	Register 4
L	H	Register 3
H	L	Register 2
H	H	Register 1

L29C520/521 BLOCK DIAGRAM

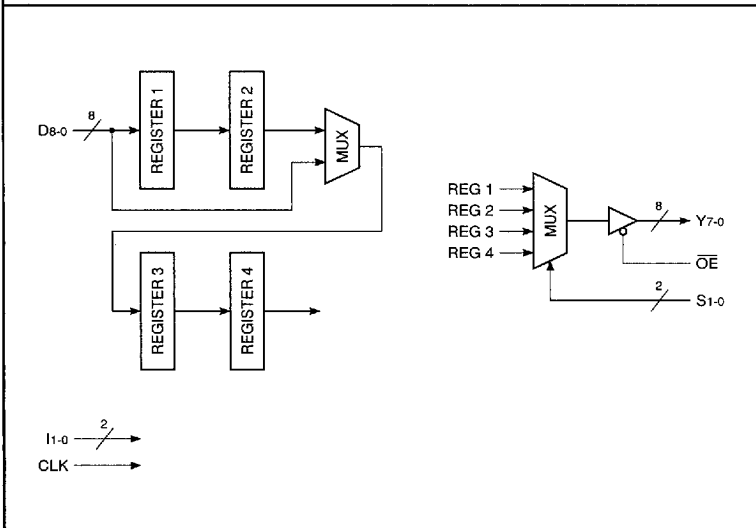

4 x 8-bit Multilevel Pipeline Register

MAXIMUM RATINGS *Above which useful life may be impaired (Notes 1, 2, 3, 8)*

Storage temperature	-65°C to +150°C
Operating ambient temperature	-55°C to +125°C
V _{CC} supply voltage with respect to ground	-0.5 V to +7.0 V
Input signal with respect to ground	-3.0 V to +7.0 V
Signal applied to high impedance output	-3.0 V to +7.0 V
Output current into low outputs	25 mA
Latchup current	> 400 mA

OPERATING CONDITIONS *To meet specified electrical and switching characteristics*

Mode	Temperature Range (Ambient)	Supply Voltage
Active Operation, Commercial	0°C to +70°C	4.75 V ≤ V _{CC} ≤ 5.25 V
Active Operation, Military	-55°C to +125°C	4.50 V ≤ V _{CC} ≤ 5.50 V

ELECTRICAL CHARACTERISTICS *Over Operating Conditions (Note 4)*

Symbol	Parameter	Test Condition	Min	Typ	Max	Unit
V _{OH}	Output High Voltage	V _{CC} = Min., I _{OH} = -15.0 mA	2.4			V
V _{OL}	Output Low Voltage	V _{CC} = Min., I _{OL} = 24.0 mA			0.5	V
V _{IH}	Input High Voltage		2.0		V _{CC}	V
V _{IL}	Input Low Voltage	(Note 3)	0.0		0.8	V
I _{Ix}	Input Current	Ground ≤ V _{IN} ≤ V _{CC} (Note 12)			±20	μA
I _{OZ}	Output Leakage Current	Ground ≤ V _{OUT} ≤ V _{CC} (Note 12)			±20	μA
I _{CC1}	V _{CC} Current, Dynamic	(Notes 5, 6)			30	mA
I _{CC2}	V _{CC} Current, Quiescent	(Note 7)			1.5	mA

SWITCHING CHARACTERISTICS
COMMERCIAL OPERATING RANGE (0°C to +70°C) Notes 9, 10 (ns)

Symbol	Parameter	L29C520/521-			
		22		14	
		Min	Max	Min	Max
t _{PD}	Clock to Output Delay		22		14
t _{SEL}	Select to Output Delay		20		13
t _{PW}	Clock Pulse Width	10		7	
t _{SI}	Instruction Setup Time	10		5	
t _{HI}	Instruction Hold Time	3		1	
t _{SD}	Data Setup Time	10		5	
t _{HD}	Data Hold Time	3		1	
t _{ENA}	Three-State Output Enable Delay (Note 11)		21		15
t _{DIS}	Three-State Output Disable Delay (Note 11)		15		12

MILITARY OPERATING RANGE (-55°C to +125°C) Notes 9, 10 (ns)

Symbol	Parameter	L29C520/521-					
		30		24		16	
		Min	Max	Min	Max	Min	Max
t _{PD}	Clock to Output Delay		30		24		16
t _{SEL}	Select to Output Delay		30		22		15
t _{PW}	Clock Pulse Width	15		10		8	
t _{SI}	Instruction Setup Time	15		10		6	
t _{HI}	Instruction Hold Time	5		3		2	
t _{SD}	Data Setup Time	15		10		6	
t _{HD}	Data Hold Time	5		3		2	
t _{ENA}	Three-State Output Enable Delay (Note 11)		25		22		16
t _{DIS}	Three-State Output Disable Delay (Note 11)		20		16		13

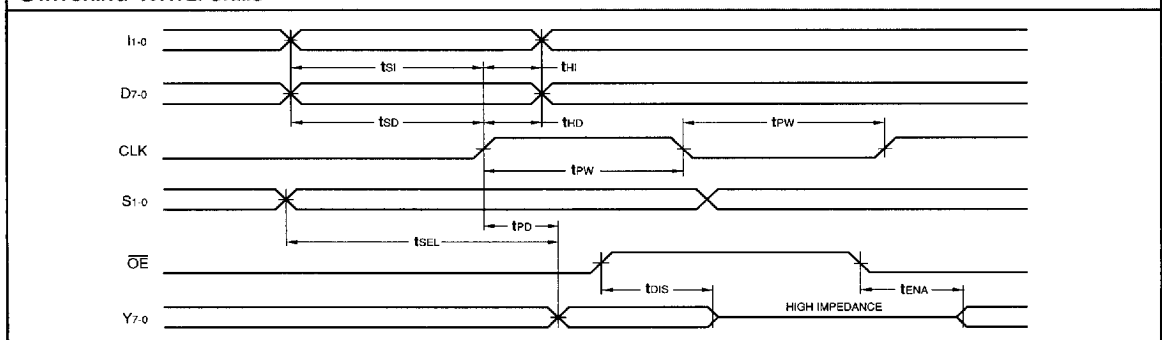
SWITCHING WAVEFORMS

NOTES

1. Maximum Ratings indicate stress specifications only. Functional operation of these products at values beyond those indicated in the Operating Conditions table is not implied. Exposure to maximum rating conditions for extended periods may affect reliability.

2. The products described by this specification include internal circuitry designed to protect the chip from damaging substrate injection currents and accumulations of static charge. Nevertheless, conventional precautions should be observed during storage, handling, and use of these circuits in order to avoid exposure to excessive electrical stress values.

3. This device provides hard clamping of transient undershoot and overshoot. Input levels below ground or above VCC will be clamped beginning at -0.6 V and $V_{CC} + 0.6\text{ V}$. The device can withstand indefinite operation with inputs in the range of -0.5 V to $+7.0\text{ V}$. Device operation will not be adversely affected, however, input current levels will be well in excess of 100 mA .

4. Actual test conditions may vary from those designated but operation is guaranteed as specified.

5. Supply current for a given application can be accurately approximated by:

$$\frac{NCV^2F}{4}$$

where

- N = total number of device outputs
- C = capacitive load per output
- V = supply voltage
- F = clock frequency

6. Tested with all outputs changing every cycle and no load, at a 5 MHz clock rate.

7. Tested with all inputs within 0.1 V of VCC or Ground, no load.

8. These parameters are guaranteed but not 100% tested.

9. AC specifications are tested with input transition times less than 3 ns , output reference levels of 1.5 V (except t_{ENA}/t_{DIS} test), and input levels of nominally 0 to 3.0 V . Output loading may be a resistive divider which provides for specified IOH and IOL at an output voltage of $V_{OH\text{ min}}$ and $V_{OL\text{ max}}$ respectively. Alternatively, a diode bridge with upper and lower current sources of IOH and IOL respectively, and a balancing voltage of 1.5 V may be used. Parasitic capacitance is 30 pF minimum, and may be distributed. For t_{ENABLE} and $t_{DISABLE}$ measurements, the load current is increased to 10 mA to reduce the RC delay component of the measurement.

This device has high-speed outputs capable of large instantaneous current pulses and fast turn-on/turn-off times. As a result, care must be exercised in the testing of this device. The following measures are recommended:

a. A $0.1\text{ }\mu\text{F}$ ceramic capacitor should be installed between VCC and Ground leads as close to the Device Under Test (DUT) as possible. Similar capacitors should be installed between device VCC and the tester common, and device ground and tester common.

b. Ground and VCC supply planes must be brought directly to the DUT socket or contactor fingers.

c. Input voltages should be adjusted to compensate for inductive ground and VCC noise to maintain required DUT input levels relative to the DUT ground pin.

10. Each parameter is shown as a minimum or maximum value. Input requirements are specified from the point of view of the external system driving the chip. Setup time, for example, is specified as a minimum since the external system must supply at least that much time to meet the worst-case requirements of all parts. Responses from the internal circuitry are specified from

the point of view of the device. Output delay, for example, is specified as a maximum since worst-case operation of any device always provides data within that time.

11. Transition is measured $\pm 200\text{ mV}$ from steady-state voltage with specified loading.

12. These parameters are only tested at the high temperature extreme, which is the worst case for leakage current.

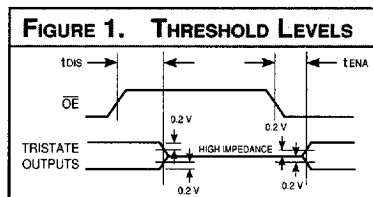

L29C520 — ORDERING INFORMATION

24-pin — 0.3" wide

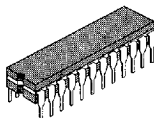
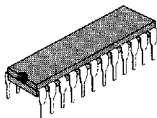
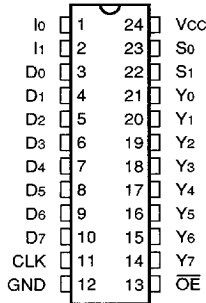

28-pin

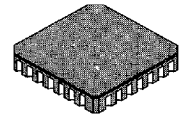
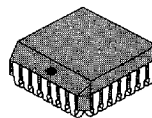
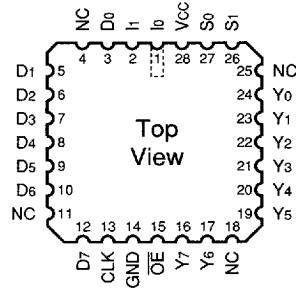

5

Speed	Plastic DIP (P2)	Ceramic DIP (C1)	Plastic J-Lead Chip Carrier (J4)	Ceramic Leadless Chip Carrier (K1)
0°C to +70°C — COMMERCIAL SCREENING				
22 ns	L29C520PC22	L29C520CC22	L29C520JC22	L29C520KC22
14 ns	L29C520PC14	L29C520CC14	L29C520JC14	L29C520KC14
-55°C to +125°C — COMMERCIAL SCREENING				
30 ns		L29C520CM30		L29C520KM30
24 ns		L29C520CM24		L29C520KM24
16 ns		L29C520CM16		L29C520KM16
-55°C to +125°C — MIL-STD-883 COMPLIANT				
30 ns		L29C520CMB30		L29C520KMB30
24 ns		L29C520CMB24		L29C520KMB24
16 ns		L29C520CMB16		L29C520KMB16

Pipeline Registers

L29C520 — ORDERING INFORMATION

24-pin

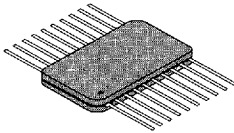
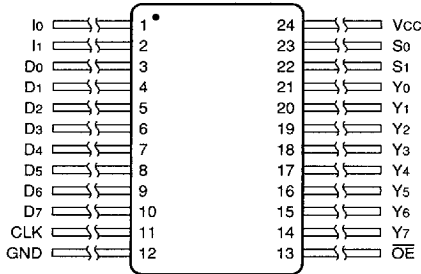

Speed	Ceramic Flatpack (M1)
	0°C to +70°C — COMMERCIAL SCREENING
22 ns 14 ns	L29C520MC22 L29C520MC14
	-55°C to +125°C — COMMERCIAL SCREENING
30 ns 24 ns 16 ns	L29C520MM30 L29C520MM24 L29C520MM16
	-55°C to +125°C — MIL-STD-883 COMPLIANT
30 ns 24 ns 16 ns	L29C520MMB30 L29C520MMB24 L29C520MMB16

Pipeline Registers

L29C521 — ORDERING INFORMATION

24-pin — 0.3" wide

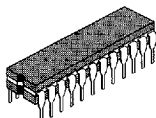
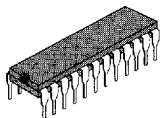
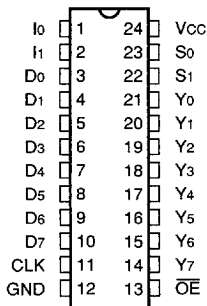

28-pin

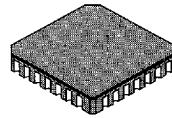
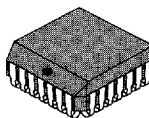
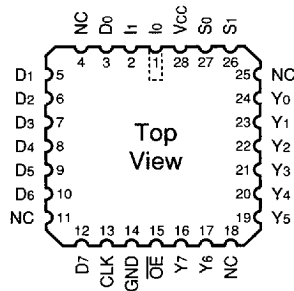

Speed	Plastic DIP (P2)	Ceramic DIP (C1)	Plastic J-Lead Chip Carrier (J4)	Ceramic Leadless Chip Carrier (K1)
0°C to +70°C — COMMERCIAL SCREENING				
22 ns	L29C521PC22	L29C521CC22	L29C521JC22	L29C521KC22
14 ns	L29C521PC14	L29C521CC14	L29C521JC14	L29C521KC14
-55°C to +125°C — COMMERCIAL SCREENING				
30 ns		L29C521CM30		L29C521KM30
24 ns		L29C521CM24		L29C521KM24
16 ns		L29C521CM16		L29C521KM16
-55°C to +125°C — MIL-STD-883 COMPLIANT				
30 ns		L29C521CMB30		L29C521KMB30
24 ns		L29C521CMB24		L29C521KMB24
16 ns		L29C521CMB16		L29C521KMB16

Pipeline Registers

L29C521 — ORDERING INFORMATION

24-pin

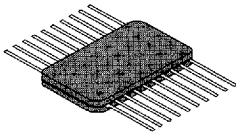
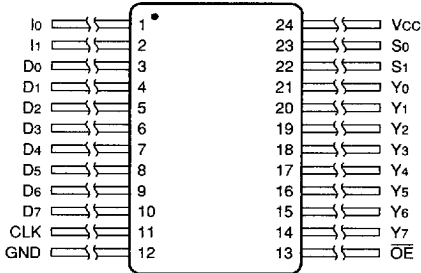

Speed	Ceramic Flatpack (M1)
	0°C to +70°C — COMMERCIAL SCREENING
22 ns 14 ns	L29C521MC22 L29C521MC14
	-55°C to +125°C — COMMERCIAL SCREENING
30 ns 24 ns 16 ns	L29C521MM30 L29C521MM24 L29C521MM16
	-55°C to +125°C — MIL-STD-883 COMPLIANT
30 ns 24 ns 16 ns	L29C521MMB30 L29C521MMB24 L29C521MMB16

Pipeline Registers