

FDMS3672

N-Channel UltraFET Trench MOSFET

100V, 22A, 23mΩ

Features

- Max $r_{DS(on)}$ = 23mΩ at $V_{GS} = 10V$, $I_D = 7.4A$
- Max $r_{DS(on)}$ = 29mΩ at $V_{GS} = 6V$, $I_D = 6.6A$
- Typ $Q_g = 31nC$ at $V_{GS} = 10V$
- Low Miller Charge
- Optimized efficiency at high frequencies
- RoHS Compliant



General Description

UltraFET devices combine characteristics that enable benchmark efficiency in power conversion applications. Optimized for $r_{DS(on)}$, low ESR, low total and Miller gate charge, these devices are ideal for high frequency DC to DC converters.

Application

- DC - DC Conversion

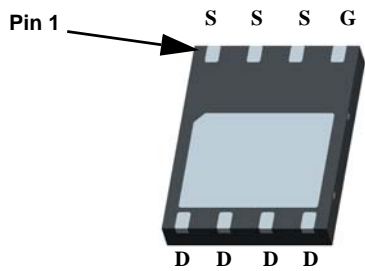

Power (Bottom view)

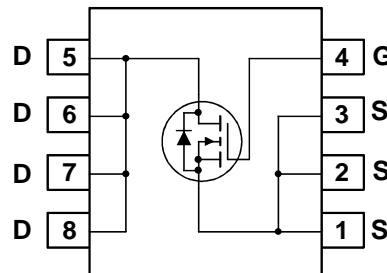

MOSFET Maximum Ratings $T_A = 25^\circ C$ unless otherwise noted

Symbol	Parameter	Rated Value	Units
V_{DS}	Drain to Source Voltage	100	V
V_{GS}	Gate to Source Voltage	±20	V
I_D	Drain Current -Continuous (Package limited) $T_C = 25^\circ C$	22	A
	-Continuous (Silicon limited) $T_C = 25^\circ C$	41	
	-Continuous $T_A = 25^\circ C$ (Note 1a)	7.4	
	-Pulsed	30	
P_D	Power Dissipation $T_C = 25^\circ C$	78	W
	Power Dissipation $T_A = 25^\circ C$ (Note 1a)	2.5	
T_J, T_{STG}	Operating and Storage Junction Temperature Range	-55 to +150	$^\circ C$

Thermal Characteristics

$R_{\theta JC}$	Thermal Resistance, Junction to Case	1.6	$^\circ C/W$
$R_{\theta JA}$	Thermal Resistance, Junction to Ambient (Note 1a)	50	

Package Marking and Ordering Information

Device Marking	Device	Package	Reel Size	Tape Width	Quantity
FDMS3672	FDMS3672	Power 56	13"	12mm	3000 units

Electrical Characteristics $T_J = 25^\circ\text{C}$ unless otherwise noted

Symbol	Parameter	Test Conditions	Min	Typ	Max	Units
--------	-----------	-----------------	-----	-----	-----	-------

Off Characteristics

BV_{DSS}	Drain to Source Breakdown Voltage	$I_D = 250\mu\text{A}, V_{GS} = 0\text{V}$	100			V
$\frac{\Delta BV_{DSS}}{\Delta T_J}$	Breakdown Voltage Temperature Coefficient	$I_D = 250\mu\text{A}$, referenced to 25°C		104		mV/ $^\circ\text{C}$
I_{DSS}	Zero Gate Voltage Drain Current	$V_{DS} = 80\text{V}, V_{GS} = 0\text{V}, T_J = 55^\circ\text{C}$			1 10	μA
I_{GSS}	Gate to Source Leakage Current	$V_{GS} = \pm 20\text{V}, V_{DS} = 0\text{V}$			± 100	nA

On Characteristics

$V_{GS(th)}$	Gate to Source Threshold Voltage	$V_{GS} = V_{DS}, I_D = 250\mu\text{A}$	2	3.1	4	V
$\frac{\Delta V_{GS(th)}}{\Delta T_J}$	Gate to Source Threshold Voltage Temperature Coefficient	$I_D = 250\mu\text{A}$, referenced to 25°C		-11		mV/ $^\circ\text{C}$
$r_{DS(on)}$	Drain to Source On Resistance	$V_{GS} = 10\text{V}, I_D = 7.4\text{A}$ $V_{GS} = 6\text{V}, I_D = 6.6\text{A}$ $V_{GS} = 10\text{V}, I_D = 7.4\text{A}, T_J = 125^\circ\text{C}$		19 24 33	23 29 40	m Ω
g_{FS}	Forward Transconductance	$V_{DS} = 10\text{V}, I_D = 7.4\text{A}$		20		S

Dynamic Characteristics

C_{iss}	Input Capacitance	$V_{DS} = 50\text{V}, V_{GS} = 0\text{V}, f = 1\text{MHz}$		2015	2680	pF
C_{oss}	Output Capacitance			210	280	pF
C_{rss}	Reverse Transfer Capacitance			90	135	pF
R_g	Gate Resistance		$f = 1\text{MHz}$	1.3		Ω

Switching Characteristics

$t_{d(on)}$	Turn-On Delay Time	$V_{DD} = 50\text{V}, I_D = 7.4\text{A}, V_{GS} = 10\text{V}, R_{GEN} = 6\Omega$		23	37	ns
t_r	Rise Time			11	20	ns
$t_{d(off)}$	Turn-Off Delay Time			36	58	ns
t_f	Fall Time			8	16	ns
Q_g	Total Gate Charge at 10V	$V_{GS} = 0\text{V}$ to 10V	$V_{DD} = 50\text{V}, I_D = 7.4\text{A}$	31	44	nC
Q_g	Total Gate Charge at 4.5V	$V_{GS} = 0\text{V}$ to 4.5V				nC
Q_{gs}	Gate to Source Gate Charge			9.5		nC
Q_{gd}	Gate to Drain "Miller" Charge			8		nC

Drain-Source Diode Characteristics

V_{SD}	Source to Drain Diode Forward Voltage	$V_{GS} = 0\text{V}, I_S = 7.4\text{A}$ (Note 2)		0.8	1.2	V
t_{rr}	Reverse Recovery Time	$I_F = 7.4\text{A}, di/dt = 100\text{A}/\mu\text{s}$		52	78	ns
Q_{rr}	Reverse Recovery Charge			101	152	nC

Notes:

1: $R_{\theta JA}$ is determined with the device mounted on a 1in^2 pad 2 oz copper pad on a $1.5 \times 1.5\text{in.}$ board of FR-4 material. $R_{\theta JC}$ is guaranteed by design while $R_{\theta CA}$ is determined by the user's board design.

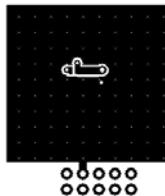

a. $50^\circ\text{C}/\text{W}$ when mounted on a 1in^2 pad of 2 oz copper



b. $125^\circ\text{C}/\text{W}$ when mounted on a minimum pad of 2 oz copper

2: Pulse Test: Pulse Width < $300\mu\text{s}$, Duty cycle < 2.0%.

Typical Characteristics $T_J = 25^\circ\text{C}$ unless otherwise noted

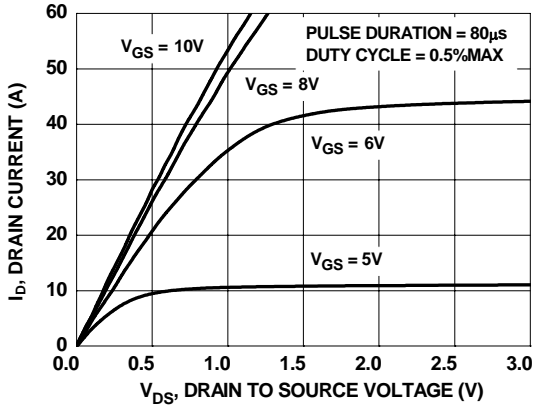

Figure 1. On-Region Characteristics

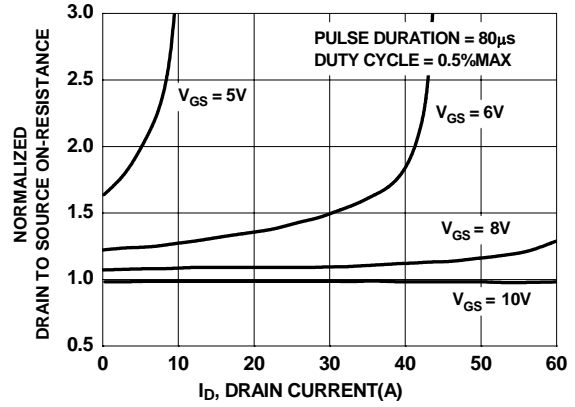

Figure 2. Normalized On-Resistance vs Drain Current and Gate Voltage

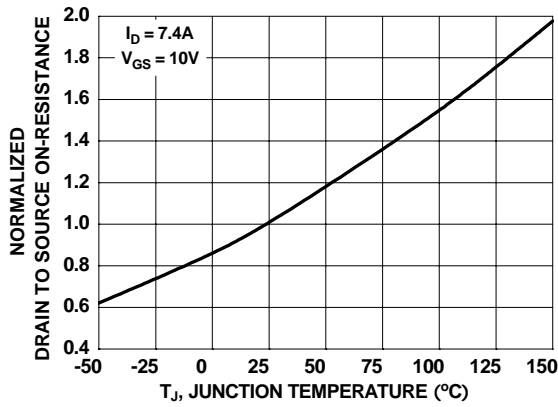

Figure 3. Normalized On-Resistance vs Junction Temperature

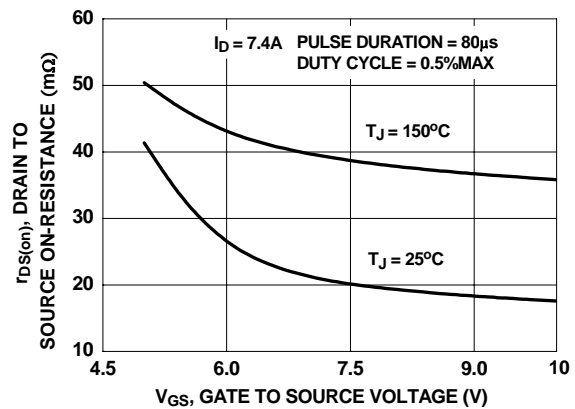

Figure 4. On-Resistance vs Gate to Source Voltage

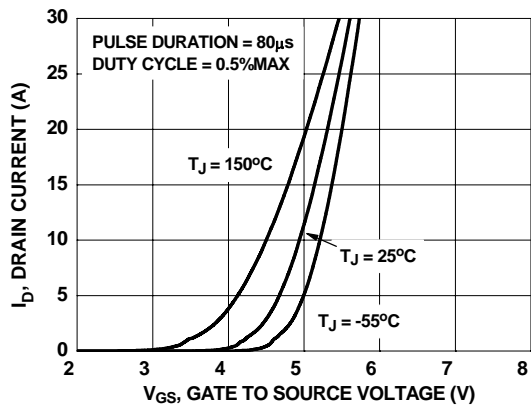

Figure 5. Transfer Characteristics

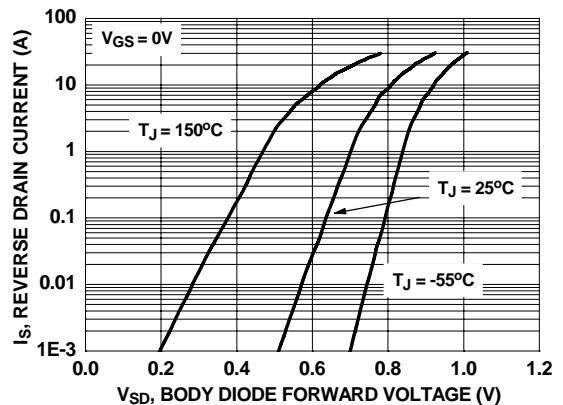

Figure 6. Source to Drain Diode Forward Voltage vs Source Current

Typical Characteristics $T_J = 25^\circ\text{C}$ unless otherwise noted

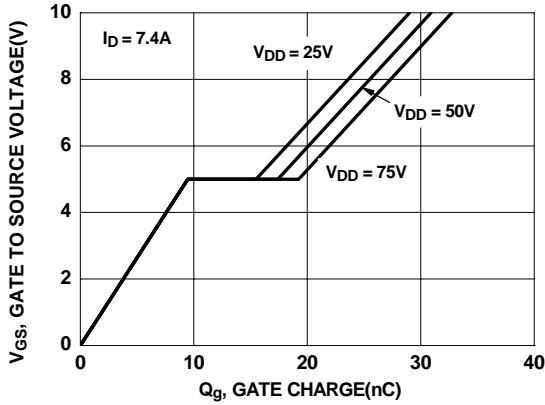

Figure 7. Gate Charge Characteristics

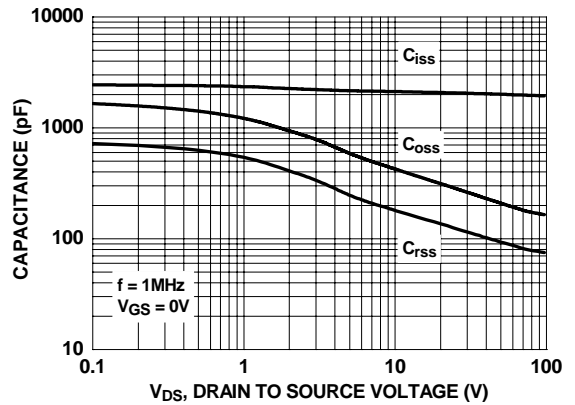

Figure 8. Capacitance vs Drain to Source Voltage

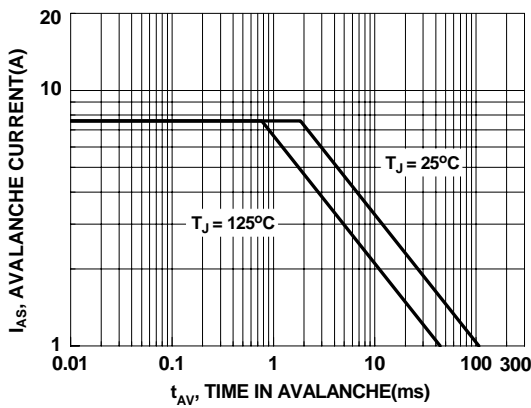

Figure 9. Unclamped Inductive Switching Capability

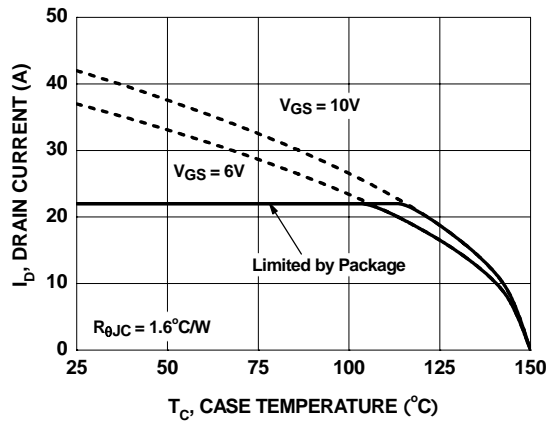

Figure 10. Maximum Continuous Drain Current vs Case Temperature

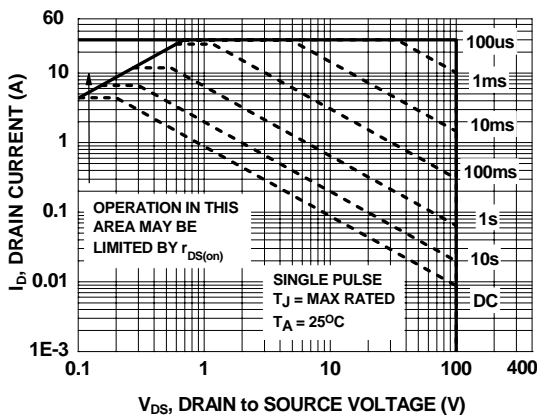

Figure 11. Forward Bias Safe Operating Area

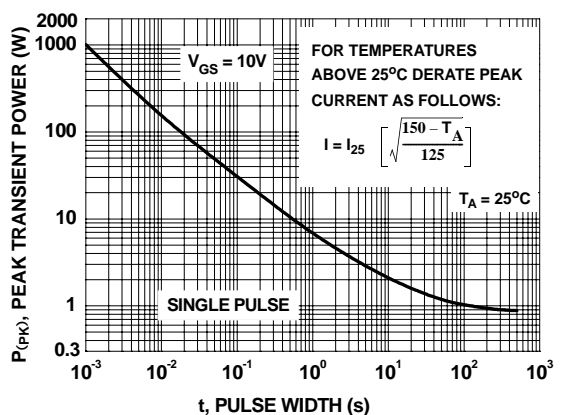
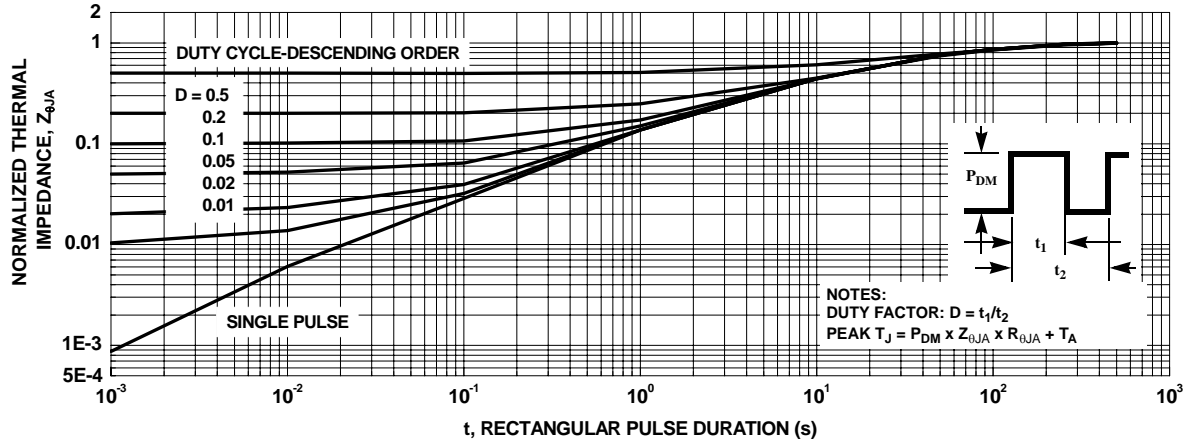
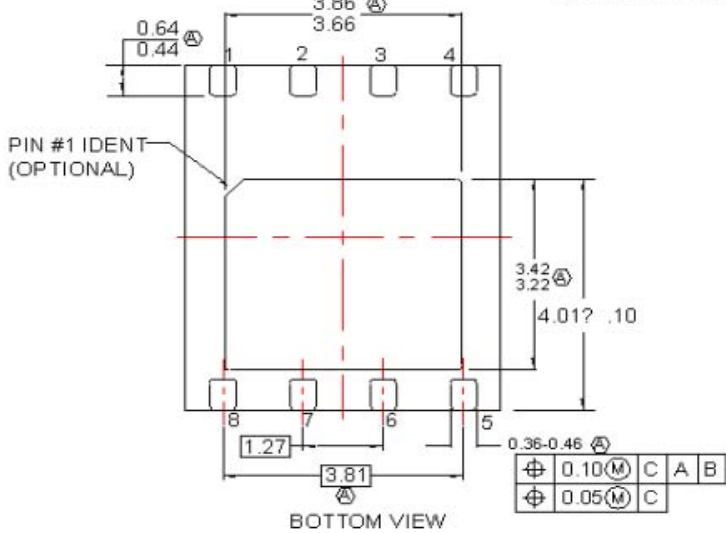
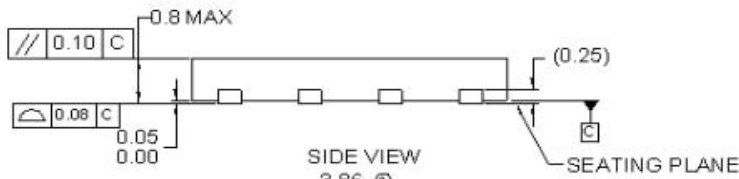
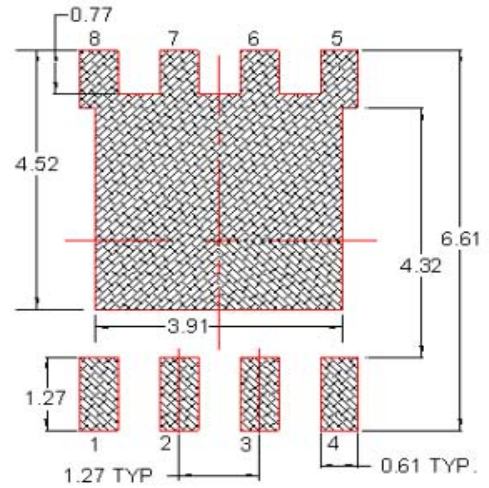
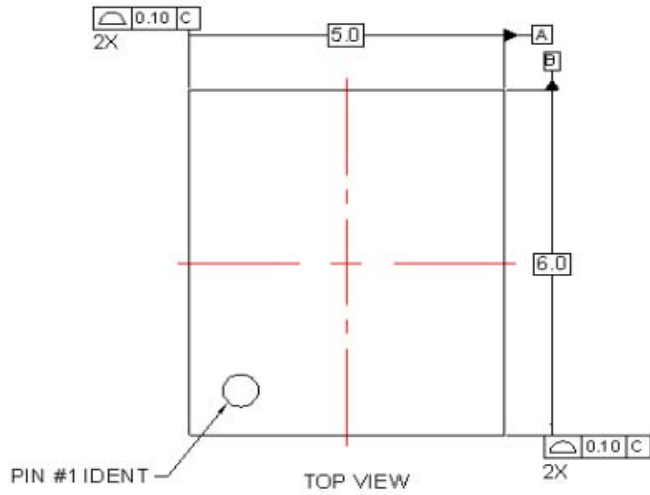

Figure 12. Single Pulse Maximum Power Dissipation

Typical Characteristics $T_J = 25^\circ\text{C}$ unless otherwise noted





NOTES:

- (A) DOES NOT FULLY CONFORM TO JEDEC REGISTRATION, MO-229. DATED 11/2001.
- B. DIMENSIONS ARE IN MILLIMETERS.
- C. DIMENSIONS AND TOLERANCES PER ASME Y14.5M, 1994
- D. TERMINALS 5,6,7 AND 8 ARE TIED TO THE EXPOSED PADDLE

MLP08GrevD

TRADEMARKS

The following are registered and unregistered trademarks Fairchild Semiconductor owns or is authorized to use and is not intended to be an exhaustive list of all such trademarks.

ACE _x TM	FACT Quiet Series TM	OCX TM	SILENT SWITCHER [®]	UniFET TM
ActiveArray TM	GlobalOptoisolator TM	OCXPro TM	SMART START TM	VCX TM
Bottomless TM	GTO TM	OPTOLOGIC [®]	SPM TM	Wire TM
Build it Now TM	HiSeC TM	OPTOPLANAR TM	Stealth TM	
CoolFET TM	I ² C TM	PACMAN TM	SuperFET TM	
CROSSVOLT TM	<i>i-Lo</i> TM	POP TM	SuperSOT TM -3	
DOME TM	ImpliedDisconnect TM	Power247 TM	SuperSOT TM -6	
EcoSPARK TM	IntelliMAX TM	PowerEdge TM	SuperSOT TM -8	
E ² CMOST TM	ISOPLANAR TM	PowerSaver TM	SyncFET TM	
EnSigna TM	LittleFET TM	PowerTrench [®]	TCM TM	
FACT [®]	MICROCOUPLER TM	QFET [®]	TinyBoost TM	
FAST [®]	MicroFET TM	QS TM	TinyBuck TM	
FAST _T TM	MicroPak TM	QT Optoelectronics TM	TinyPWM TM	
FPS TM	MICROWIRE TM	Quiet Series TM	TinyPower TM	
FRFET TM	MSX TM	RapidConfigure TM	TinyLogic [®]	
	MSXPro TM	RapidConnect TM	TINYOPTO TM	
Across the board. Around the world. TM		μSerDes TM	TruTranslation TM	
The Power Franchise [®]		ScalarPump TM	UHC [®]	
Programmable Active Droop TM				

DISCLAIMER

FAIRCHILD SEMICONDUCTOR RESERVES THE RIGHT TO MAKE CHANGES WITHOUT FURTHER NOTICE TO ANY PRODUCTS HEREIN TO IMPROVE RELIABILITY, FUNCTION OR DESIGN. FAIRCHILD DOES NOT ASSUME ANY LIABILITY ARISING OUT OF THE APPLICATION OR USE OF ANY PRODUCT OR CIRCUIT DESCRIBED HEREIN; NEITHER DOES IT CONVEY ANY LICENSE UNDER ITS PATENT RIGHTS, NOR THE RIGHTS OF OTHERS. THESE SPECIFICATIONS DO NOT EXPAND THE TERMS OF FAIRCHILD'S WORLDWIDE TERMS AND CONDITIONS, SPECIFICALLY THE WARRANTY THEREIN, WHICH COVERS THESE PRODUCTS.

LIFE SUPPORT POLICY

FAIRCHILD'S PRODUCTS ARE NOT AUTHORIZED FOR USE AS CRITICAL COMPONENTS IN LIFE SUPPORT DEVICES OR SYSTEMS WITHOUT THE EXPRESS WRITTEN APPROVAL OF FAIRCHILD SEMICONDUCTOR CORPORATION.

As used herein:

1. Life support devices or systems are devices or systems which, (a) are intended for surgical implant into the body, or (b) support or sustain life, or (c) whose failure to perform when properly used in accordance with instructions for use provided in the labeling, can be reasonably expected to result in significant injury to the user.
2. A critical component is any component of a life support device or system whose failure to perform can be reasonably expected to cause the failure of the life support device or system, or to affect its safety or effectiveness.

PRODUCT STATUS DEFINITIONS

Definition of Terms

Datasheet Identification	Product Status	Definition
Advance Information	Formative or In Design	This datasheet contains the design specifications for product development. Specifications may change in any manner without notice.
Preliminary	First Production	This datasheet contains preliminary data, and supplementary data will be published at a later date. Fairchild Semiconductor reserves the right to make changes at any time without notice in order to improve design.
No Identification Needed	Full Production	This datasheet contains final specifications. Fairchild Semiconductor reserves the right to make changes at any time without notice in order to improve design.
Obsolete	Not In Production	This datasheet contains specifications on a product that has been discontinued by Fairchild semiconductor. The datasheet is printed for reference information only.