



Rockwell

RCV288ACi/SVD Integrated V.34 Data/V.17 Fax/Voice/SVD Modem Device Set Family

INTRODUCTION

The Rockwell RC288ACi/SVD integrated data/fax/voice/SVD modem device set supports V.34 data, V.17 fax, voice/audio, digital simultaneous voice and data (DSVD), and full-duplex speakerphone (FDSP) operation over a dial-up telephone line. Models supporting AutoSync and world class are also available. The models available are listed in Table 1.

The modem device set consists of an L39 8-bit microcomputer (MCU) packaged in a 100-pin PQFP (R6723), an RCV288DPi V.34 modem data pump (MDP) packaged in a 68-pin PLCC (R6682), and a DigiTalk™ coprocessor (DTP) packaged in a 100-pin PQFP (R6693).

As a data modem, the modem operates at line speeds to 28800 bps. Error correction (V.42/MNP 2-4) and data compression (V.42 bis/MNP 5) maximize data transfer integrity and boost average data throughput up to 115.2 kbps. Non-error-correcting mode is also supported.

The modem performs error correction and data compression (ECC) in the modem using 32k bytes of external RAM. ECC increases data throughput typically by a factor of four.

As a fax modem, the modem supports Group 3 send and receive rates up to 14400 bps and supports T.30 protocol.

In voice mode, enhanced ADPCM coding and decoding supports efficient digital storage of voice using 2-bit or 4-bit compression and decompression at 7200 bps.

Voice mode also supports business audio and the Integrated Communications System (ICS) program. These features support applications such as digital answering machine, voice annotation, and audio file play/record.

In DSVD mode, the DigiTalk coprocessor (DTP) provides advanced speech compression technology for use in digital simultaneous voice and data (Digital SVD or DSVD) systems. DSVD handset echo cancellation supports handset use through a hybrid. Half-duplex speakerphone (HDSPE) or headset use is also supported in DSVD mode.

Full-duplex speakerphone (FDSP) mode also uses the DigiTalk coprocessor.

AccelerATor kits and reference designs are available to minimize application design time and costs.

PC-based "ConfigurACE™" software allows MCU firmware to be customized to application and country requirements.

FEATURES

- Data modem throughput up to 115.2 kbps
 - V.34, V.FC, V.32 bis, V.32, V.22 bis, V.22A/B, V.23, and V.21; Bell 212A and 103
 - V.42 LAPM and MNP 2-4 error correction
 - V.42 bis and MNP 5 data compression
 - MNP 10 data throughput enhancement
 - MNP 10EC™ enhanced cellular performance
 - Hayes AutoSync (option)
- Fax modem send and receive rates up to 14400 bps
 - V.33, V.17, V.29, V.27 ter, and V.21 channel 2
- Voice mode
 - Enhanced ADPCM compression/decompression
 - Tone detection/generation and call discrimination
 - Concurrent DTMF detection
- Business audio mode using 8-bit monophonic audio data encoding at 11.025 kHz or 7200 Hz
- VoiceView alternating voice and data (AVD)
- Simultaneous voice and data over a telephone line using DSVD-compatible modems
- DSVD 8.5 kbps voice coder/decoder (codec)
 - Robust DSVD timing recovery
 - Handset echo cancellation
 - Voice/silence coding
 - Decoder adaptive postfilter
- Full-duplex speakerphone
 - Acoustic and line echo cancellation
 - Selectable microphone AGC and muting
 - Speaker volume control and muting
 - Auto fallback to pseudo duplex
- World-class operation (option)
 - Call progress, blacklisting, multiple country support
- Communication software compatible AT command sets
- NVRAM directory and stored profiles
- Built-in DTE interfaces with speed up to 115.2 kbps
 - Parallel 16550A UART-compatible interface
 - Serial CCITT V.24 (EIA/TIA-232-E)
- Supports Rockwell PnP ISA Bus Interface Device
- Supports Serial PnP interface per Plug and Play External COM Device Specification, Rev 1.00
- Flow control and speed buffering
- Automatic format/speed sensing to 115.2 kbps
- Serial async data; parallel async data
- Auto dial and auto answer; tone and pulse dialing
- Caller ID and distinctive ring detect
- Device packages
 - MCU (R6723): 100-pin PQFP
 - MDP (R6682): 68-pin PLCC
 - DTP (R6693): 100-pin PQFP
- +5V operation
- Power use (typ.): Operating = 1.75 W; Sleep = 220 mW

Table 1. Modem Models and Functions

Model	Supported Functions			
	Data Modem, Fax Modem, MNP 10/ MNP 10EC, Voice/Audio, VoiceView, DSVD, FDSP, HDSP	AutoSync	W-Class	Country Support
RCV288ACi/SVD	S	-	-	US/Canada
RCV288ACi/A/SVD	S	S	-	US/Canada
RCV288ACiW/SVD	S	S	S	Multiple

Notes:

- Model options:
 - (/A) Hayes AutoSync.
 - W World class support.
- Supported functions (S = Supported; - = Not supported):
 - Fax Class Fax command functions (1 = Fax Class 1; 2 = Fax class 2).
 - MNP 10 MNP 10 data throughput enhancement.
 - MNP 10EC MNP 10EC enhanced cellular.
 - Voice/Audio Voice and business audio command functions.
 - VoiceView VoiceView alternating voice and data (AVD).
 - DSVD Digital Simultaneous voice and data
 - FDSP Full-duplex speakerphone
 - HDSP Half-duplex speakerphone
 - AutoSync Hayes AutoSync using Hayes Synchronous Interface (HSI).
 - W-Class World-class functions supporting multiple country requirements.

V.Fast Class, V.FC, MNP 10EC, RPI+, and ConfigurACE are trademarks of Rockwell International.

MNP is a trademark of Microcom Systems, Inc.

VoiceView is a registered trademark of Radish Communications, Inc.

Hayes is a trademark of Hayes Microcomputer Products, Inc.

TECHNICAL SPECIFICATIONS

GENERAL DESCRIPTION

The modem device set, consisting of separate microcontroller (MCU), modem data pump (MDP), and DigiTalk coprocessor (DTP) devices, provides the processing core for a complete modem design. The OEM adds three crystals, discrete components, and a telephone line/telephone/audio interface circuit to complete the system.

The modem is the full-featured, self-contained data modem/fax modem/voice/audio/SVD solution shown in Figure 1 (serial DTE interface) and Figure 2 (parallel host interface). No external microcontroller for data or fax control functions is required. Dialing, call progress, telephone line interface, voice/audio, and VoiceView functions are supported and controlled through the AT command set. The audio signal interface is illustrated in Figure 3.

Data modem modes perform complete handshake and data rate negotiations. All tone and pattern detection required by the applicable CCITT or Bell standard are supported.

Fax modem modes support Group 3 fax requirements. Fax data transmission and reception performed by the modem is controlled and monitored through the fax EIA-578 Class 1 and fax class 2 command interface. Full HDLC formatting, zero insertion/deletion, and CRC generation/checking is provided.

Both transmit and receive fax data are buffered within the modem. Data transfer to and from the DTE is flow controlled by XON/XOFF.

Modem Data Pump (MDP)

The MDP is a Rockwell RCV288DPi data/fax/voice modem data pump. The crystal frequency is 40.32 MHz.

As a data modem, the MDP can operate in full-duplex, synchronous/asynchronous modes at line rates up to 28800 bps. Using V.34 modulation to optimize modem configuration for line conditions, the MDP can connect at the highest data rate that the channel can support from 28800 bps to 300 bps with automatic fallback. Automode operation in V.34 is provided in accordance with PN3320 and in V.32 bis in accordance with PN2330.

As a fax modem, the MDP fully supports Group 3 facsimile send and receive speeds of 14400, 12000, 9600, 7200, 4800, and 2400 bps.

ADPCM voice processing is performed in the MDP

The RCV288DPi MDP is packaged in a 68-pin PLCC (R6682).

Microcontroller (MCU)

The MCU is a Rockwell L39 microcomputer with interface pins to support DSVD. A pin-compatible L39 MCU without DSVD support is also available.

The MCU performs the command processing and host interface functions. The crystal frequency is 14.7456 MHz or 20.2752 MHz.

The MCU connects to the host via a V.24 (EIA/TIA-232-E) serial interface or a parallel microcomputer bus depending on installed MCU firmware.

The MCU connects to the MDP via dedicated lines and the external bus. The MCU external bus also connects to OEM-supplied ROM (128k bytes) and RAM (32k bytes).

For all models, a 256-byte NVRAM can optionally be connected to the MCU over a dedicated serial interface.

The MCU is packaged in an 100-pin PQFP (R6723).

DigiTalk Coprocessor (DTP)

The DTP is a Rockwell DigiTalk coprocessor. The DTP supports DSVD, FDSP, and HDSP modes. The DTP crystal frequency is 49.92 Mhz. The DTP is packaged in a 100-pin PQFP (R6693).

DSVD mode features a high quality 8.5 kbps voice coder/decoder (codec). The DigiTalk coder includes voice detection and optional voice activated coding, echo cancellation, optional highpass filter, decoder adaptive postfilter, and coder AGC. The robust decoder timing recovery algorithm compensates for clock skew, asynchronous host-to-decoder data transfer delay, intervening variable length data block transmission delay, and loss of encoded speech data. DSVD handset echo cancellation supports handset use through a hybrid. Half-duplex speakerphone (HDSP) or headset use is also supported.

Position independent speakerphone operation supports full-duplex voice conversation using an advanced algorithm that includes both acoustic and line echo cancellation. The host can also easily control speakerphone functions such as mute, automatic gain control (AGC) enable/disable, microphone level, and speaker volume.

MCU Firmware

MCU firmware performs processing of general modem control, command sets, data modem, error correction and data compression (ECC), AutoSync, fax class 1, fax class 2, voice/audio, VoiceView, DSVD, W-class, and DTE/host interface functions according to modem models (see Table 1).

Configurations of the MCU firmware are provided to support parallel host bus interface operation or serial DTE interface operation.

The MCU firmware is provided in object code form for the OEM to program into external ROM. The MCU firmware may also be provided in source code form under a source code addendum license agreement.

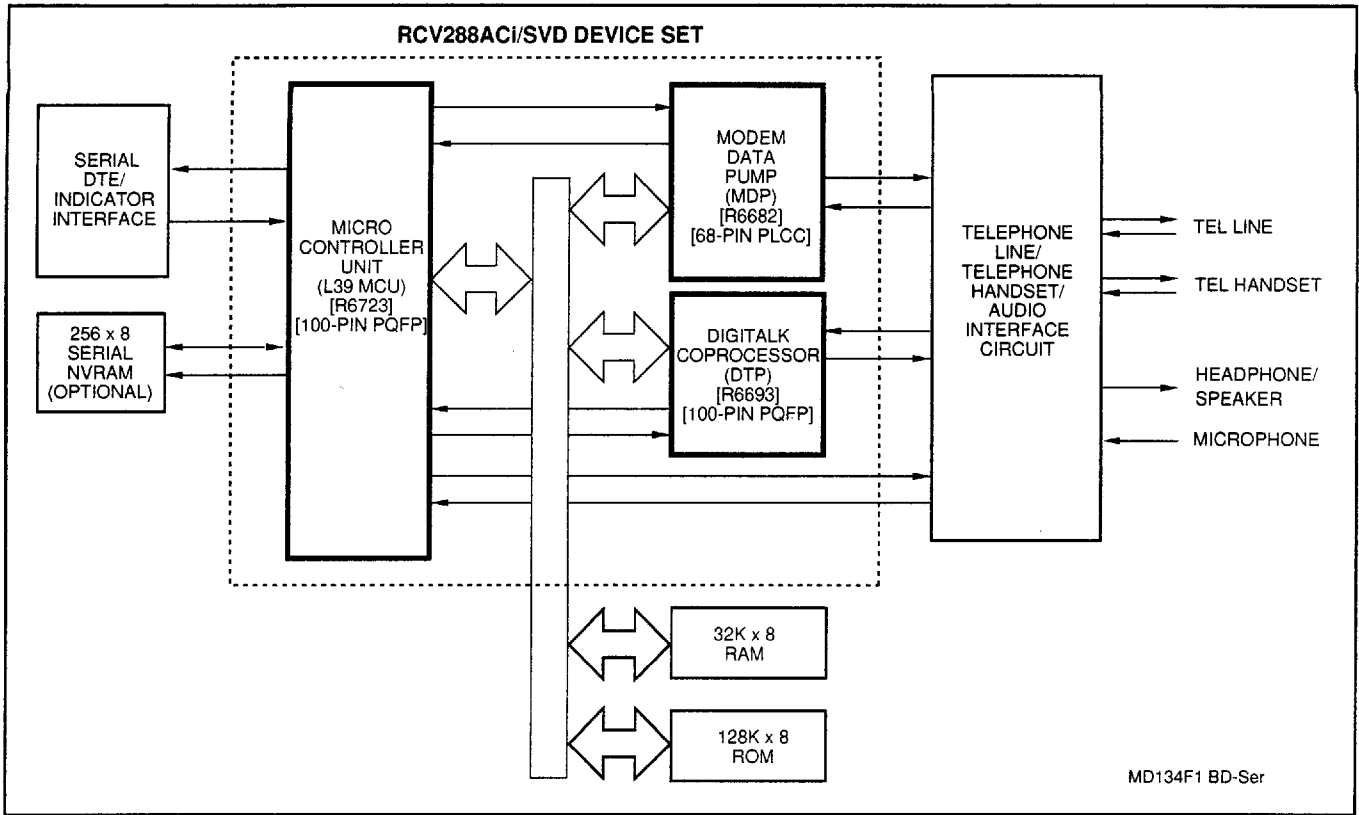

Figure 1. Block Diagram - Serial DTE Interface

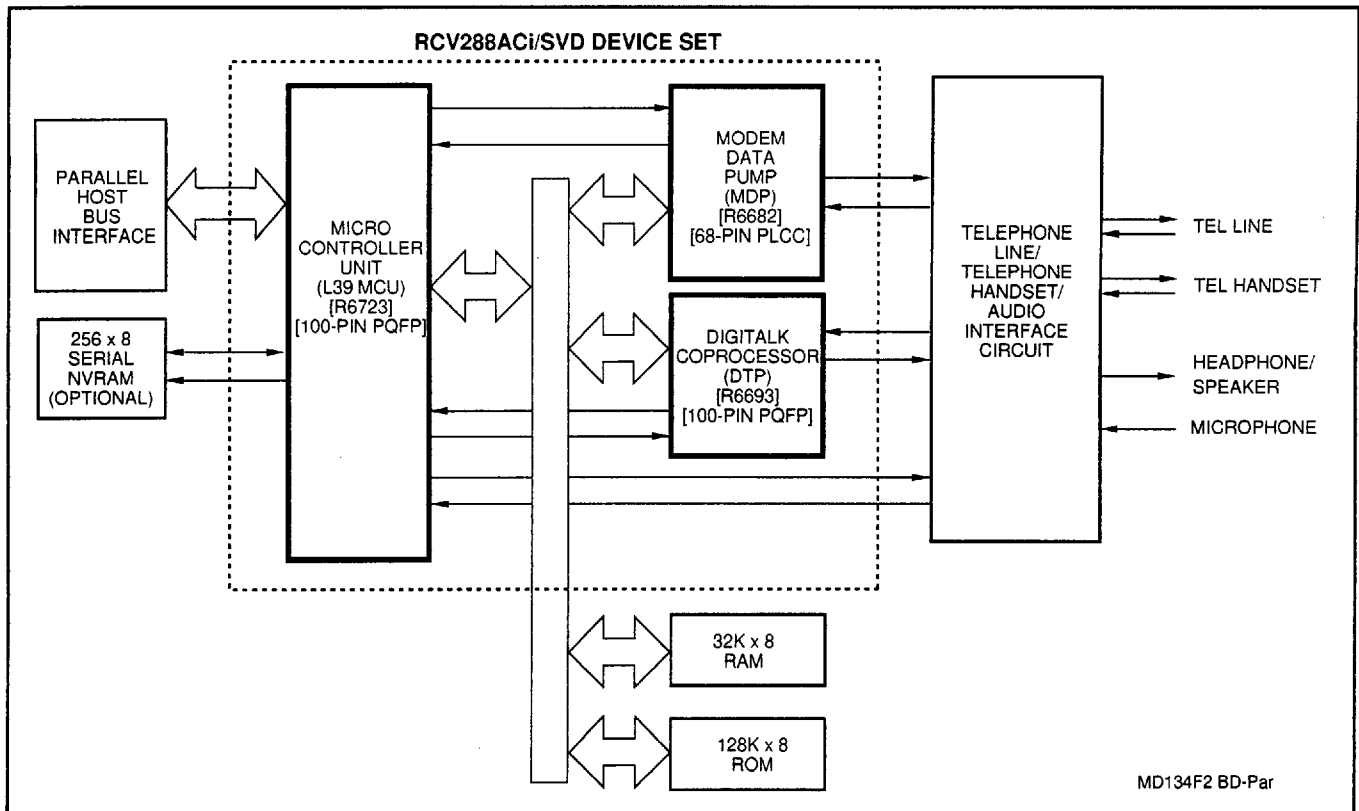

Figure 2. Block Diagram - Parallel Host Interface

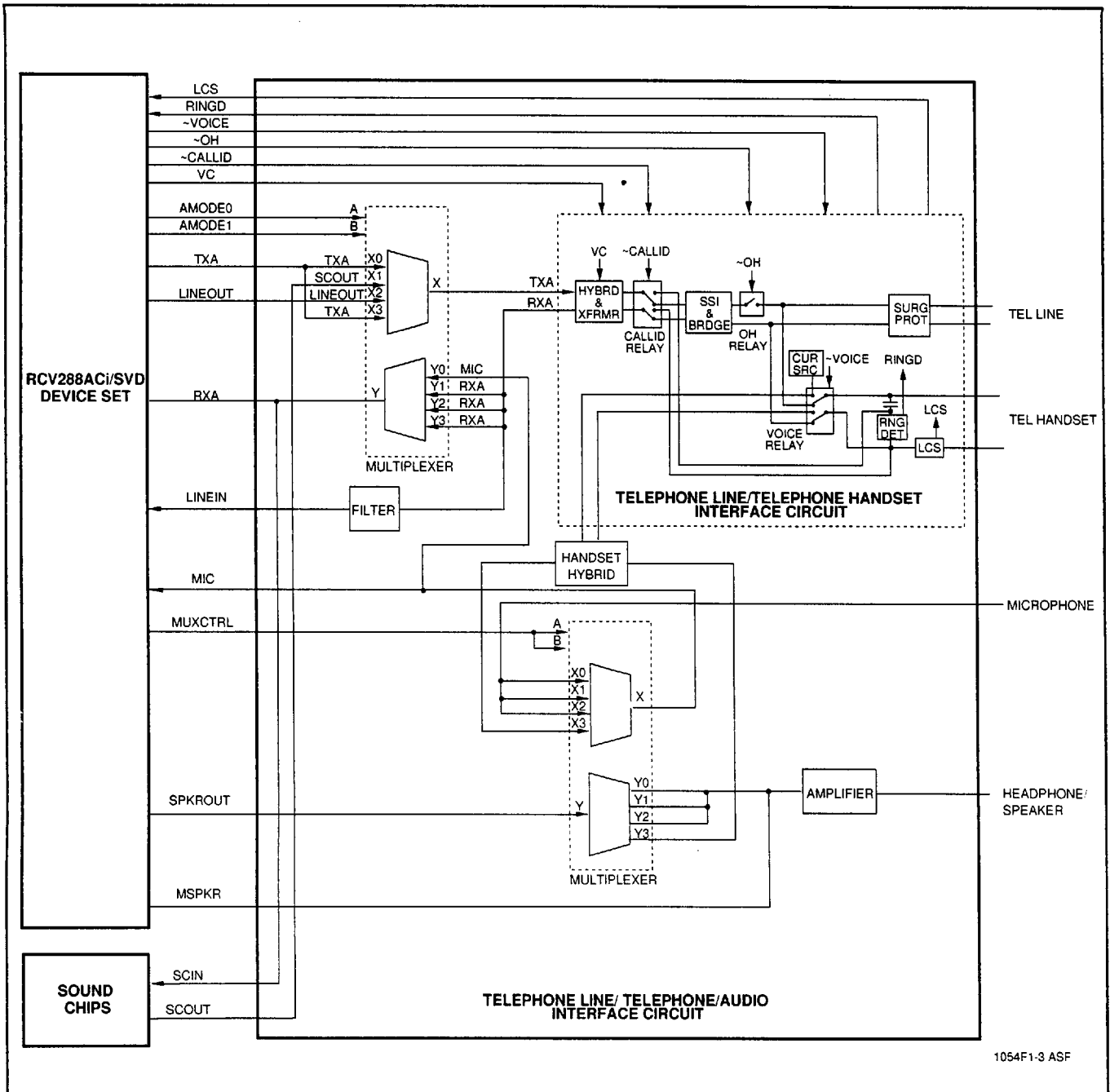

Figure 3. Audio Signal Interface

HARDWARE INTERFACE SIGNALS

The MCU pin assignments with serial DTE interface for the 100-pin PQFP are shown in Figure 4.

The MCU pin assignments with parallel host interface for the 100-pin PQFP are shown in Figure 5.

The MDP pin assignments for the 68-pin PLCC are shown in Figure 6.

The DTP pin assignments for the 100-pin PQFP are shown in Figure 7.

ELECTRICAL AND ENVIRONMENTAL SPECIFICATIONS

The current and power requirements are listed Table 2.

The absolute maximum ratings are listed in Table 3.

ADDITIONAL INFORMATION

Additional information is described in the RCV288ACi/SVD Designer's Guide (Order No. 1054) and in the AT Command Reference Manual (Order No. 1048).

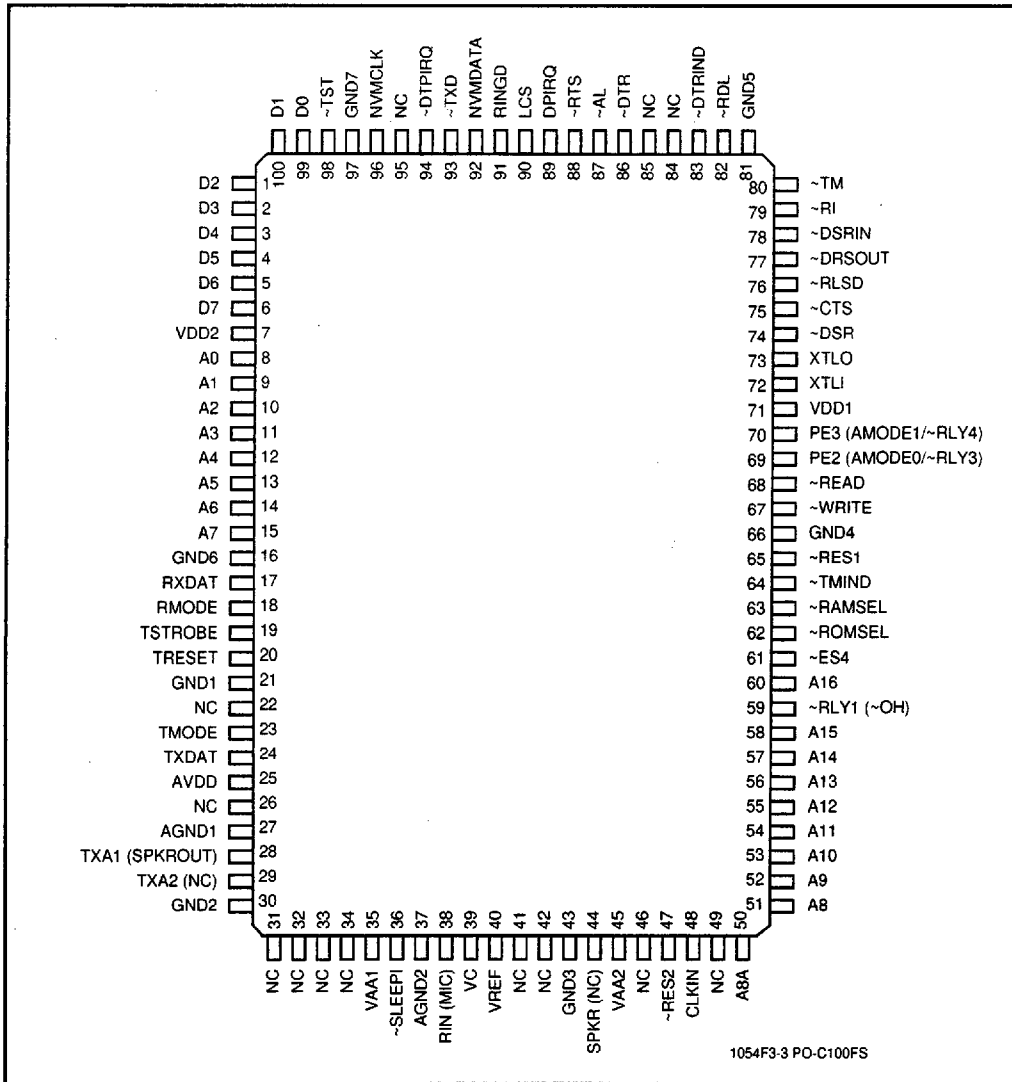

Figure 4. MCU Pin Signals - 100-Pin PQFP - Serial DTE Interface

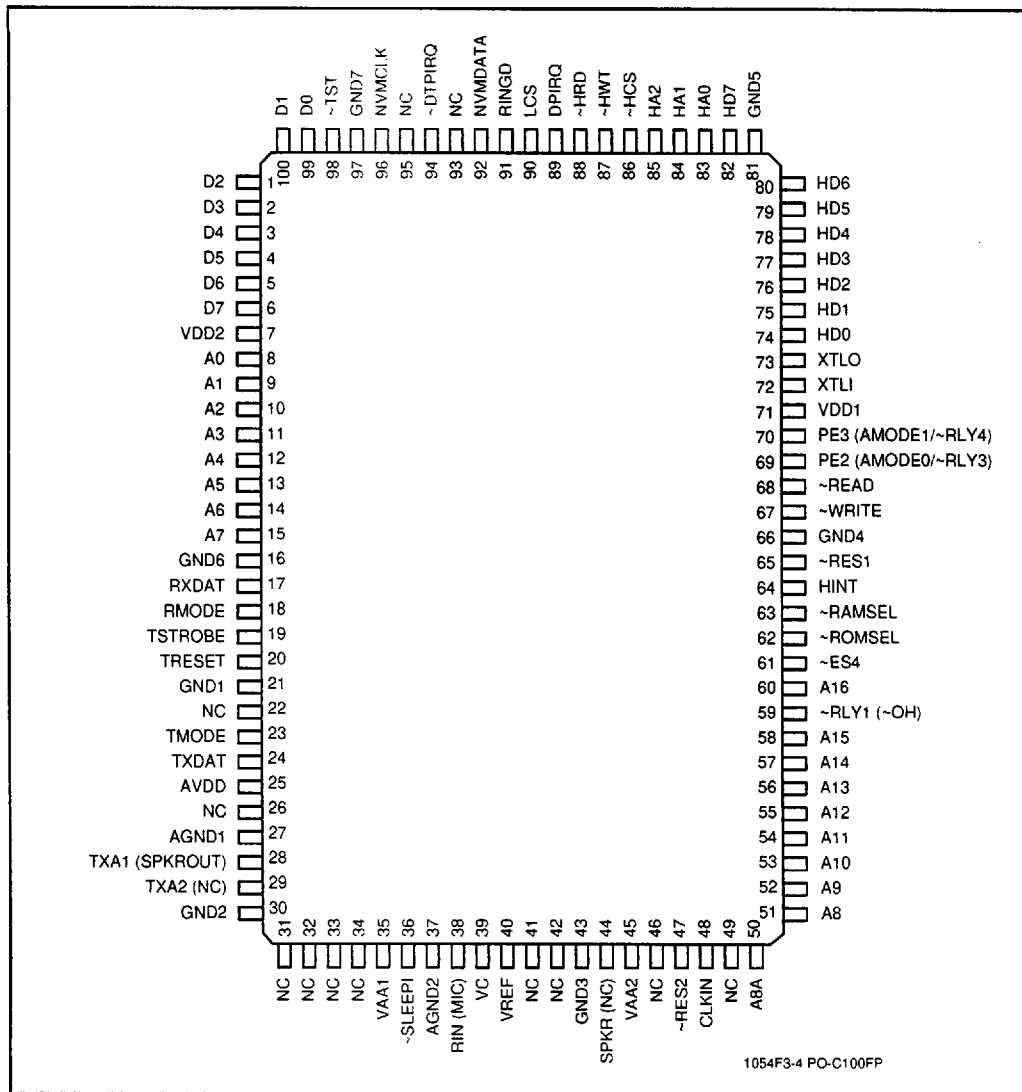

Figure 5. MCU Pin Signals - 100-Pin PQFP - Parallel Host Interface

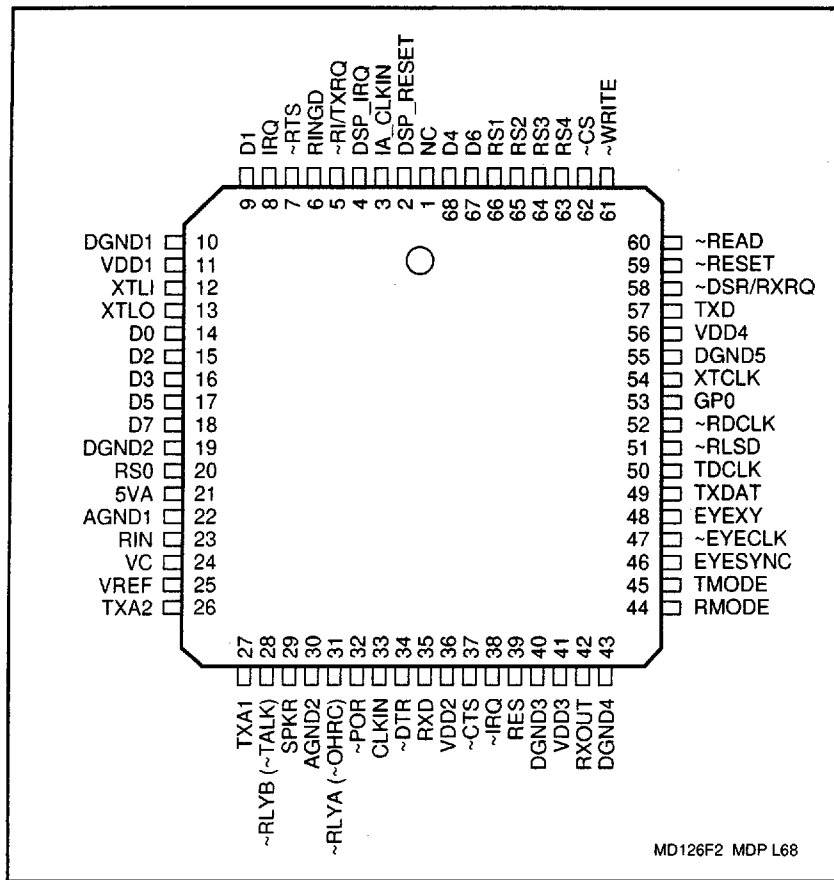

Figure 6. MDP Pin Signals - 68-Pin PLCC

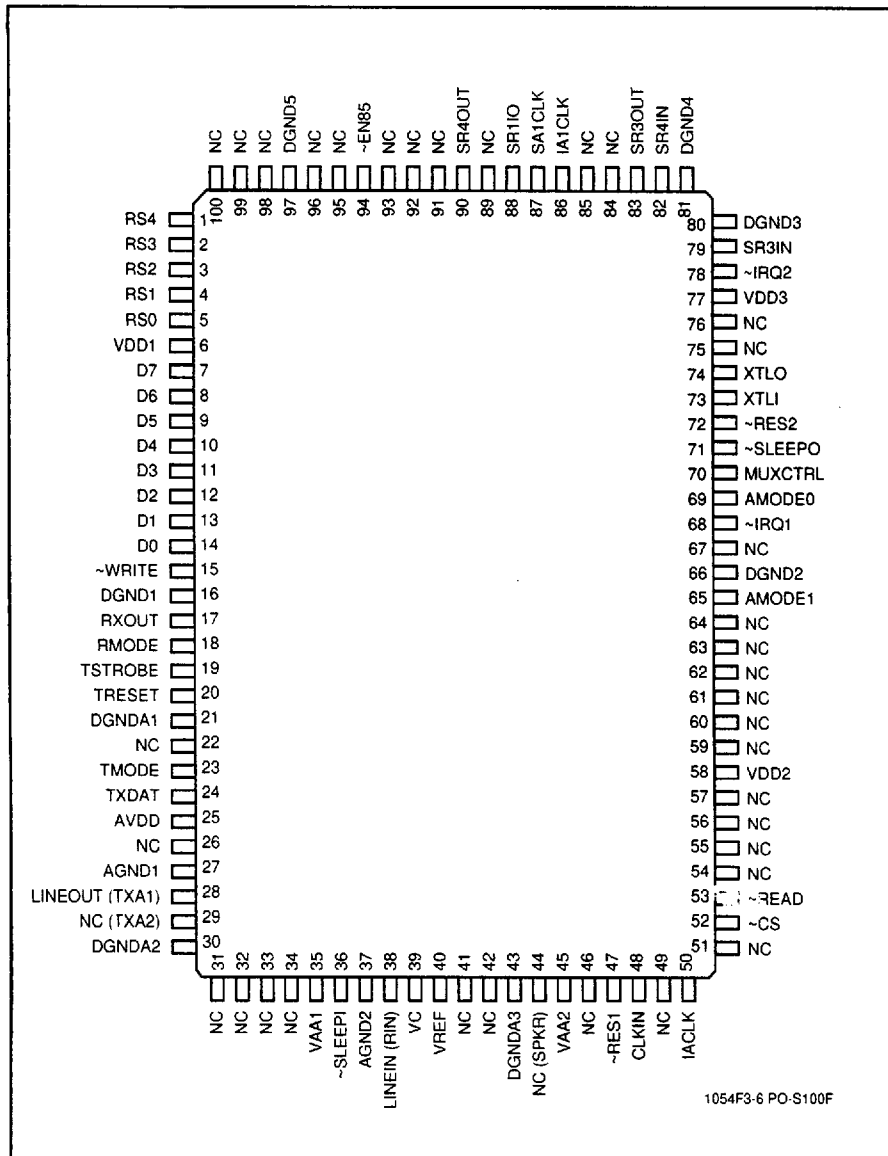

Figure 7. DTP Device Pin Signals - 100-Pin PQFP

Table 2. Current and Power Requirements

Mode	Current (ID)		Power (PD)		Notes
	Typical Current @ 25°C (mA)	Maximum Current @ 0°C (mA)	Typical Power @ 25°C (mW)	Maximum Power @ 0°C (mW)	
MCU (L39)					f _{IN} = 14.7456 MHz
Normal mode	40	47	200	248	
Sleep mode	2.4	3.0	11.8	15.8	
MDP					f _{IN} = 40.32 MHz
Normal mode	196	255	980	1340	
Sleep mode	40.0	52.0	200	273	
DTP					f _{IN} = 49.92 MHz
Normal mode	114	136	570	713	
Sleep mode	2.0	2.5	10.0	13.1	
Total					
Normal mode	350	438	1750	2301	
Sleep mode	44.4	57.5	221.8	301.9	

Notes:
 Test conditions: VCC = 5.0 VDC for typical values; VCC = 5.25 VDC for maximum values.

Table 3. Absolute Maximum Ratings

Parameter	Symbol	Limits	Units
Supply Voltage	V _{DD}	-0.5 to +7.0	V
Input Voltage	V _{IN}	-0.5 to (+5VD + 0.5)	V
Operating Temperature Range	T _A	-0 to +70	°C
Storage Temperature Range	T _{STG}	-55 to +125	°C
Analog Inputs	V _{IN}	-0.3 to (+5VA + 0.3)	V
Voltage Applied to Outputs in High Impedance (Off) State	V _{HZ}	-0.5 to (+5VD + 0.5)	V
DC Input Clamp Current	I _{IK}	±20	mA
DC Output Clamp Current	I _{OK}	±20	mA
Static Discharge Voltage (25°C)	V _{ESD}	±2500	V
Latch-up Current (25°C)	I _{TRIG}	±200	