



Hall Effect IC with Two-Step Lock Protection and Auto-Restart Function

Features:

- Operate from 2.8V to 20V supply voltage.
- On-chip Hall sensor.
- Internal bandgap regulator allows temperature compensated operations and a wide operating voltage range.
- High output sinking capability up to **600mA** for driving large load.
- Available in rugged low profile SOT-25 , SIP-4L packages.
- Built-in protection diode for reverse power supply fault.
- Built-in **2-Step Lock protection** and **auto-restart** function.

General Description:

WSH610 is designed to integrate Hall sensor with complementary output drivers and 2-Step thermal protection circuit together on the same chip. It is carefully designed to protect DC brushless motors to operate on different fault operating condition.

WSH610 can detect whether motor is in locked or operating condition then trigger the low or high temperature protection to protect motor under safety operating zone. This technique allows motors to operate as high temperature as 125°C and keep motor under 80°C low temperature when motor is locked. And all above protection will be disabled when fault condition is removed and motor will be auto-restarted.

WSH610 includes two open collector output drivers, each capable of sinking 600mA current load. An on-chip protection diode is implemented to prevent reverse power fault. Its 2-step protection can replace traditional lock protection and auto restart function but without EMI noise and any external components with much lower cost. The temperature-dependent bias increases the supply voltage of the hall plates and adjusts the switching points to the balance the influence of magnets at higher temperatures. WSH610 are rated for operation on wide temperature range from -20° C to 125°C and voltage ranges from 2.8V to 20V.

Winson reserves the right to make changes to improve reliability or manufacturability.

Pin Descriptions: SOT-25

Name	P/I/O	Pin#	Description
VDD	P	1	Positive Power Supply
Vss	P	2	Ground
None	O	3	No fuction
OUT2	O	4	Output Pin 2
OUT1	O	5	Output Pin 1

Pin Descriptions: SIP-4L

Name	P/I/O	Pin#	Description
Vcc	P	1	Positive Power Supply
OUT1	O	2	Output Pin #1
OUT2	O	3	Output Pin #2
Vss	P	4	Ground

Absolute Maximum Rating (at Ta=25° C)

Supply Voltage	Vcc -----	20V
Output / FG breakdown Voltage	Vout/Vfg -----	25V
Magnetic flux density	B -----	Unlimited
Reverse Protection Voltage	Vr -----	20V
Output Current	Continuous	Ic ----- 450mA
	Lock current	Ih ----- 600mA
	Peak current	Ip ----- 800mA
Operating Temperature Range	Ta -----	(-20°C to +100°C)
Storage Temperature Range	Ts -----	(-65°C to +150°C)
Package Power Dissipation	Pd -----	350mw for SOT-25 500mw for SIP-4L

Electrical Characteristics: (T=+25°C, Vcc=2.8V to 20V)

Characteristic	Symbol	Test Conditions	Min	Typ	Max	Units
Supply Voltage	Vcc	—	2.8	—	20	V
Output Saturation Voltage	Vout(sat)	Vcc=12V, Ic=200mA B > Bop	—	0.15	0.4	V
Output Leakage Current	Ileakage	Vcc=12V, B < Brp	—	<0.1	10	uA
Supply Current	Isupply	Vcc=20V, Output &	—	15	25	mA

Winson reserves the right to make changes to improve reliability or manufacturability.

Function Block:

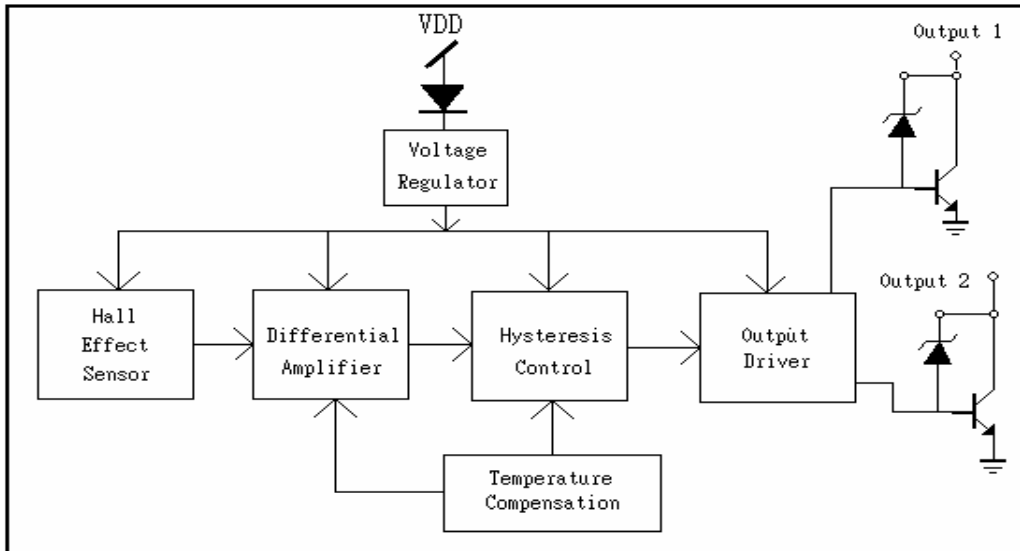

Magnetic Characteristics:

Characteristics	Symbol	Quantity	Ta= -20°C to +100°C			Unit
			Min	Typ.	Max	
Operate Point	Bop	Grade A		25	50	Gauss
		Grade B		30	70	
		Grade C		50	120	
Release Point	Brp	Grade A	-50	-25		Gauss
		Grade B	-70	-30		
		Grade C	-120	-50		
Hysteresis Window	Bop-Brp			50	200	Gauss

Winson reserves the right to make changes to improve reliability or manufacturability.

Operating Current vs. Thermal Protection temperature

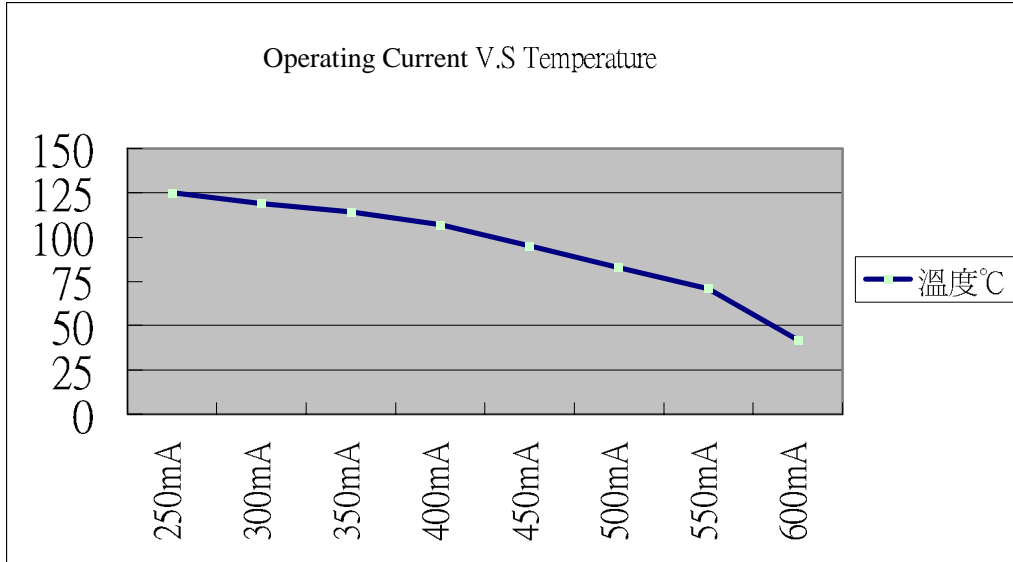

Ordering Information:

<p>SIP- 4L: WSH610-XPAN <input type="checkbox"/></p> <p>SOT-25: WSH610-XPDN <input type="checkbox"/></p> <p style="text-align: center;">└─┬─┘ Elec. Grade</p> <p>N: Non-lead Process</p>	<p>Elec. Grade</p> <p>1: A Grade (50 Gauss)</p> <p>2: B Grade (70 Gauss)</p> <p>3: C Grade (120 Gauss)</p>
---	---

Complementary Output1 vs. Output2

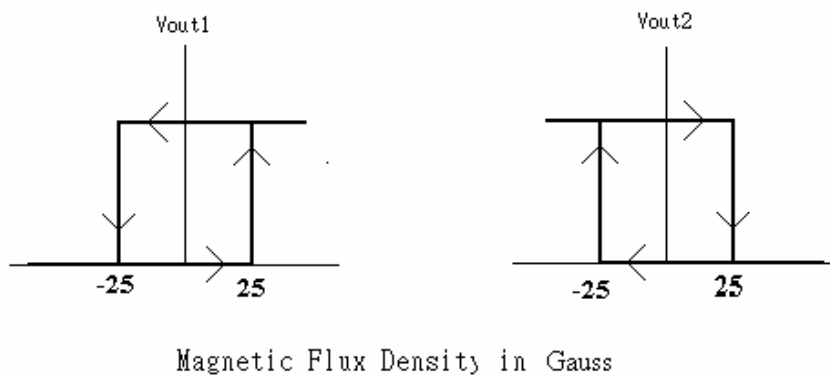

Winson reserves the right to make changes to improve reliability or manufacturability.

Test Circuit:

SIP-4L

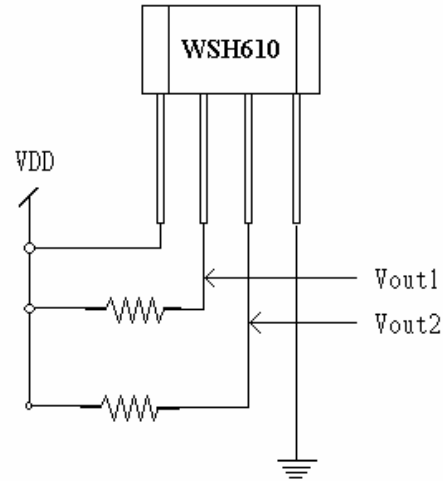

SOT-25

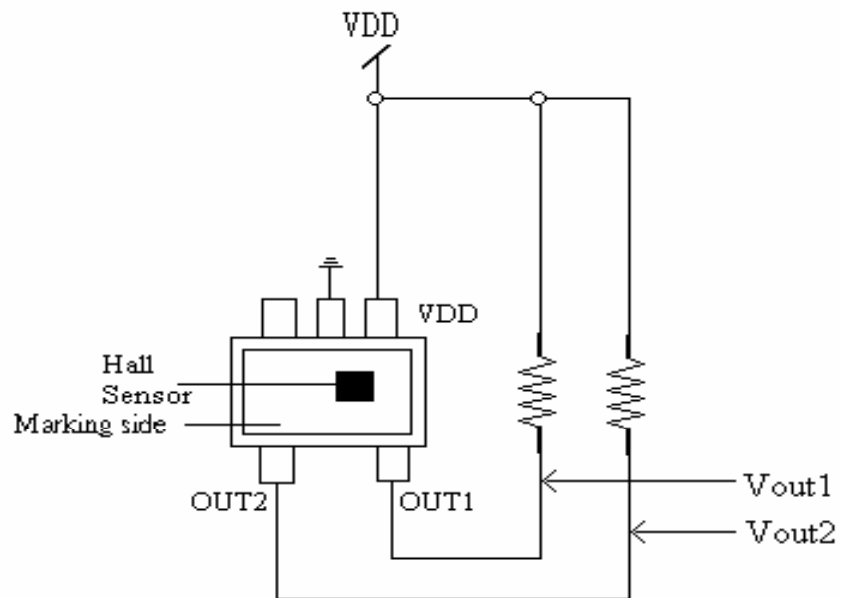

Winson reserves the right to make changes to improve reliability or manufacturability.

Package Information:

SOT-25

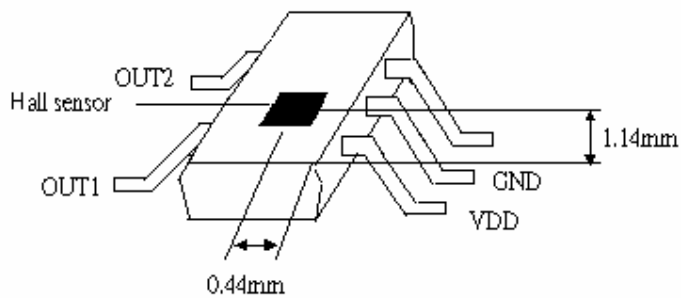
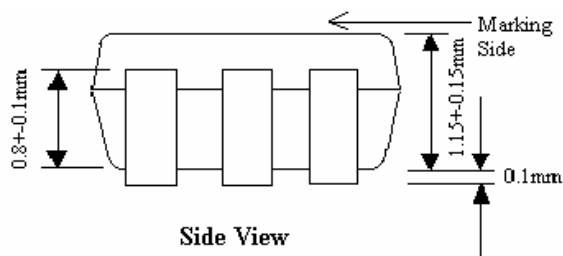
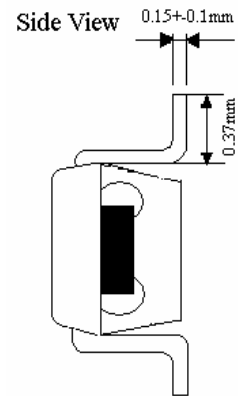
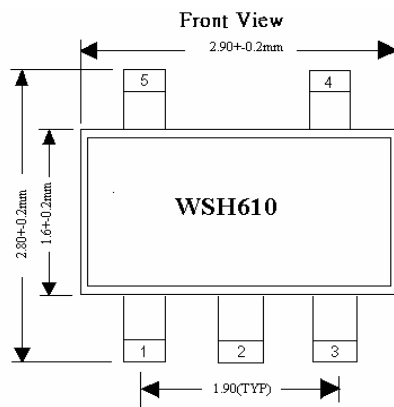

Winson reserves the right to make changes to improve reliability or manufacturability.

SIP-4L

Package Dimension

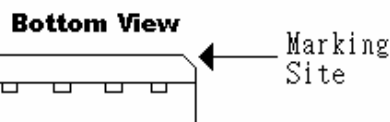
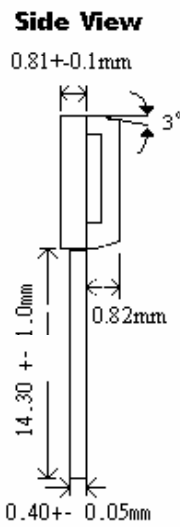
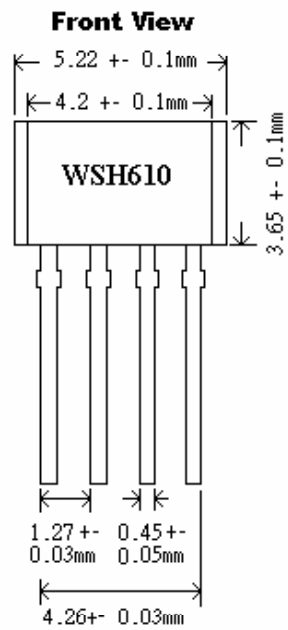
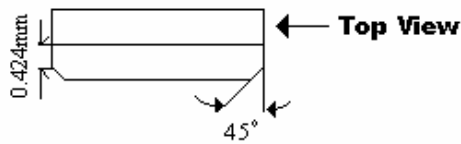

Hall Sensor Location

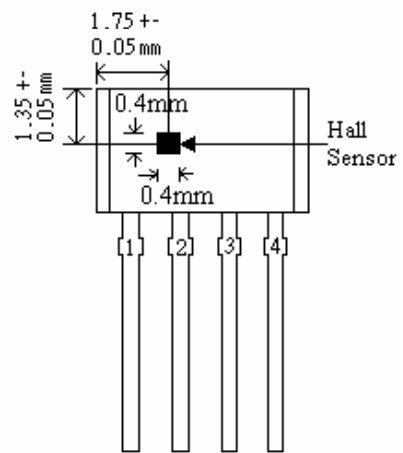

Winson reserves the right to make changes to improve reliability or manufacturability.

Application Circuit:

SOT-25

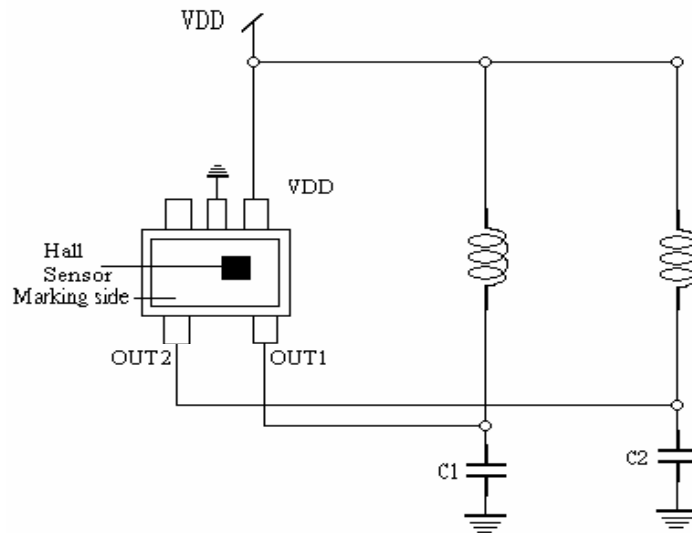

Figure 1.

SIP-4L

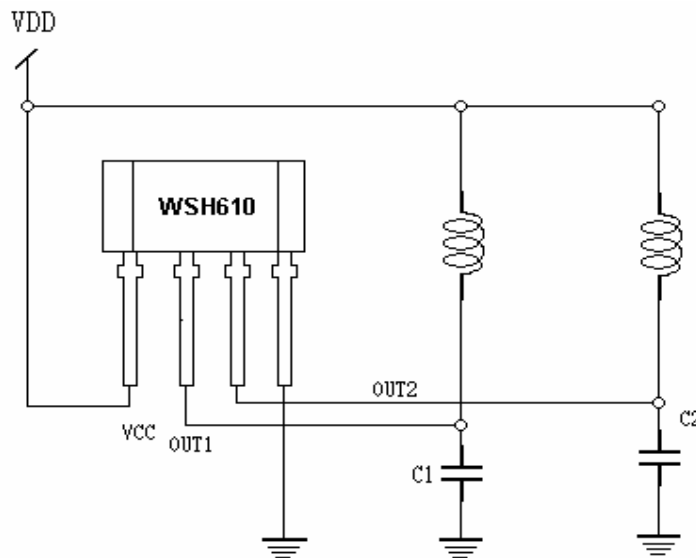

Figure 2.

Winson reserves the right to make changes to improve reliability or manufacturability.