

4 TERMINAL LOW DROP VOLTAGE REGULATOR

The KIA78MR × × Series are Low Drop Voltage Regulator suitable for various electronic equipments. It provides constant voltage power source with TO-220 4 terminal lead full molded PKG. The Regulator has multi function such as over current protection, overheat protection and ON/OFF control.

FEATURES

- 0.5A Output Low Drop Voltage Regulator.
- Built in ON/OFF Control Terminal.
- Built in Over Current Protection, Over Heat Protection Function.

LINE UP

ITEM	OUTPUT VOLTAGE (Typ.)	UNIT
* KIA78MR05PI	5	V
* KIA78MR06PI	6	
* KIA78MR08PI	8	
* KIA78MR09PI	9	
* KIA78MR10PI	10	
* KIA78MR12PI	12	
* KIA78MR15PI	15	

Note) * : Under development

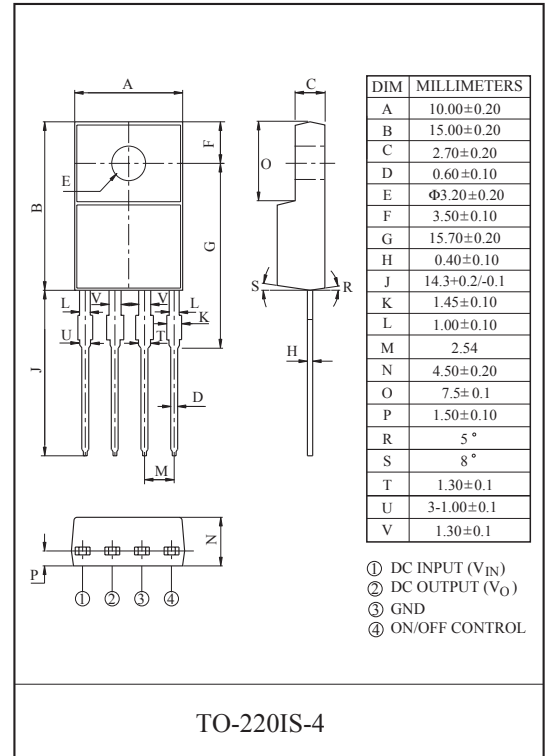

MAXIMUM RATINGS (Ta=25°C)

CHARACTERISTIC	SYMBOL	RATING	UNIT	Remark
Input Voltage	V _{IN}	35	V	-
ON/OFF Control Voltage	V _C	35	V	-
Output Current	I _O	0.5	A	-
Power Dissipation 1	P _{d1}	1.5	W	No heatsink
Power Dissipation 2	P _{d2}	15	W	with heatsink
Junction Temperature	T _j	125	°C	-
Operating Temperature	T _{opr}	-20 ~ 80	°C	-
Storage Temperature	T _{stg}	-30 ~ 125	°C	-
Soldering Temperature (10sec)	T _{sol}	260	°C	-

KIA78MR05PI~KIA78MR15PI

ELECTRICAL CHARACTERISTICS

(Unless otherwise specified, $I_O=0.25A$, $T_a=25^\circ C$, Note1.)

CHARACTERISTIC		SYMBOL	CONDITIONS	MIN.	TYP.	MAX.	UNIT
Output Voltage	KIA78MR05	V_O	-	4.88	5.0	5.12	V
	KIA78MR06		-	5.85	6.0	6.15	
	KIA78MR08		-	7.80	8.0	8.2	
	KIA78MR09		-	8.78	9.0	9.22	
	KIA78MR10		-	9.75	10.0	10.25	
	KIA78MR12		-	11.70	12.0	12.30	
	KIA78MR15		-	14.70	15.0	15.30	
Load Regulation		Reg Load	$I_O=5mA \sim 0.5A$	-	0.1	2.0	%
Line Regulation		Reg Line	(Note2)	-	0.5	2.5	%
Ripple Rejection		$R \cdot R$	-	55	65	-	dB
Drop Out Voltage		V_D	$I_O=0.5A$, (Note3)	-	-	0.5	V
Output ON state for control Voltage		$V_{C(ON)}$	-	2.0	-	-	V
Output ON state for control Current		$I_{C(ON)}$	$V_C=2.7V$	-	-	20	μA
Output OFF state for control Voltage		$V_{C(OFF)}$	-	-	-	0.8	V
Output OFF state for control Current		$I_{C(OFF)}$	$V_C=0.4V$	-	-	-0.4	mA
Quiescent Current		I_Q	$I_O=0$	-	-	10	mA

Note1) V_{IN} of KIA78MR05=7V

- " KIA78MR06=8V
- " KIA78MR08=10V
- " KIA78MR09=15V
- " KIA78MR10=16V
- " KIA78MR12=18V
- " KIA78MR15=21V

Note2) V_{IN} of KIA78MR05=6 ~ 12V

- " KIA78MR06=7 ~ 15V
- " KIA78MR08=9 ~ 25V
- " KIA78MR09=10 ~ 25V
- " KIA78MR10=11 ~ 26V
- " KIA78MR12=13 ~ 29V
- " KIA78MR15=16 ~ 32V

Note3) At $V_{IN}=0.95V_O$

BLOCK DIAGRAM

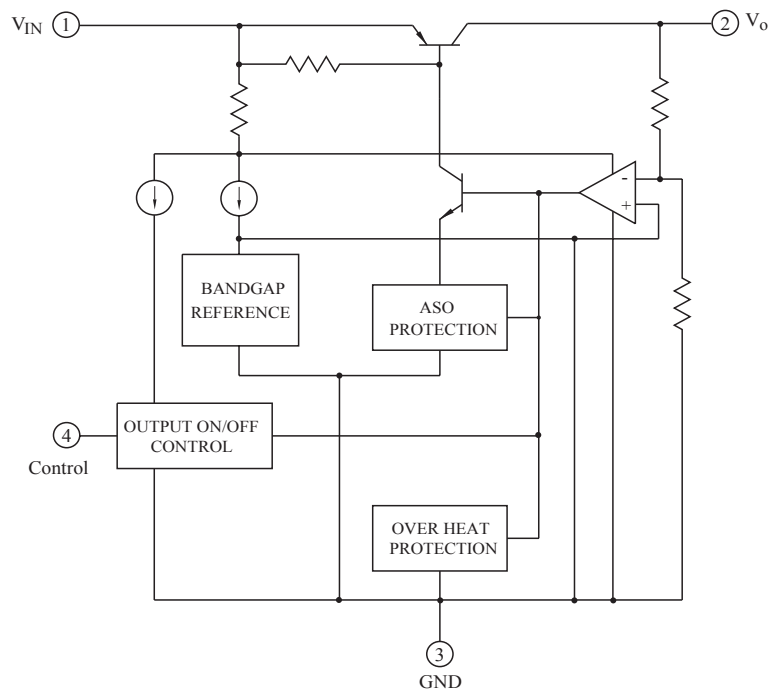

KIA78MR05PI~KIA78MR15PI

Fig. 1 Standard Test Circuit

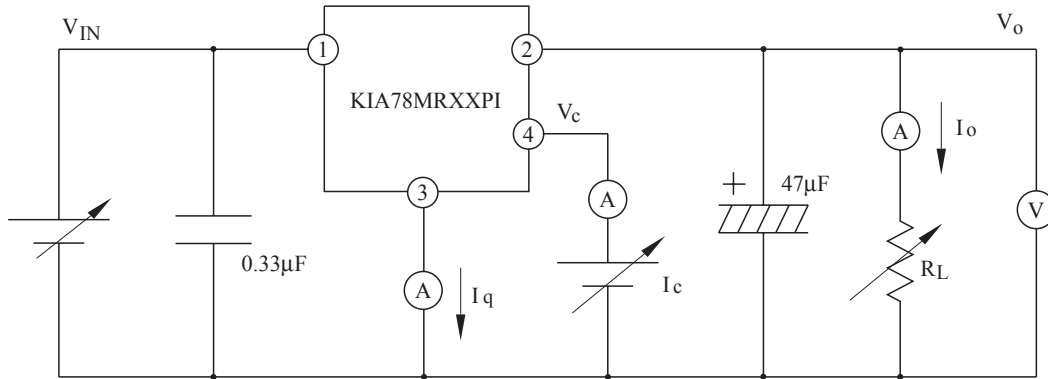

Fig. 1-2 Ripple Rejection Test Circuit

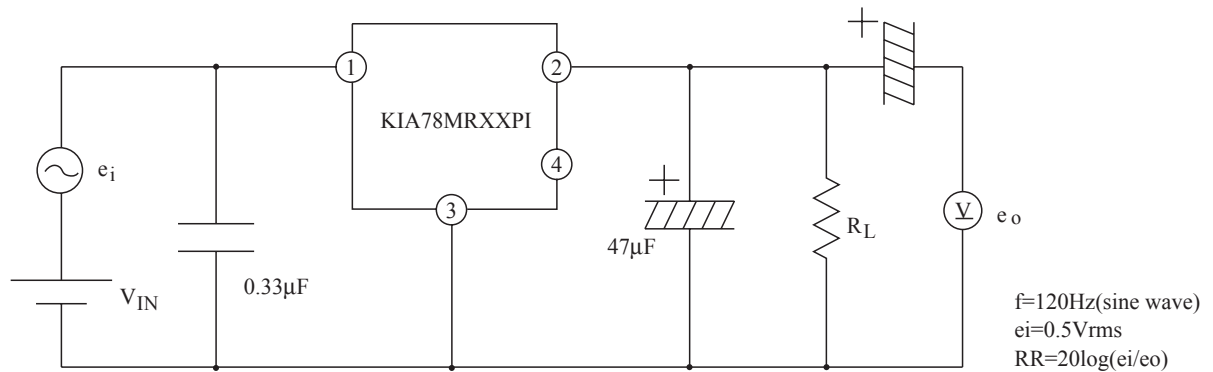
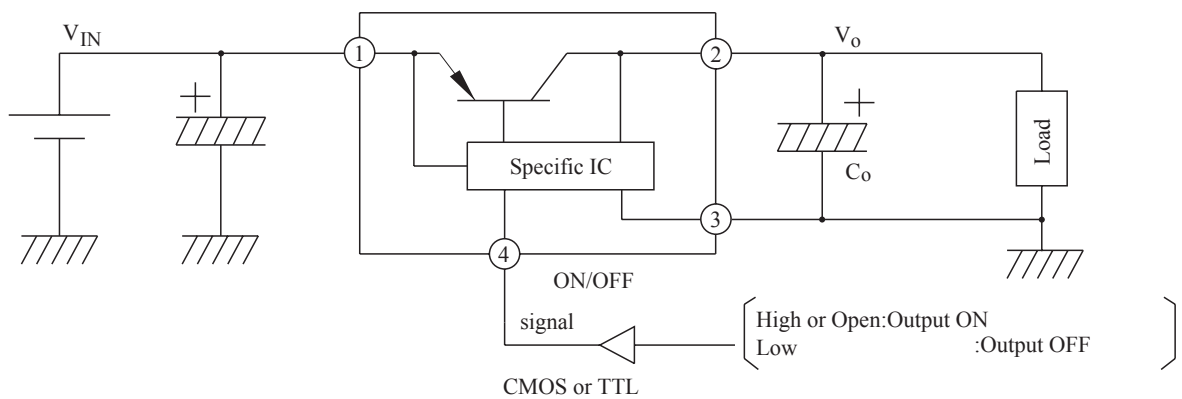
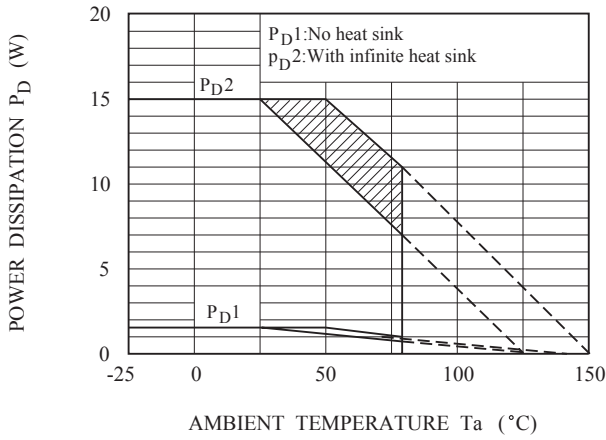

Fig. 2 Application Circuit for Standard



KIA78MR05PI~KIA78MR15PI

Fig.3 $T_a - P_D$



Note) Oblique line portion : Overheat protection may operate in this area.

Fig.4 $I_O - V_O$

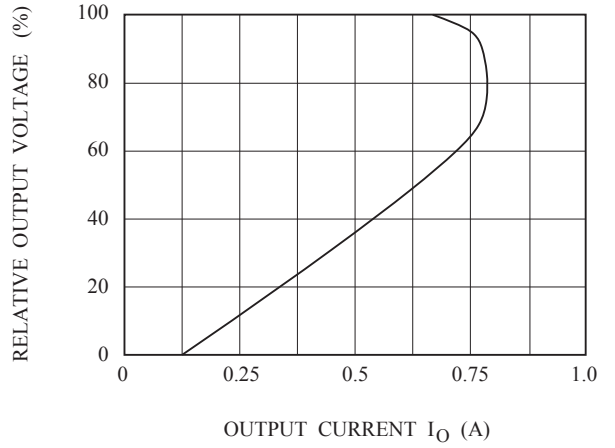

Fig.5-1 $T_j - \Delta V_o$ (KIA78MR05)

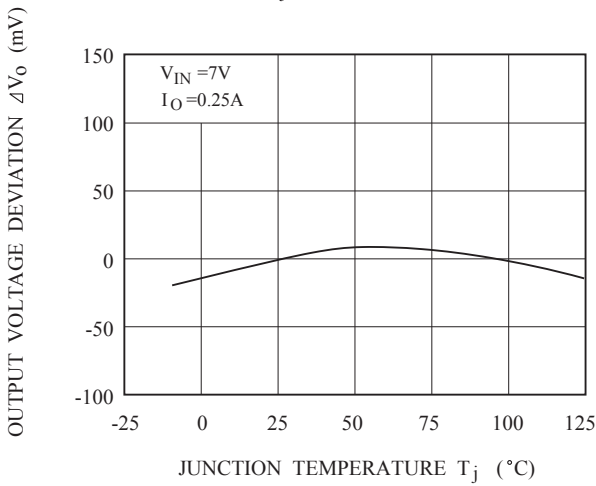

Fig.5-2 $T_j - \Delta V_o$ (KIA78MR06)

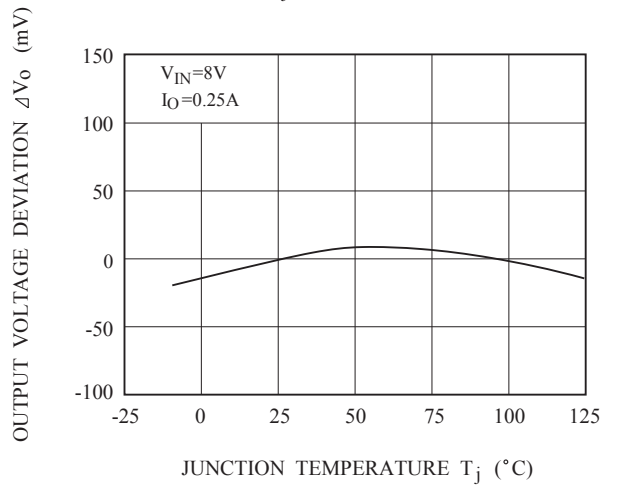

Fig.5-3 $T_j - \Delta V_o$ (KIA78MR08)

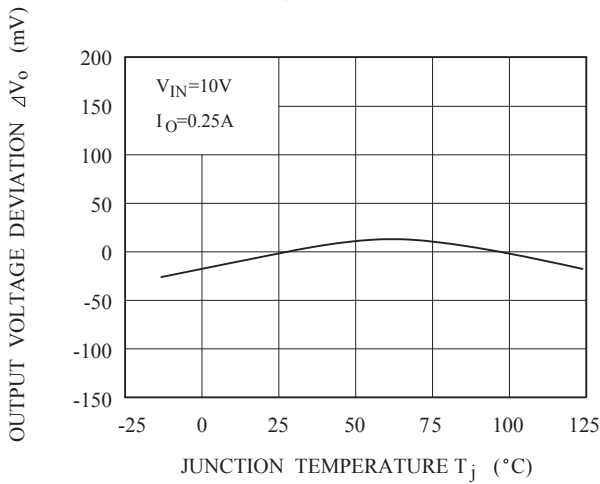
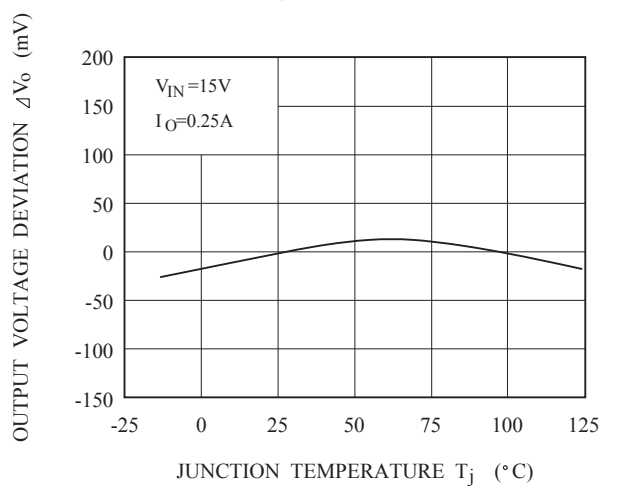

Fig.5-4 $T_j - \Delta V_o$ (KIA78MR09)



KIA78MR05PI~KIA78MR15PI

Fig.5-5 $T_j - \Delta V_o$ (KIA78MR10)

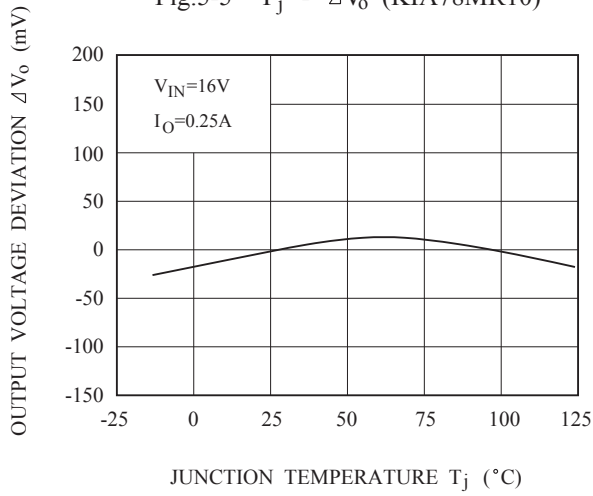

Fig.5-6 $T_j - \Delta V_o$ (KIA78MR12)

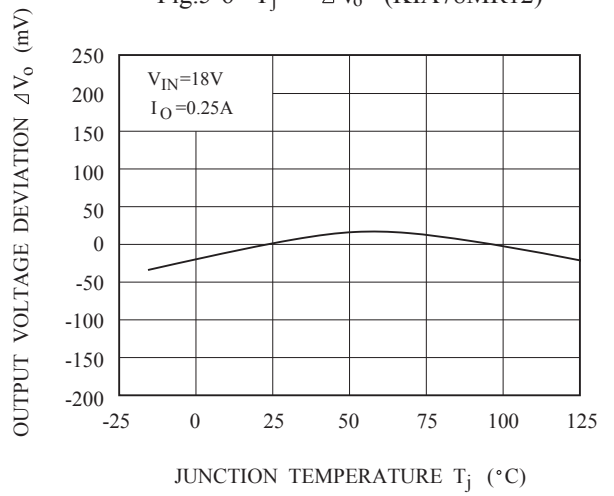

Fig.5-7 $T_j - \Delta V_o$ (KIA78MR15)

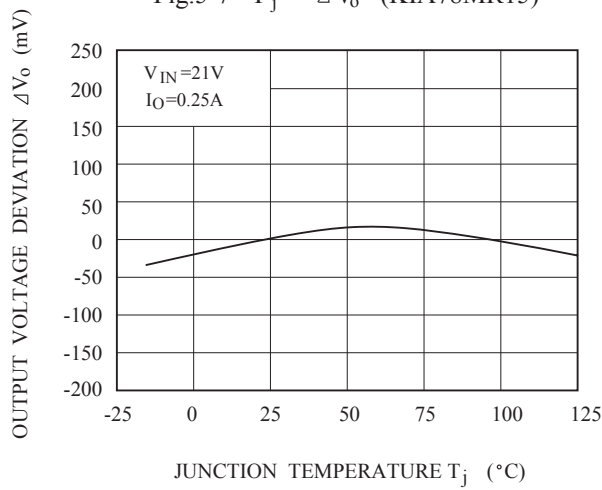

Fig.6-1 $V_{IN} - V_o$ (KIA78MR05)

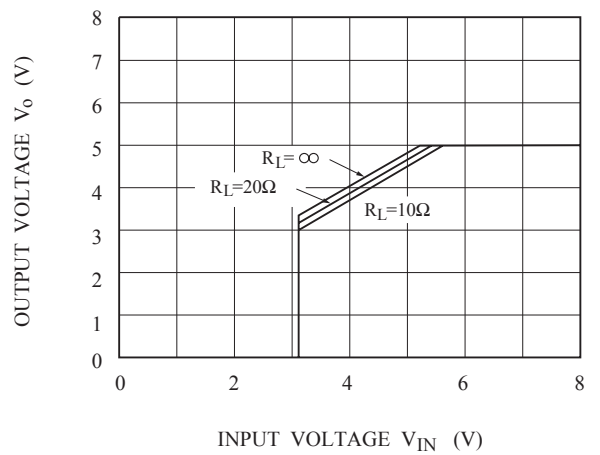

Fig.6-2 $V_{IN} - V_o$ (KIA78MR06)

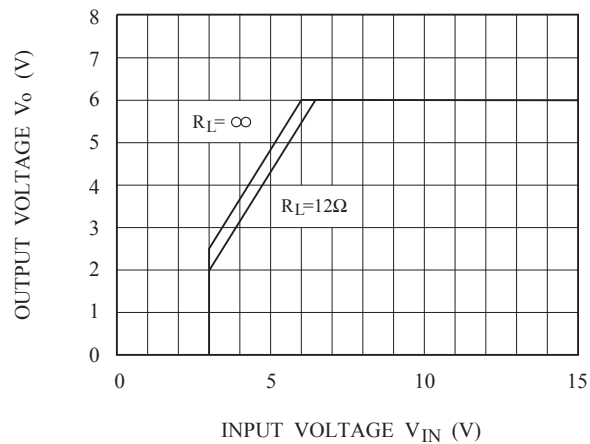
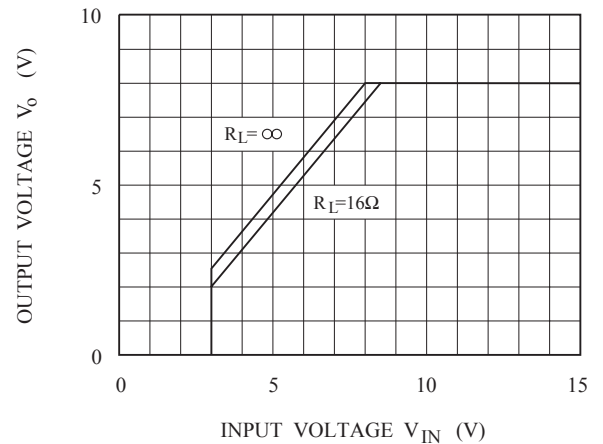

Fig.6-3 $V_{IN} - V_o$ (KIA78MR08)



KIA78MR05PI~KIA78MR15PI

Fig.6-4 $V_{IN} - V_o$ (KIA78MR09)

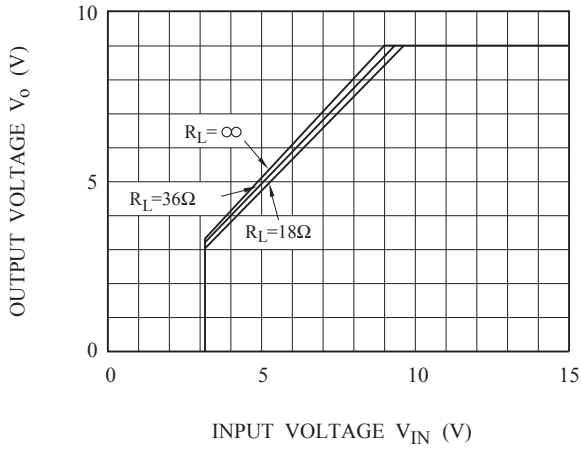

Fig.6-5 $V_{IN} - V_o$ (KIA78MR10)

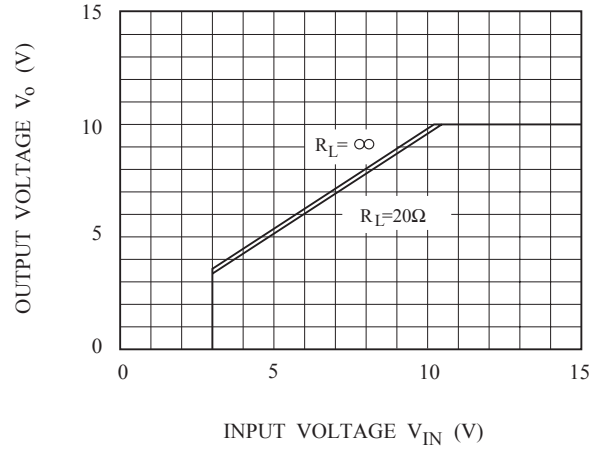

Fig.6-6 $V_{IN} - V_o$ (KIA78MR12)

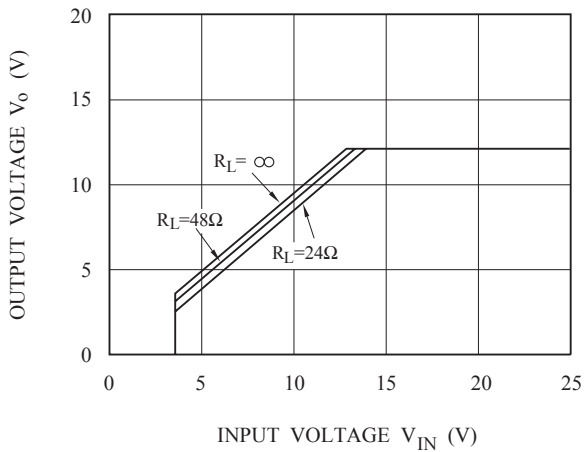

Fig.6-7 $V_{IN} - V_o$ (KIA78MR15)

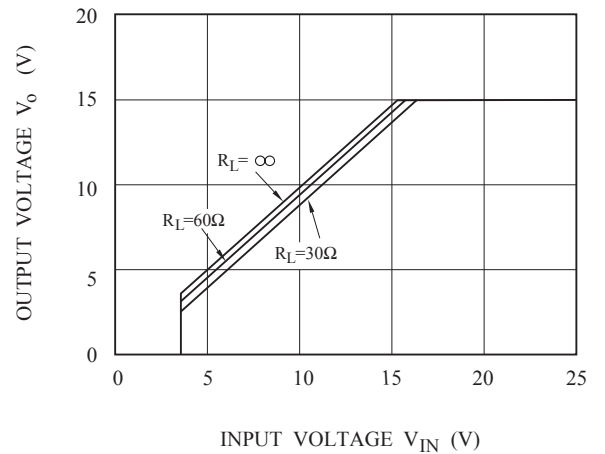

Fig.7-1 $V_{IN} - I_{BIAS}$ (KIA78MR05)

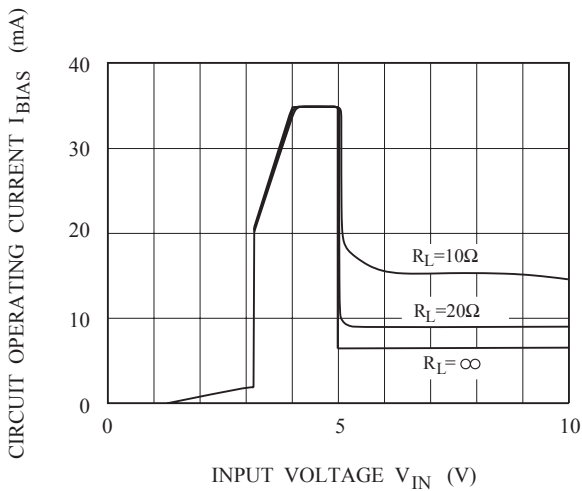
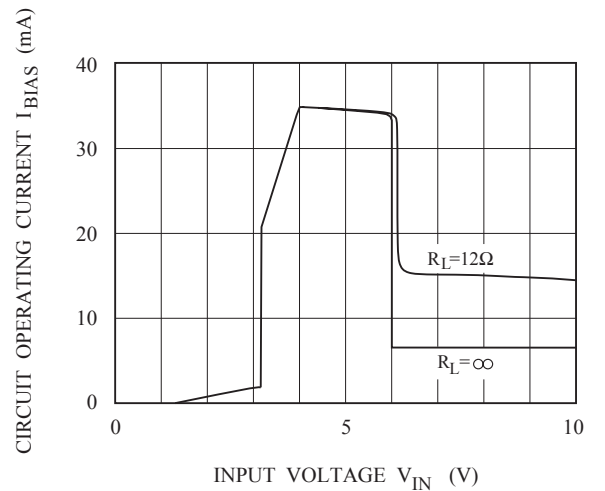

Fig.7-2 $V_{IN} - I_{BIAS}$ (KIA78MR06)



KIA78MR05PI~KIA78MR15PI

Fig.7-3 $V_{IN} - I_{BIAS}$ (KIA78MR08)

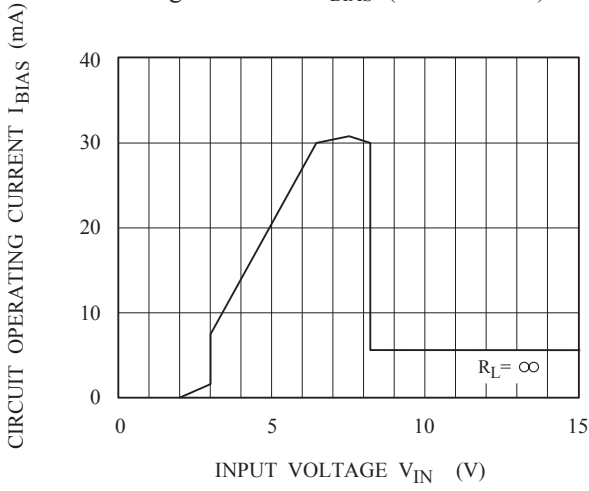

Fig.7-4 $V_{IN} - I_{BIAS}$ (KIA78MR09)

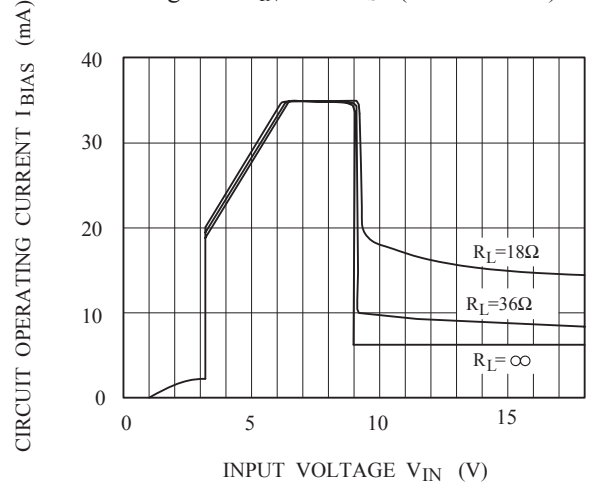

Fig.7-5 $V_{IN} - I_{BIAS}$ (KIA78MR10)

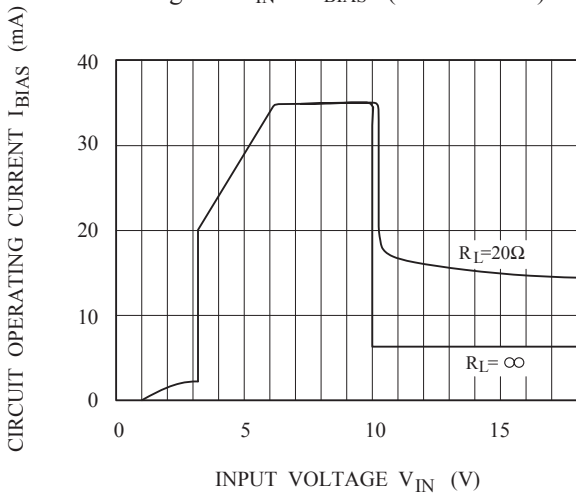

Fig.7-6 $V_{IN} - I_{BIAS}$ (KIA78MR12)

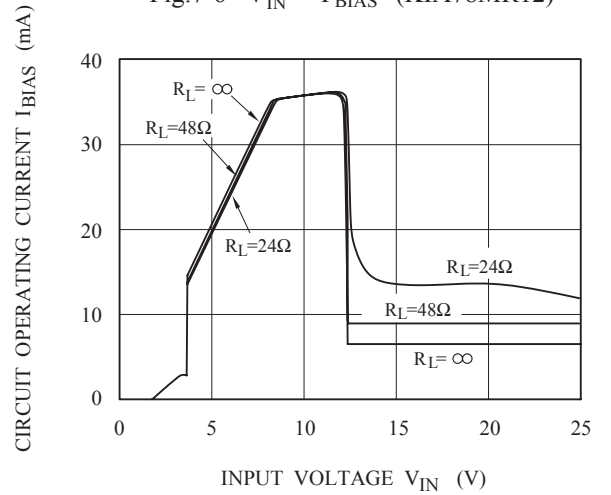

Fig.7-7 $V_{IN} - I_{BIAS}$ (KIA78MR15)

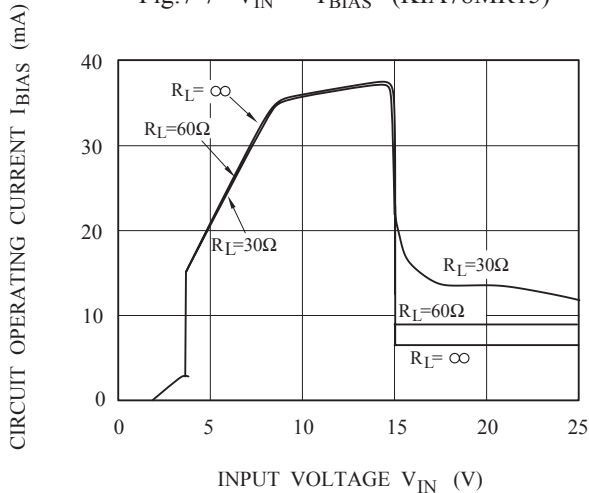
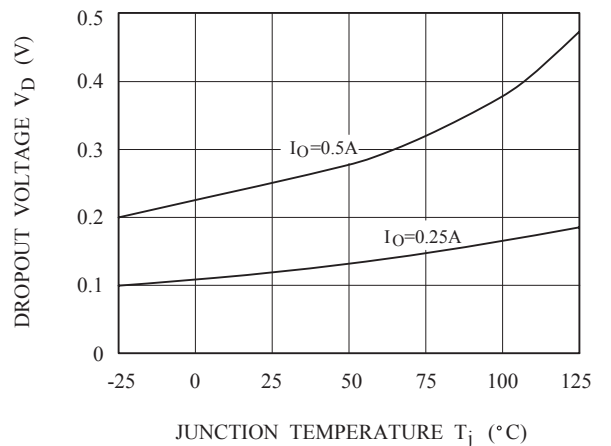

Fig.8 $T_j - V_D$



KIA78MR05PI~KIA78MR15PI

Fig.9 T_j - I_Q

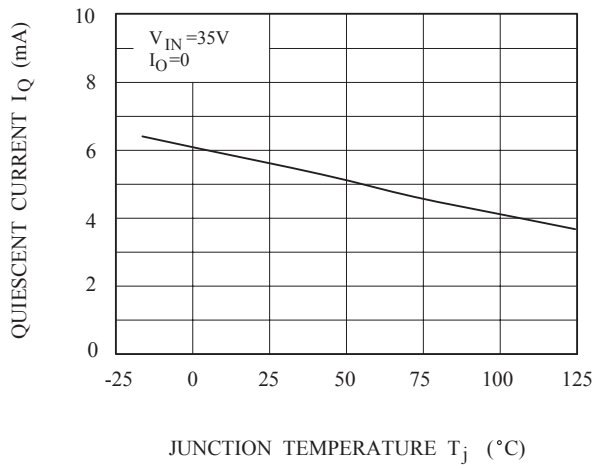

Fig.10-1 f - RR

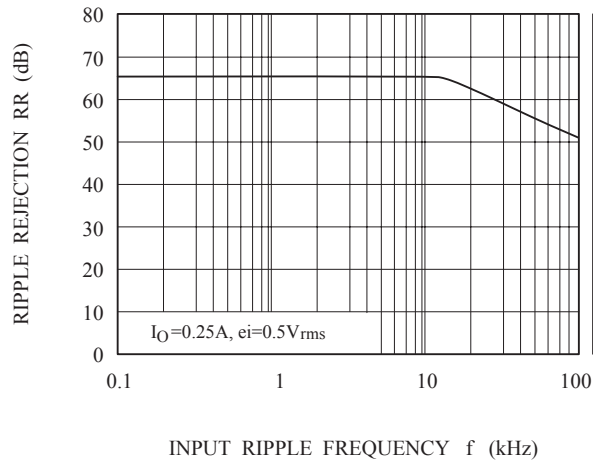

Fig.10-2 I_O - RR

