

EH2545TS-1.900M

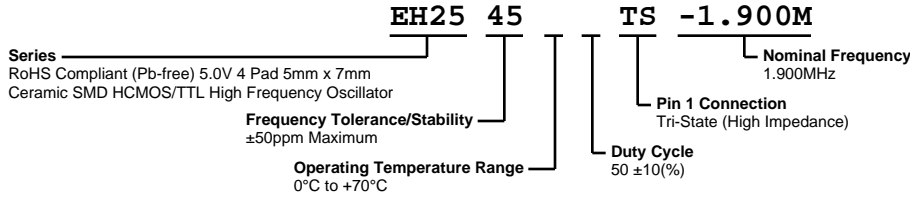

ECLIPTEK[®]
CORPORATION



ELECTRICAL SPECIFICATIONS

Nominal Frequency	1.900MHz
Frequency Tolerance/Stability	±50ppm Maximum (Inclusive of all conditions: Calibration Tolerance at 25°C, Frequency Stability over the Operating Temperature Range, Supply Voltage Change, Output Load Change, First Year Aging at 25°C, Shock, and Vibration)
Aging at 25°C	±5ppm/year Maximum
Operating Temperature Range	0°C to +70°C
Supply Voltage	5.0Vdc ±10%
Input Current	50mA Maximum (No Load)
Output Voltage Logic High (Voh)	2.4Vdc Minimum with TTL Load, Vdd-0.4Vdc Minimum with HCMOS Load (IOH= -16mA)
Output Voltage Logic Low (Vol)	0.4Vdc Maximum with TTL Load, 0.5Vdc Maximum with HCMOS Load (IOH= +16mA)
Rise/Fall Time	6nSec Maximum (Measured at 0.8Vdc to 2.0Vdc with TTL Load; Measured at 20% to 80% of waveform with HCMOS Load)
Duty Cycle	50 ±10(%) (Measured at 1.4Vdc with TTL Load; Measured at 50% of waveform with HCMOS Load)
Load Drive Capability	10TTL Load or 50pF HCMOS Load Maximum
Output Logic Type	CMOS
Pin 1 Connection	Tri-State (High Impedance)
Tri-State Input Voltage (Vih and Vil)	+2.2Vdc Minimum to enable output, +0.8Vdc Maximum to disable output (High Impedance), No Connect to enable output.
Absolute Clock Jitter	±250pSec Maximum, ±100pSec Typical
One Sigma Clock Period Jitter	±50pSec Maximum, ±30pSec Typical
Start Up Time	10mSec Maximum
Storage Temperature Range	-55°C to +125°C

ENVIRONMENTAL & MECHANICAL SPECIFICATIONS

ESD Susceptibility	MIL-STD-883, Method 3015, Class 1, HBM: 1500V
Fine Leak Test	MIL-STD-883, Method 1014, Condition A
Flammability	UL94-V0
Gross Leak Test	MIL-STD-883, Method 1014, Condition C
Mechanical Shock	MIL-STD-883, Method 2002, Condition B
Moisture Resistance	MIL-STD-883, Method 1004
Moisture Sensitivity	J-STD-020, MSL 1
Resistance to Soldering Heat	MIL-STD-202, Method 210, Condition K
Resistance to Solvents	MIL-STD-202, Method 215
Solderability	MIL-STD-883, Method 2003
Temperature Cycling	MIL-STD-883, Method 1010, Condition B
Vibration	MIL-STD-883, Method 2007, Condition A

EH2545TS-1.900M

MECHANICAL DIMENSIONS (all dimensions in millimeters)



PIN	CONNECTION
1	Tri-State
2	Ground
3	Output
4	Supply Voltage

LINE	MARKING
1	ECLIPTEK
2	1.900M
3	XXXXXX XXXXXX=Ecliptek Manufacturing Identifier

Suggested Solder Pad Layout

All Dimensions in Millimeters



All Tolerances are ± 0.1

OUTPUT WAVEFORM & TIMING DIAGRAM



Test Circuit for TTL Output

Output Load Drive Capability	R_L Value (Ohms)	C_L Value (pF)
10TTL	390	15
5TTL	780	15
2TTL	1100	6
10LSTTL	2000	15
1TTL	2200	3

Table 1: R_L Resistance Value and C_L Capacitance Value Vs. Output Load Drive Capability



- Note 1: An external 0.1µF low frequency tantalum bypass capacitor in parallel with a 0.01µF high frequency ceramic bypass capacitor close to the package ground and V_{DD} pin is required.
- Note 2: A low capacitance (<12pF), 10X attenuation factor, high impedance (>10Mohms), and high bandwidth (>300MHz) passive probe is recommended.
- Note 3: Capacitance value C_L includes sum of all probe and fixture capacitance.
- Note 4: Resistance value R_L is shown in Table 1. See applicable specification sheet for 'Load Drive Capability'.
- Note 5: All diodes are MMBD7000, MMBD914, or equivalent.

EH2545TS-1.900M

Test Circuit for CMOS Output

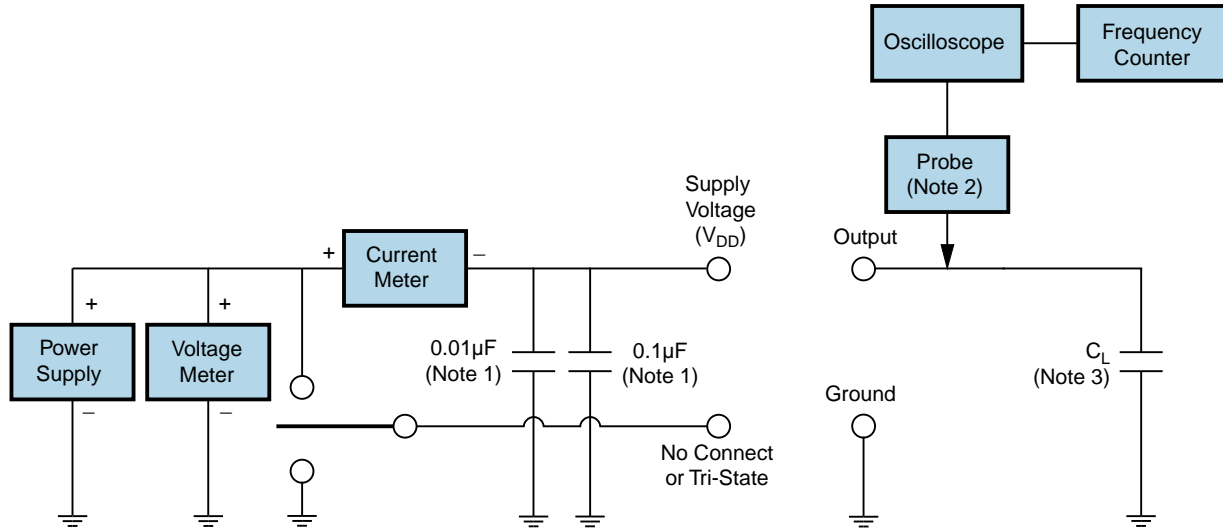

Note 1: An external $0.1\mu\text{F}$ low frequency tantalum bypass capacitor in parallel with a $0.01\mu\text{F}$ high frequency ceramic bypass capacitor close to the package ground and V_{DD} pin is required.

Note 2: A low capacitance ($<12\text{pF}$), 10X attenuation factor, high impedance ($>10\text{Mohms}$), and high bandwidth ($>300\text{MHz}$) passive probe is recommended.

Note 3: Capacitance value C_L includes sum of all probe and fixture capacitance.

Recommended Solder Reflow Methods



High Temperature Infrared/Convection

T_S MAX to T_L (Ramp-up Rate)	3°C/second Maximum
Preheat	
- Temperature Minimum (T_S MIN)	150°C
- Temperature Typical (T_S TYP)	175°C
- Temperature Maximum (T_S MAX)	200°C
- Time (t_s MIN)	60 - 180 Seconds
Ramp-up Rate (T_L to T_P)	3°C/second Maximum
Time Maintained Above:	
- Temperature (T_L)	217°C
- Time (t_L)	60 - 150 Seconds
Peak Temperature (T_P)	260°C Maximum for 10 Seconds Maximum
Target Peak Temperature (T_P Target)	250°C +0/-5°C
Time within 5°C of actual peak (t_p)	20 - 40 seconds
Ramp-down Rate	6°C/second Maximum
Time 25°C to Peak Temperature (t)	8 minutes Maximum
Moisture Sensitivity Level	Level 1
Additional Notes	Temperatures shown are applied to body of device.

Recommended Solder Reflow Methods



Low Temperature Infrared/Convection 240°C

T_s MAX to T_L (Ramp-up Rate)	5°C/second Maximum
Preheat	
- Temperature Minimum (T _s MIN)	N/A
- Temperature Typical (T _s TYP)	150°C
- Temperature Maximum (T _s MAX)	N/A
- Time (t _s MIN)	60 - 120 Seconds
Ramp-up Rate (T_L to T_p)	5°C/second Maximum
Time Maintained Above:	
- Temperature (T _L)	150°C
- Time (t _L)	200 Seconds Maximum
Peak Temperature (T_p)	240°C Maximum
Target Peak Temperature (T_p Target)	240°C Maximum 1 Time / 230°C Maximum 2 Times
Time within 5°C of actual peak (t_p)	10 seconds Maximum 2 Times / 80 seconds Maximum 1 Time
Ramp-down Rate	5°C/second Maximum
Time 25°C to Peak Temperature (t)	N/A
Moisture Sensitivity Level	Level 1
Additional Notes	Temperatures shown are applied to body of device.

Low Temperature Manual Soldering

185°C Maximum for 10 seconds Maximum, 2 times Maximum. (Temperatures shown are applied to body of device.)

High Temperature Manual Soldering

260°C Maximum for 5 seconds Maximum, 2 times Maximum. (Temperatures shown are applied to body of device.)