

HIGH VOLTAGE FAST SWITCHING NPN POWER TRANSISTOR**APT13005****General Description**

The APT13005 series are high voltage, high speed, high efficiency switching transistor, and it is specially designed for off-line switch mode power supplies with low output power.

The APT13005 series is available in TO-220-3, TO-220-3(2), and TO-220F-3 packages.

Features

- High Switching Speed
- High Collector-Emitter Voltage: 700V
- Low Cost
- High Efficiency

Applications

- Battery Chargers for Mobile Phone
- Power Supply for DVD/STB

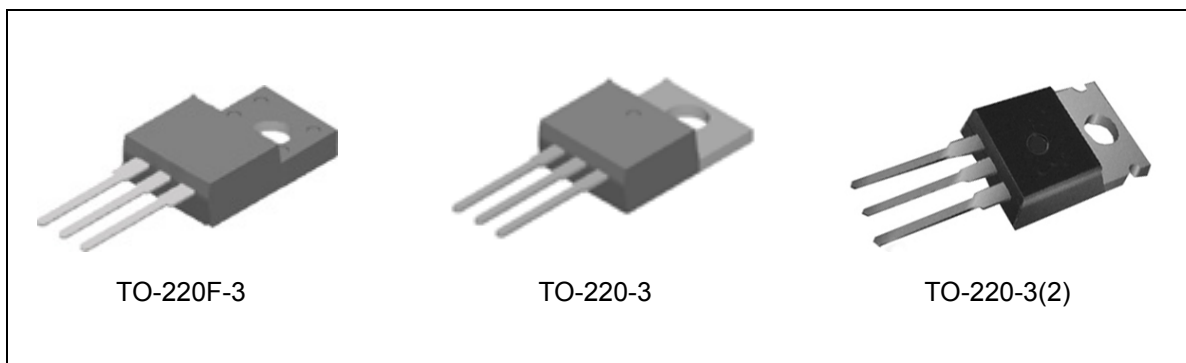

Figure 1. Package Types of APT13005

Pin Configuration

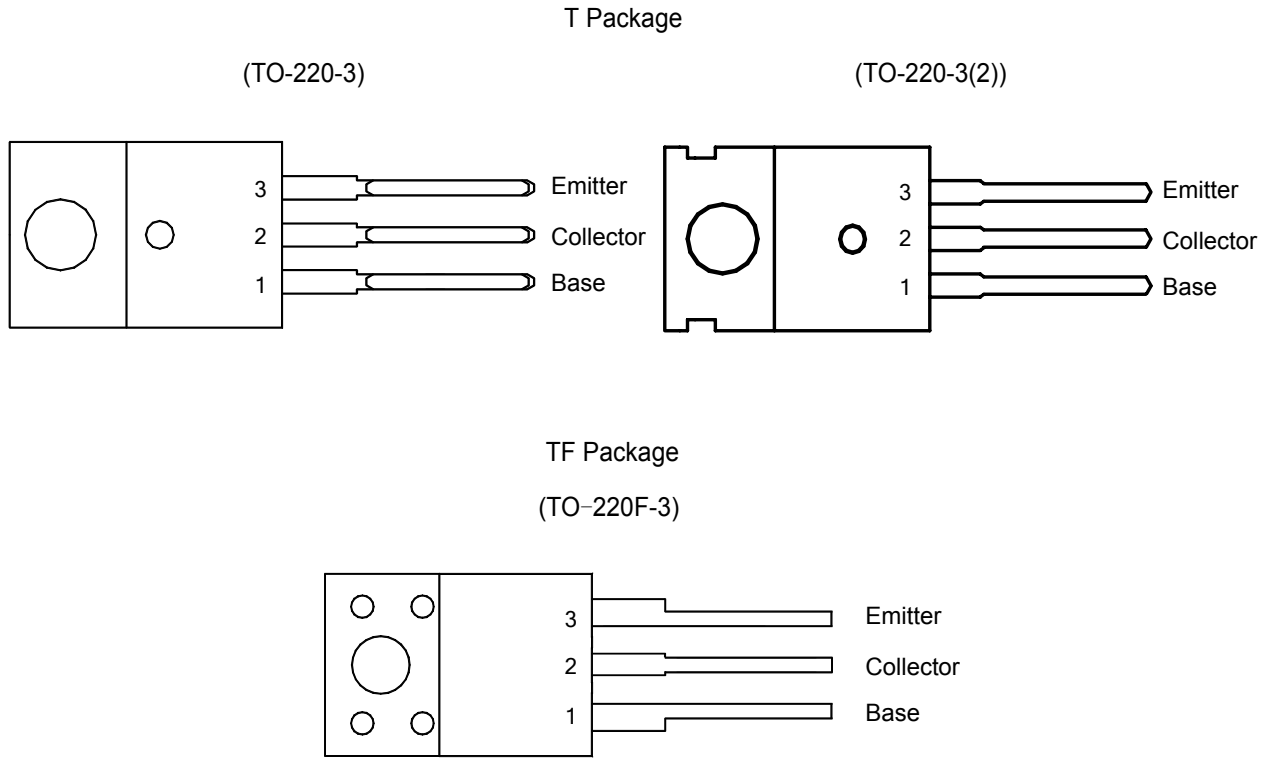

Figure 2. Pin Configuration of APT13005(front view)

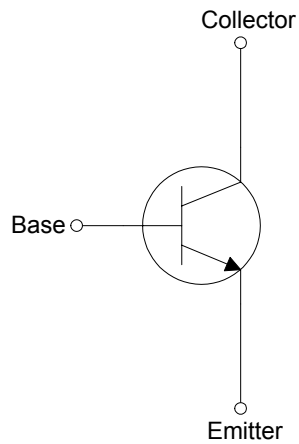

Figure 3. Internal Structure of APT13005



HIGH VOLTAGE FAST SWITCHING NPN POWER TRANSISTOR

APT13005

Ordering Information

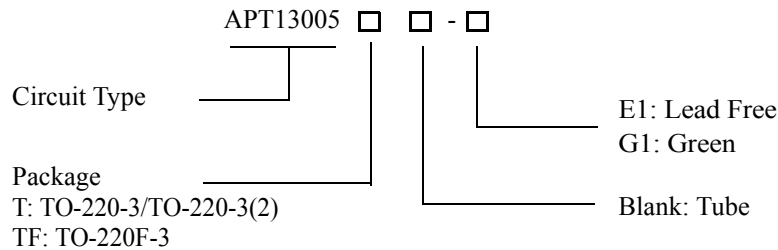

Package	Part Number		Marking ID		Packing Type
	Lead Free	Green	Lead Free	Green	
TO-220-3/ TO-220-3(2)	APT13005T-E1	APT13005T-G1	APT13005T-E1	APT13005T-G1	Tube
TO-220F-3	APT13005TF-E1	APT13005TF-G1	APT13005TF-E1	APT13005TF-G1	Tube

BCD Semiconductor's Pb-free products, as designated with "E1" suffix in the part number, are RoHS compliant. Products with "G1" suffix are available in green packages.

Absolute Maximum Ratings (Note 1)

Parameter	Symbol	Value	Unit
Collector-Emitter Voltage ($V_{BE}=0$)	V_{CES}	700	V
Collector-Emitter Voltage ($I_B=0$)	V_{CEO}	450	V
Emitter-Base Breakdown Voltage ($I_C=0$)	V_{EBO}	9	V
Collector Current	I_C	4	A
Collector Peak Current	I_{CM}	8	A
Base Current	I_B	2	A
Base Peak Current	I_{BM}	4	A
Power Dissipation, $T_C=25^\circ\text{C}$	TO-220-3/ TO-220-3 (2)	75	W
	TO-220F-3	28	
Operating Junction Temperature		150	$^\circ\text{C}$
Storage Temperature Range		-65 to 150	$^\circ\text{C}$

Note 1: Stresses greater than those listed under "Absolute Maximum Ratings" may cause permanent damage to the device. These are stress ratings only, and functional operation of the device at these or any other conditions beyond those indicated under "Recommended Operating Conditions" is not implied. Exposure to "Absolute Maximum Ratings" for extended periods may affect device reliability.

**HIGH VOLTAGE FAST SWITCHING NPN POWER TRANSISTOR****APT13005****Thermal Characteristics**

Parameter	Symbol	Condition		Value	Unit
Maximum Thermal Resistance	θ_{JC}	Junction to Case	TO-220-3/ TO-220-3(2)	1.67	$^{\circ}\text{C}/\text{W}$
			TO-220F-3	4.5	

Electrical Characteristics($T_C=25^{\circ}\text{C}$, unless otherwise specified.)

Parameter	Symbol	Conditions	Min	Typ	Max	Unit
Collector Cut-off Current ($V_{BE}=-1.5\text{V}$)	I_{CEV}	$V_{CE}=700\text{V}$			10	μA
Collector-Emitter Sustaining Voltage ($I_B=0$) (Note 2)	$V_{CEO}(\text{sus})$	$I_C=100\mu\text{A}$	450			V
Collector-Emitter Saturation Voltage	$V_{CE}(\text{sat})$	$I_C=1.0\text{A}, I_B=0.2\text{A}$			0.3	V
		$I_C=2.0\text{A}, I_B=0.5\text{A}$			0.6	
		$I_C=4.0\text{A}, I_B=1.0\text{A}$			0.9	
Base-Emitter Saturation Voltage	$V_{BE}(\text{sat})$	$I_C=1.0\text{A}, I_B=0.2\text{A}$			1.1	V
		$I_C=2.0\text{A}, I_B=0.5\text{A}$			1.3	
DC Current Gain (Note 2)	h_{FE}	$I_C=1.0\text{A}, V_{CE}=5.0\text{V}$	15		35	
		$I_C=2.0\text{A}, V_{CE}=5.0\text{V}$	8		35	
Turn -on Time with Resistive Load	t_{on}	$I_C=2\text{A}, V_{CC}=125\text{V}$ $I_{B1}=0.4\text{A}, I_{B2}=-0.4\text{V}$			0.8	μs
Storage Time with Resistive Load	t_s				4.5	μs
Fall Time with Resistive Load	t_f				0.9	μs
Output Capacitance	C_{OB}	$V_{CB}=10\text{V}, f=0.1\text{MHz}$		45		pF
Current Gain Bandwidth Product	f_T	$V_{CE}=10\text{V}, I_C=0.5\text{A}$	4			MHz

Note 2: Pulse test for Pulse Width $\leq 300\mu\text{s}$, Duty Cycle $\leq 2\%$.



Typical Performance Characteristics

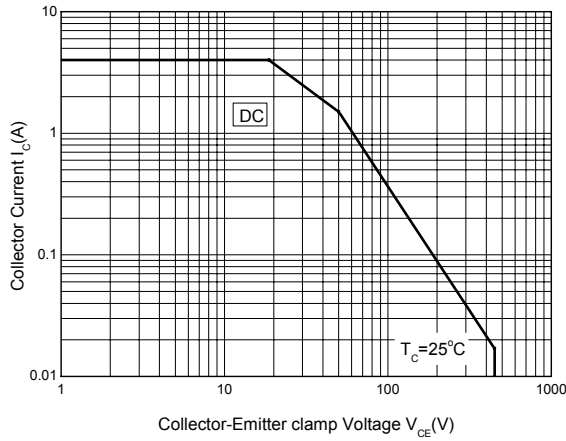

Figure 4. Safe Operating Areas (TO-220-3/TO-220-3(2) Package)

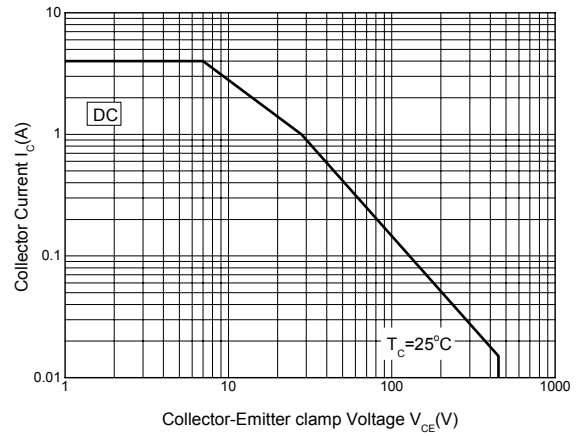

Figure 5. Safe Operating Areas (TO-220F-3 Package)

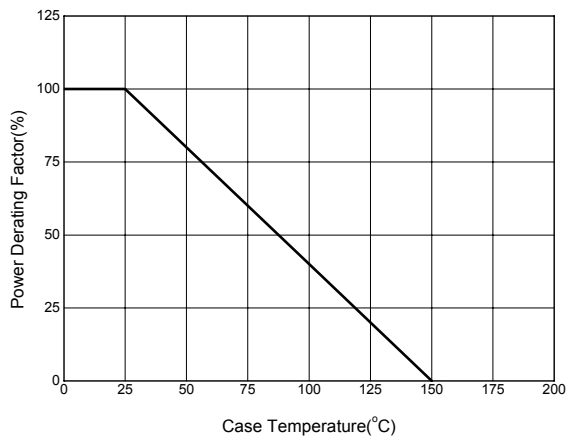

Figure 6. Power Derating Curve

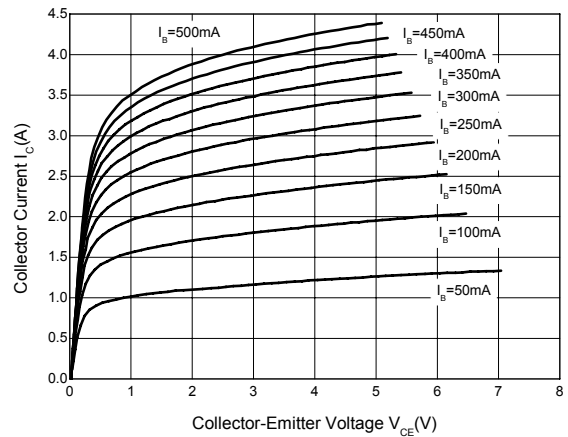

Figure 7. Static Characteristics



Typical Performance Characteristics (Continued)

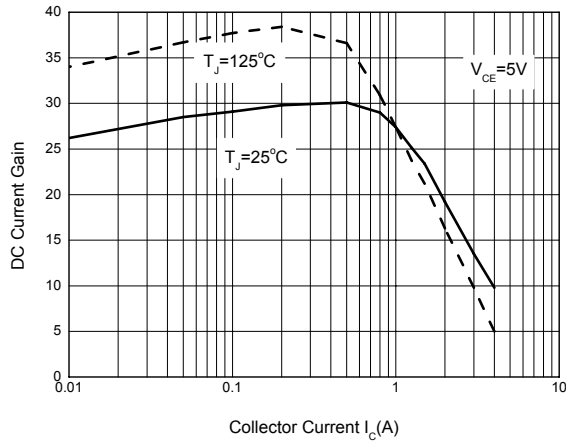

Figure 8. DC Current Gain

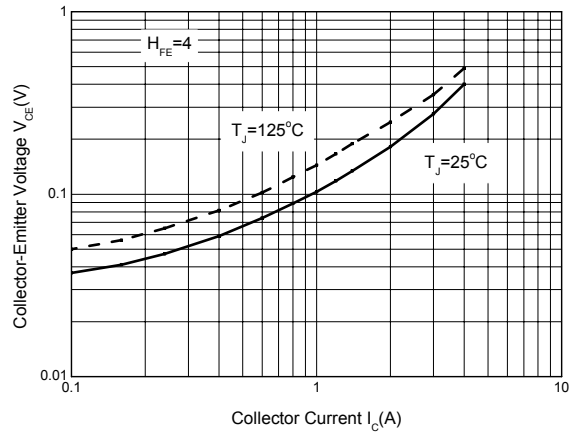

Figure 9. Collector-Emitter Saturation Region

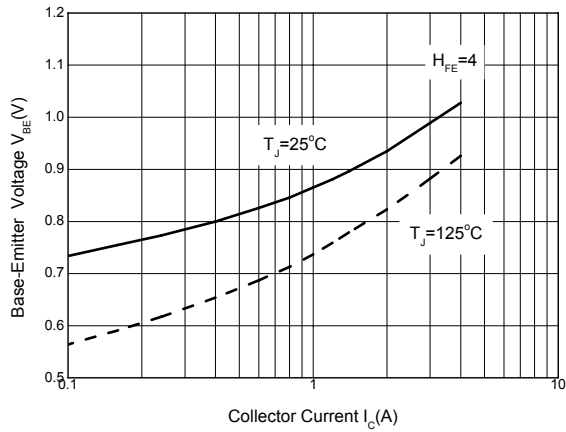

Figure 10. Base-Emitter Saturation Voltage



HIGH VOLTAGE FAST SWITCHING NPN POWER TRANSISTOR

APT13005

Mechanical Dimensions

TO-220-3

Unit: mm(inch)

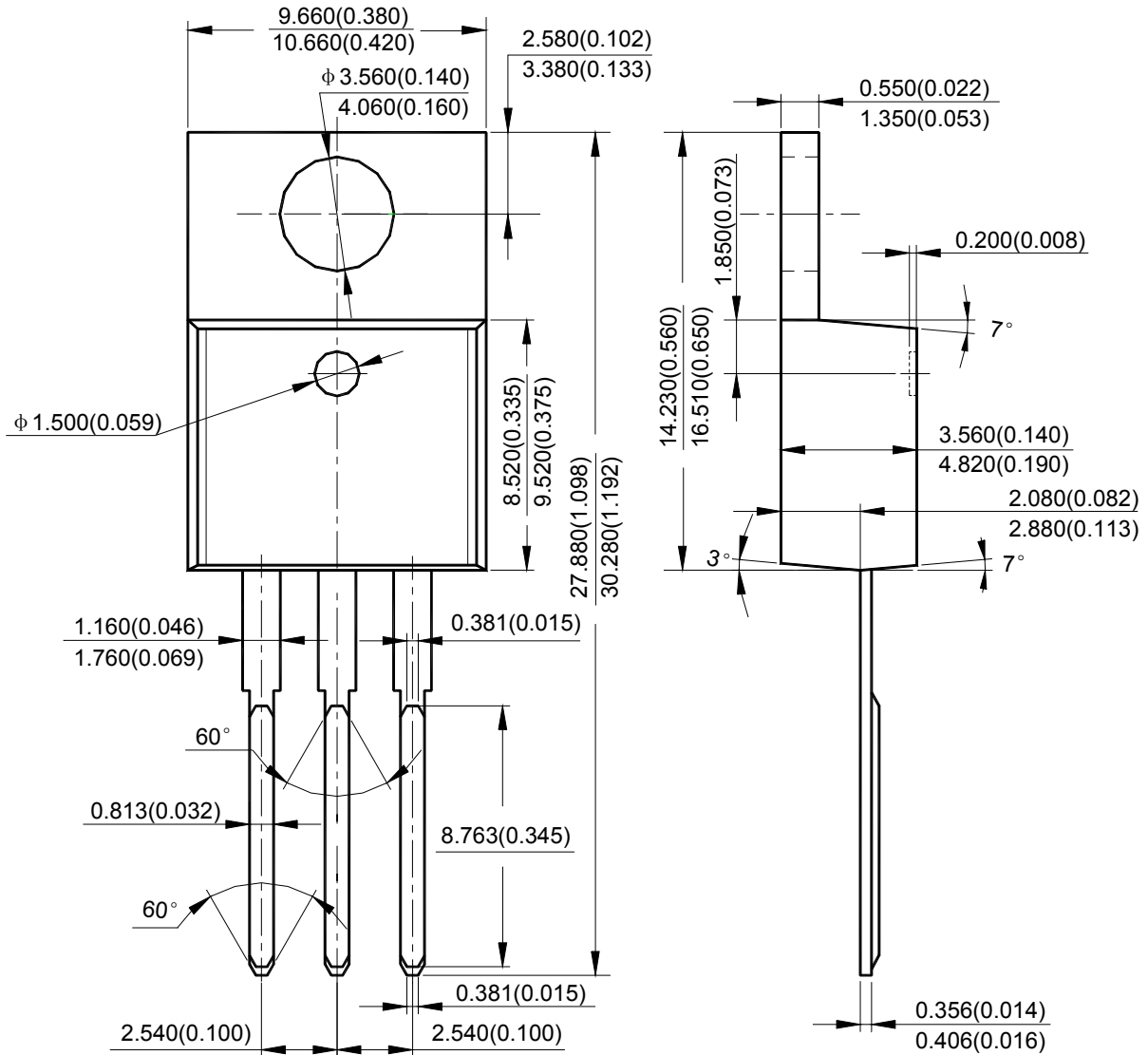



Mechanical Dimensions (Continued)

TO-220-3 (2)

Unit: mm(inch)

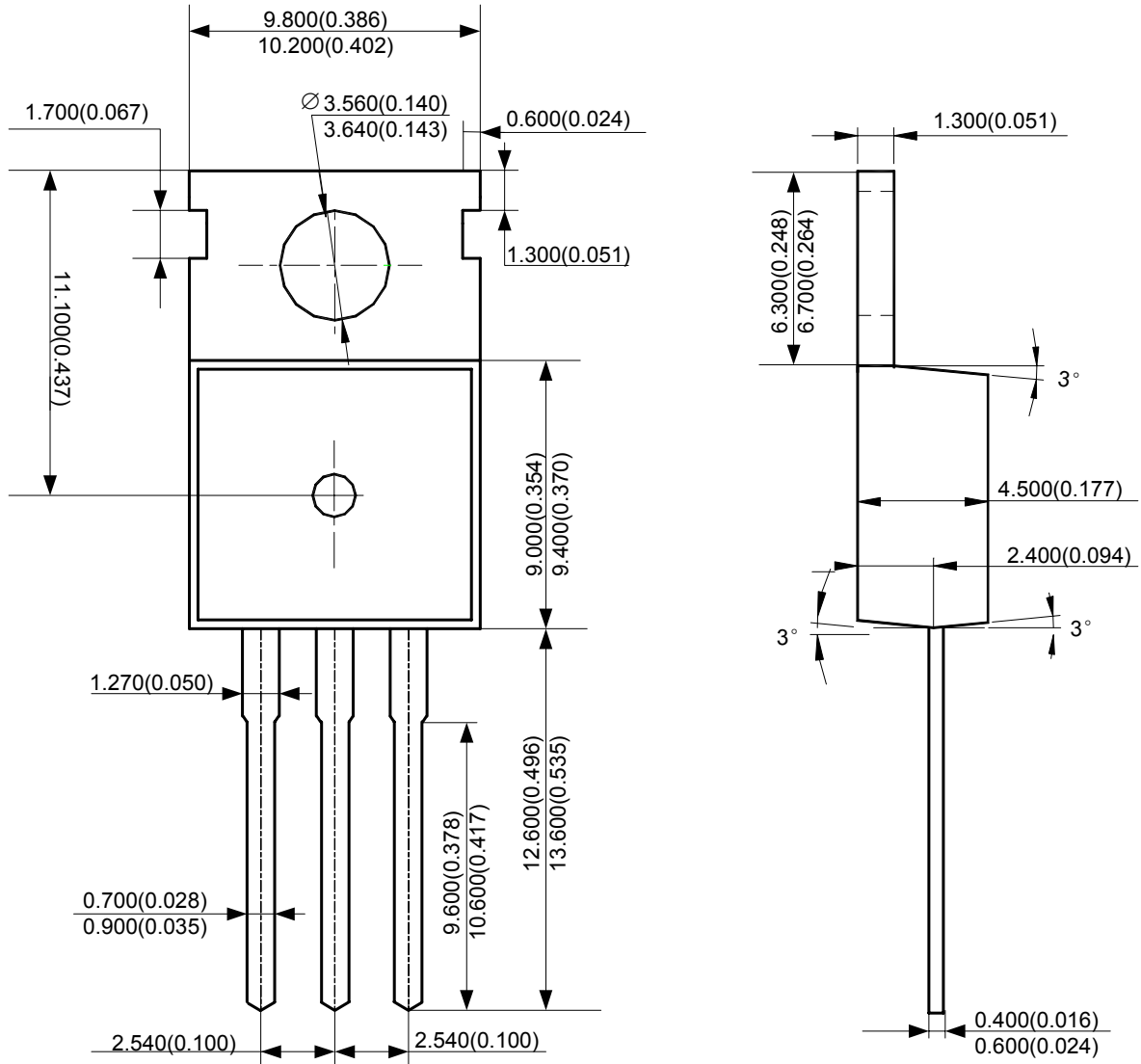



HIGH VOLTAGE FAST SWITCHING NPN POWER TRANSISTOR

APT13005

Mechanical Dimensions (Continued)

TO-220F-3

Unit: mm(inch)

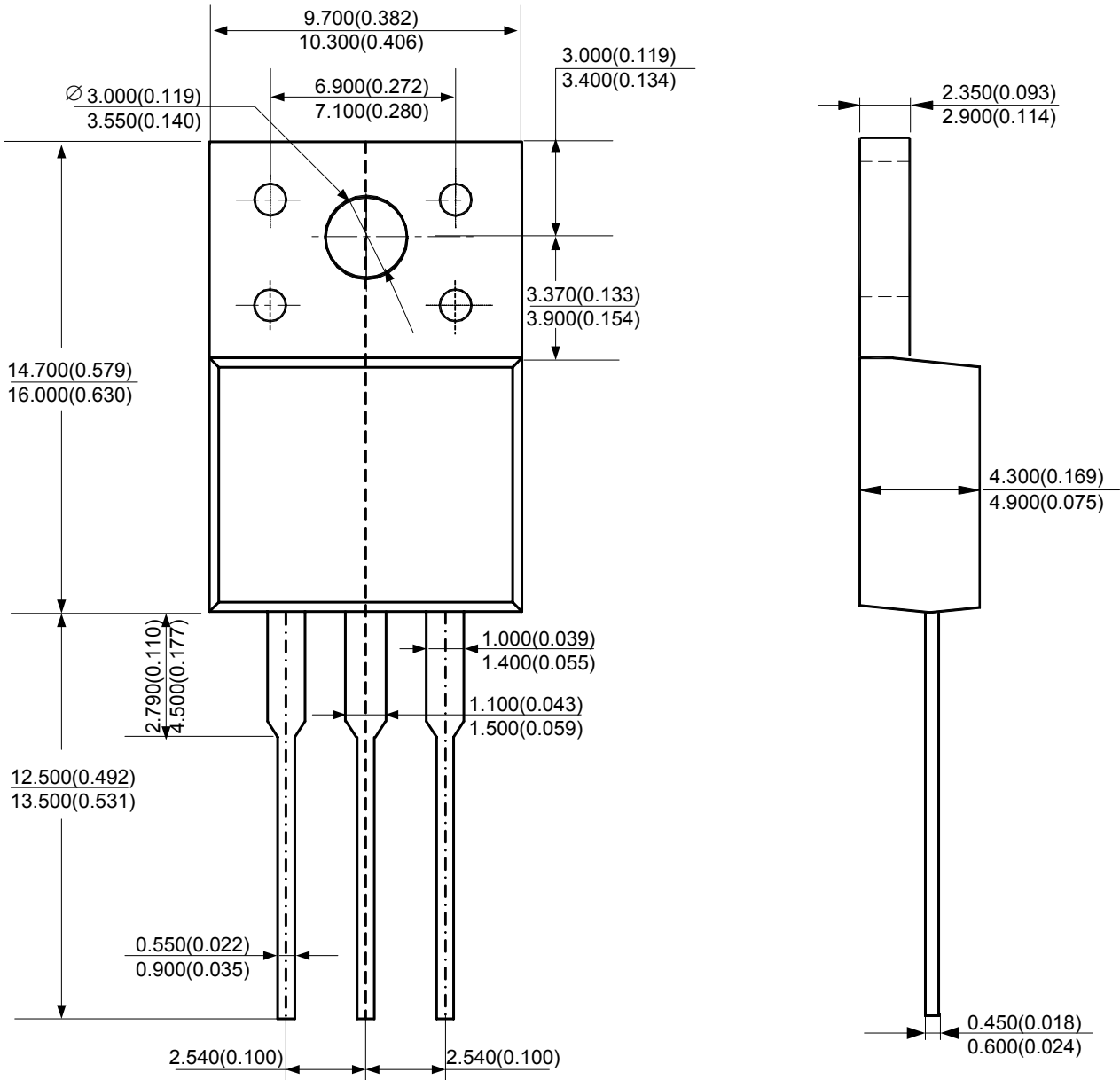



BCD Semiconductor Manufacturing Limited

<http://www.bcdsemi.com>

IMPORTANT NOTICE

BCD Semiconductor Manufacturing Limited reserves the right to make changes without further notice to any products or specifications herein. BCD Semiconductor Manufacturing Limited does not assume any responsibility for use of any its products for any particular purpose, nor does BCD Semiconductor Manufacturing Limited assume any liability arising out of the application or use of any its products or circuits. BCD Semiconductor Manufacturing Limited does not convey any license under its patent rights or other rights nor the rights of others.

MAIN SITE

- Headquarters

BCD Semiconductor Manufacturing Limited

No. 1600, Zi Xing Road, Shanghai Zizhu Science-based Industrial Park, 200241, China
Tel: +86-21-24162266, Fax: +86-21-24162277

- Wafer Fab

Shanghai SIM-BCD Semiconductor Manufacturing Co., Ltd.

800 Yi Shan Road, Shanghai 200233, China
Tel: +86-21-6485 1491, Fax: +86-21-5450 0008

REGIONAL SALES OFFICE

Shenzhen Office

Shanghai SIM-BCD Semiconductor Manufacturing Co., Ltd., Shenzhen Office

Unit A Room 1203, Skyworth Bldg., Gaoxin Ave. 1.S., Nanshan District, Shenzhen, China
Tel: +86-755-8826 7951
Fax: +86-755-8826 7865

Taiwan Office

BCD Semiconductor (Taiwan) Company Limited

4F, 298-1, Rui Guang Road, Nei-Hu District, Taipei, Taiwan
Tel: +886-2-2656 2808
Fax: +886-2-2656 2806

USA Office

BCD Semiconductor Corp.

30920 Huntwood Ave. Hayward, CA 94544, USA
Tel : +1-510-324-2988
Fax: +1-510-324-2788