

## AD8601/AD8602/AD8604

### FEATURES

- Low offset voltage: 500  $\mu$ V maximum
- Single-supply operation: 2.7 V to 5.5 V
- Low supply current: 750  $\mu$ A/Amplifier
- Wide bandwidth: 8 MHz
- Slew rate: 5 V/ $\mu$ s
- Low distortion
- No phase reversal
- Low input currents
- Unity-gain stable
- Qualified for automotive applications

### APPLICATIONS

- Current sensing
- Barcode scanners
- PA controls
- Battery-powered instrumentation
- Multipole filters
- Sensors
- ASIC input or output amplifiers
- Audio

### GENERAL DESCRIPTION

The AD8601, AD8602, and AD8604 are single, dual, and quad rail-to-rail, input and output, single-supply amplifiers featuring very low offset voltage and wide signal bandwidth. These amplifiers use a new, patented trimming technique that achieves superior performance without laser trimming. All are fully specified to operate on a 3 V to 5 V single supply.

The combination of low offsets, very low input bias currents, and high speed make these amplifiers useful in a wide variety of applications. Filters, integrators, diode amplifiers, shunt current sensors, and high impedance sensors all benefit from the combination of performance features. Audio and other ac applications benefit from the wide bandwidth and low distortion. For the most cost-sensitive applications, the D grades offer this ac performance with lower dc precision at a lower price point.

Applications for these amplifiers include audio amplification for portable devices, portable phone headsets, bar code scanners, portable instruments, cellular PA controls, and multipole filters.

The ability to swing rail-to-rail at both the input and output enables designers to buffer CMOS ADCs, DACs, ASICs, and other wide output swing devices in single-supply systems.

### PIN CONFIGURATIONS

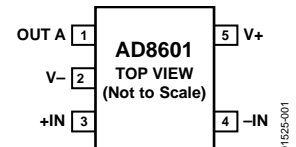

Figure 1. 5-Lead SOT-23 (RJ Suffix)



Figure 2. 8-Lead MSOP (RM Suffix) and 8-Lead SOIC (R-Suffix)

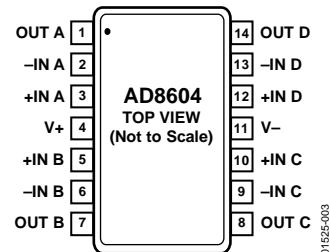

Figure 3. 14-Lead TSSOP (RU Suffix) and 14-Lead SOIC (R Suffix)

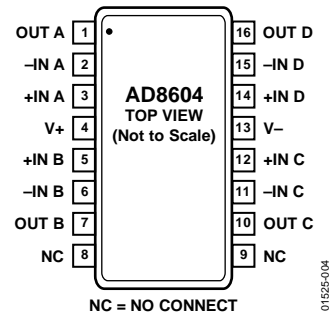

Figure 4. 16-Lead Shrink Small Outline QSOP (RQ Suffix)

The AD8601, AD8602, and AD8604 are specified over the extended industrial ( $-40^{\circ}\text{C}$  to  $+125^{\circ}\text{C}$ ) temperature range. The AD8601, single, is available in a tiny, 5-lead SOT-23 package. The AD8602, dual, is available in 8-lead MSOP and 8-lead, narrow SOIC surface-mount packages. The AD8604, quad, is available in 14-lead TSSOP, 14-lead SOIC, and 16-lead QSOP packages. See the Ordering Guide for automotive grades.

### Rev. G

Information furnished by Analog Devices is believed to be accurate and reliable. However, no responsibility is assumed by Analog Devices for its use, nor for any infringements of patents or other rights of third parties that may result from its use. Specifications subject to change without notice. No license is granted by implication or otherwise under any patent or patent rights of Analog Devices. Trademarks and registered trademarks are the property of their respective owners.

## TABLE OF CONTENTS

Features .....	1	Input Overvoltage Protection .....	16
Applications .....	1	Overdrive Recovery .....	16
General Description .....	1	Power-On Time .....	16
Pin Configurations .....	1	Using the AD8602 in High Source Impedance Applications .....	16
Revision History .....	2	High Side and Low Side, Precision Current Monitoring .....	16
Specifications .....	3	Using the AD8601 in Single-Supply, Mixed Signal Applications .....	17
Electrical Characteristics .....	3	PC100 Compliance for Computer Audio Applications .....	17
Absolute Maximum Ratings .....	5	SPICE Model .....	18
Thermal Resistance .....	5	Outline Dimensions .....	19
ESD Caution .....	5	Ordering Guide .....	22
Typical Performance Characteristics .....	6	Automotive Products .....	22
Theory of Operation .....	15		
Rail-to-Rail Input Stage .....	15		

## REVISION HISTORY

### 1/11—Rev. F to Rev. G

Changes to Ordering Guide .....	22
Change to Automotive Products Section .....	22

### 5/10—Rev. E to Rev. F

Changes to Features Section and General Description Section .....	1
Changes to Ordering Guide .....	22
Added Automotive Products Section .....	22

### 2/10—Rev. D to Rev. E

Add 16-Lead QSOP .....	Universal
Changes to Table 3 and Table 4 .....	5
Updated Outline Dimensions .....	19
Changes to Ordering Guide .....	22

### 11/03—Rev. C to Rev. D

Changes to Features .....	1
Changes to Ordering Guide .....	4

### 3/03—Rev. B to Rev. C

Changes to Features .....	1
---------------------------	---

### 3/03—Rev. A to Rev. B

Change to Features .....	1
Change to Functional Block Diagrams .....	1
Change to TPC 39 .....	11
Changes to Figures 4 and 5 .....	14
Changes to Equations 2 and 3 .....	14, 15
Updated Outline Dimensions .....	16

# SPECIFICATIONS

## ELECTRICAL CHARACTERISTICS

$V_S = 3\text{ V}$ ,  $V_{CM} = V_S/2$ ,  $T_A = 25^\circ\text{C}$ , unless otherwise noted.

Table 1.

Parameter	Symbol	Conditions	A Grade			D Grade			Unit
			Min	Typ	Max	Min	Typ	Max	
INPUT CHARACTERISTICS									
Offset Voltage (AD8601/AD8602)	$V_{OS}$	$0\text{ V} \leq V_{CM} \leq 1.3\text{ V}$ $-40^\circ\text{C} \leq T_A \leq +85^\circ\text{C}$		80	500		1100	6000	$\mu\text{V}$
								7000	$\mu\text{V}$
		$-40^\circ\text{C} \leq T_A \leq +125^\circ\text{C}$ $0\text{ V} \leq V_{CM} \leq 3\text{ V}^1$						7000	$\mu\text{V}$
				350	750		1300	6000	$\mu\text{V}$
		$-40^\circ\text{C} \leq T_A \leq +85^\circ\text{C}$ $-40^\circ\text{C} \leq T_A \leq +125^\circ\text{C}$						7000	$\mu\text{V}$
								7000	$\mu\text{V}$
Offset Voltage (AD8604)	$V_{OS}$	$V_{CM} = 0\text{ V to } 1.3\text{ V}$ $-40^\circ\text{C} \leq T_A \leq +85^\circ\text{C}$		80	600		1100	6000	$\mu\text{V}$
								7000	$\mu\text{V}$
		$-40^\circ\text{C} \leq T_A \leq +125^\circ\text{C}$ $V_{CM} = 0\text{ V to } 3.0\text{ V}^1$						7000	$\mu\text{V}$
				350	800		1300	6000	$\mu\text{V}$
		$-40^\circ\text{C} \leq T_A \leq +85^\circ\text{C}$ $-40^\circ\text{C} \leq T_A \leq +125^\circ\text{C}$						7000	$\mu\text{V}$
								7000	$\mu\text{V}$
Input Bias Current	$I_B$	$-40^\circ\text{C} \leq T_A \leq +85^\circ\text{C}$ $-40^\circ\text{C} \leq T_A \leq +125^\circ\text{C}$		0.2	60		0.2	200	$\text{pA}$
								200	$\text{pA}$
Input Offset Current	$I_{OS}$	$-40^\circ\text{C} \leq T_A \leq +85^\circ\text{C}$ $-40^\circ\text{C} \leq T_A \leq +125^\circ\text{C}$		150	1000		150	1000	$\text{pA}$
								100	$\text{pA}$
Input Voltage Range	Common-Mode Rejection Ratio	$V_{CM} = 0\text{ V to } 3\text{ V}$			3			3	$\text{V}$
				68	83		52	65	$\text{dB}$
Large Signal Voltage Gain	$A_{VO}$	$V_O = 0.5\text{ V to } 2.5\text{ V}$ , $R_L = 2\text{ k}\Omega$ , $V_{CM} = 0\text{ V}$		30	100		20	60	$\text{V/mV}$
Offset Voltage Drift	$\Delta V_{OS}/\Delta T$			2			2	$\mu\text{V}/^\circ\text{C}$	
OUTPUT CHARACTERISTICS									
Output Voltage High	$V_{OH}$	$I_L = 1.0\text{ mA}$ $-40^\circ\text{C} \leq T_A \leq +125^\circ\text{C}$		2.92	2.95		2.92	2.95	$\text{V}$
								2.88	$\text{V}$
Output Voltage Low	$V_{OL}$	$I_L = 1.0\text{ mA}$ $-40^\circ\text{C} \leq T_A \leq +125^\circ\text{C}$			20	35		20	35
						50			50
Output Current	$I_{OUT}$			$\pm 30$			$\pm 30$	$\text{mA}$	
Closed-Loop Output Impedance	$Z_{OUT}$	$f = 1\text{ MHz}$ , $A_V = 1$		12			12	$\Omega$	
POWER SUPPLY									
Power Supply Rejection Ratio	PSRR	$V_S = 2.7\text{ V to } 5.5\text{ V}$	67	80		56	72	$\text{dB}$	
Supply Current/Amplifier	$I_{SY}$	$V_O = 0\text{ V}$ $-40^\circ\text{C} \leq T_A \leq +125^\circ\text{C}$			680	1000		680	1000
						1300			1300
DYNAMIC PERFORMANCE									
Slew Rate	SR	$R_L = 2\text{ k}\Omega$		5.2			5.2	$\text{V}/\mu\text{s}$	
Settling Time	$t_s$	To 0.01%		<0.5			<0.5	$\mu\text{s}$	
Gain Bandwidth Product	GBP			8.2			8.2	$\text{MHz}$	
Phase Margin	$\Phi_o$			50			50	Degrees	
NOISE PERFORMANCE									
Voltage Noise Density	$e_n$	$f = 1\text{ kHz}$ $f = 10\text{ kHz}$		33			33	$\text{nV}/\sqrt{\text{Hz}}$	
					18			18	
Current Noise Density	$i_n$			0.05			0.05	$\text{pA}/\sqrt{\text{Hz}}$	

<sup>1</sup> For  $V_{CM}$  between 1.3 V and 1.8 V,  $V_{OS}$  may exceed specified value.

# AD8601/AD8602/AD8604

$V_S = 5.0\text{ V}$ ,  $V_{CM} = V_S/2$ ,  $T_A = 25^\circ\text{C}$ , unless otherwise noted.

Table 2.

Parameter	Symbol	Conditions	A Grade			D Grade			Unit
			Min	Typ	Max	Min	Typ	Max	
INPUT CHARACTERISTICS									
Offset Voltage (AD8601/AD8602)	$V_{OS}$	$0\text{ V} \leq V_{CM} \leq 5\text{ V}$ $-40^\circ\text{C} \leq T_A \leq +125^\circ\text{C}$		80	500		1300	6000	$\mu\text{V}$
Offset Voltage (AD8604)	$V_{OS}$	$V_{CM} = 0\text{ V to } 5\text{ V}$ $-40^\circ\text{C} \leq T_A \leq +125^\circ\text{C}$		80	600		1300	6000	$\mu\text{V}$
Input Bias Current	$I_B$	$-40^\circ\text{C} \leq T_A \leq +85^\circ\text{C}$ $-40^\circ\text{C} \leq T_A \leq +125^\circ\text{C}$		0.2	60		0.2	200	$\text{pA}$
					100		200	$\text{pA}$	
					1000		1000	$\text{pA}$	
Input Offset Current	$I_{OS}$	$-40^\circ\text{C} \leq T_A \leq +85^\circ\text{C}$ $-40^\circ\text{C} \leq T_A \leq +125^\circ\text{C}$		0.1	30		0.1	100	$\text{pA}$
					6		6	100	$\text{pA}$
					25		25	500	$\text{pA}$
Input Voltage Range			0		5	0		5	$\text{V}$
Common-Mode Rejection Ratio	CMRR	$V_{CM} = 0\text{ V to } 5\text{ V}$	74	89		56	67		$\text{dB}$
Large Signal Voltage Gain	$A_{VO}$	$V_O = 0.5\text{ V to } 4.5\text{ V}$ , $R_L = 2\text{ k}\Omega$ , $V_{CM} = 0\text{ V}$	30	80		20	60		$\text{V/mV}$
Offset Voltage Drift	$\Delta V_{OS}/\Delta T$			2			2		$\mu\text{V}/^\circ\text{C}$
OUTPUT CHARACTERISTICS									
Output Voltage High	$V_{OH}$	$I_L = 1.0\text{ mA}$ $I_L = 10\text{ mA}$ $-40^\circ\text{C} \leq T_A \leq +125^\circ\text{C}$	4.925	4.975		4.925	4.975		$\text{V}$
			4.7	4.77		4.7	4.77	$\text{V}$	
			4.6			4.6		$\text{V}$	
Output Voltage Low	$V_{OL}$	$I_L = 1.0\text{ mA}$ $I_L = 10\text{ mA}$ $-40^\circ\text{C} \leq T_A \leq +125^\circ\text{C}$		15	30		15	30	$\text{mV}$
				125	175		125	175	$\text{mV}$
					250			250	$\text{mV}$
Output Current	$I_{OUT}$			$\pm 50$		$\pm 50$		$\text{mA}$	
Closed-Loop Output Impedance	$Z_{OUT}$	$f = 1\text{ MHz}$ , $A_V = 1$		10			10		$\Omega$
POWER SUPPLY									
Power Supply Rejection Ratio	PSRR	$V_S = 2.7\text{ V to } 5.5\text{ V}$	67	80		56	72		$\text{dB}$
Supply Current/Amplifier	$I_{SY}$	$V_O = 0\text{ V}$ $-40^\circ\text{C} \leq T_A \leq +125^\circ\text{C}$		750	1200		750	1200	$\mu\text{A}$
					1500			1500	$\mu\text{A}$
DYNAMIC PERFORMANCE									
Slew Rate	SR	$R_L = 2\text{ k}\Omega$		6			6		$\text{V}/\mu\text{s}$
Settling Time	$t_S$	To 0.01%		<1.0			<1.0		$\mu\text{s}$
Full Power Bandwidth	BWp	<1% distortion		360			360		$\text{kHz}$
Gain Bandwidth Product	GBP			8.4			8.4		$\text{MHz}$
Phase Margin	$\Phi_O$			55			55		Degrees
NOISE PERFORMANCE									
Voltage Noise Density	$e_n$	$f = 1\text{ kHz}$ $f = 10\text{ kHz}$		33			33		$\text{nV}/\sqrt{\text{Hz}}$
				18			18	$\text{nV}/\sqrt{\text{Hz}}$	
Current Noise Density	$i_n$	$f = 1\text{ kHz}$		0.05			0.05		$\text{pA}/\sqrt{\text{Hz}}$

## ABSOLUTE MAXIMUM RATINGS

Table 3.

Parameter	Rating
Supply Voltage	6 V
Input Voltage	GND to $V_S$
Differential Input Voltage	$\pm 6$ V
Storage Temperature Range	$-65^{\circ}\text{C}$ to $+150^{\circ}\text{C}$
Operating Temperature Range	$-40^{\circ}\text{C}$ to $+125^{\circ}\text{C}$
Junction Temperature Range	$-65^{\circ}\text{C}$ to $+150^{\circ}\text{C}$
Lead Temperature Range (Soldering, 60 sec)	$300^{\circ}\text{C}$
ESD	2 kV HBM

Stresses above those listed under Absolute Maximum Ratings may cause permanent damage to the device. This is a stress rating only; functional operation of the device at these or any other conditions above those indicated in the operational section of this specification is not implied. Exposure to absolute maximum rating conditions for extended periods may affect device reliability.

## THERMAL RESISTANCE

$\theta_{JA}$  is specified for worst-case conditions, that is, a device soldered onto a circuit board for surface-mount packages using a standard 4-layer board.

Table 4. Thermal Resistance

Package Type	$\theta_{JA}$	$\theta_{JC}$	Unit
5-Lead SOT-23 (RJ)	190	92	$^{\circ}\text{C}/\text{W}$
8-Lead SOIC (R)	120	45	$^{\circ}\text{C}/\text{W}$
8-Lead MSOP (RM)	142	45	$^{\circ}\text{C}/\text{W}$
14-Lead SOIC (R)	115	36	$^{\circ}\text{C}/\text{W}$
14-Lead TSSOP (RU)	112	35	$^{\circ}\text{C}/\text{W}$
16-Lead QSOP (RQ)	115	36	$^{\circ}\text{C}/\text{W}$

## ESD CAUTION



**ESD (electrostatic discharge) sensitive device.** Charged devices and circuit boards can discharge without detection. Although this product features patented or proprietary protection circuitry, damage may occur on devices subjected to high energy ESD. Therefore, proper ESD precautions should be taken to avoid performance degradation or loss of functionality.

## TYPICAL PERFORMANCE CHARACTERISTICS

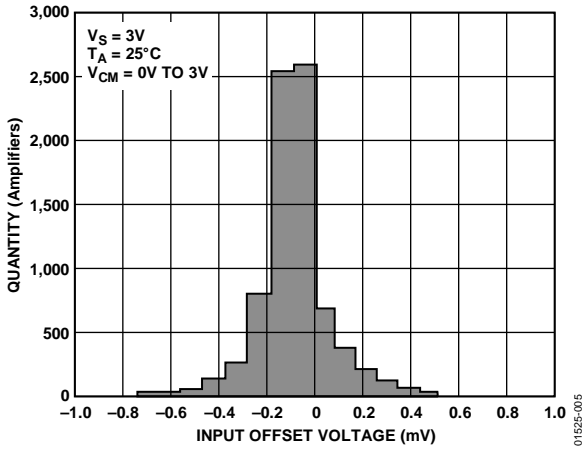

Figure 5. Input Offset Voltage Distribution

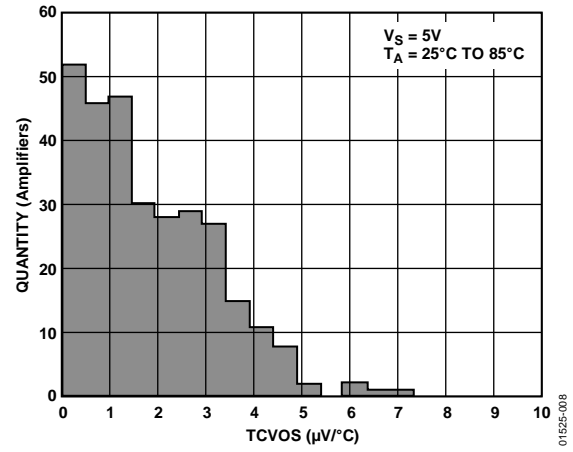

Figure 8. Input Offset Voltage Drift Distribution

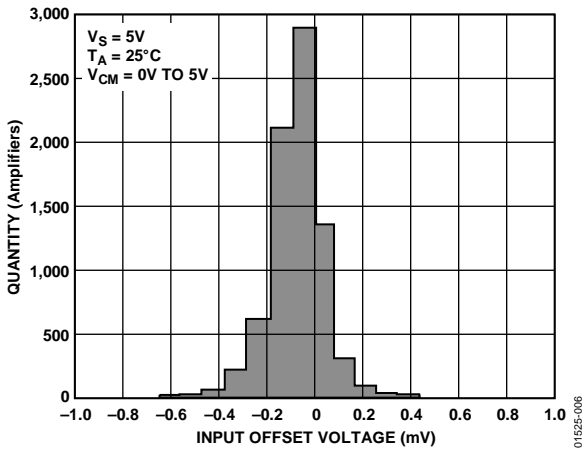

Figure 6. Input Offset Voltage Distribution

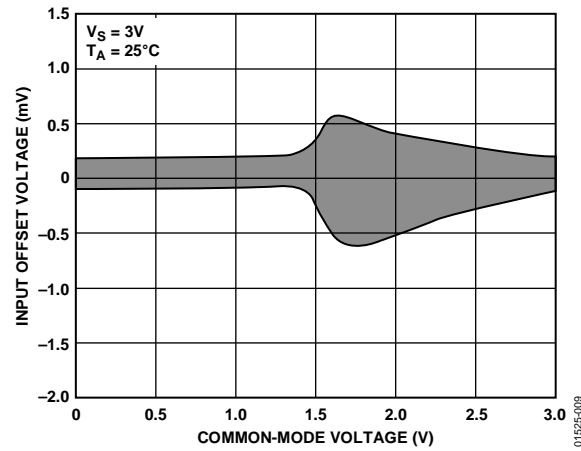

Figure 9. Input Offset Voltage vs. Common-Mode Voltage

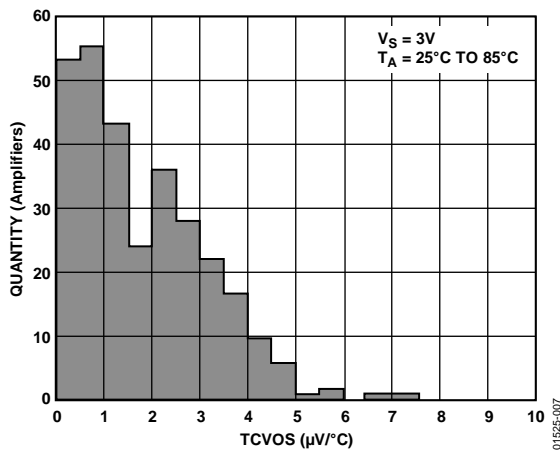

Figure 7. Input Offset Voltage Drift Distribution

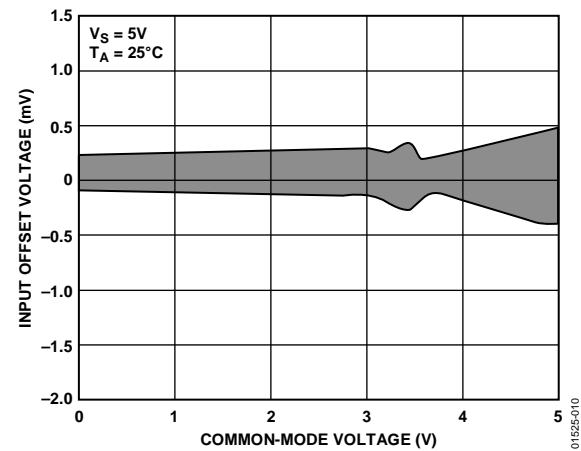

Figure 10. Input Offset Voltage vs. Common-Mode Voltage

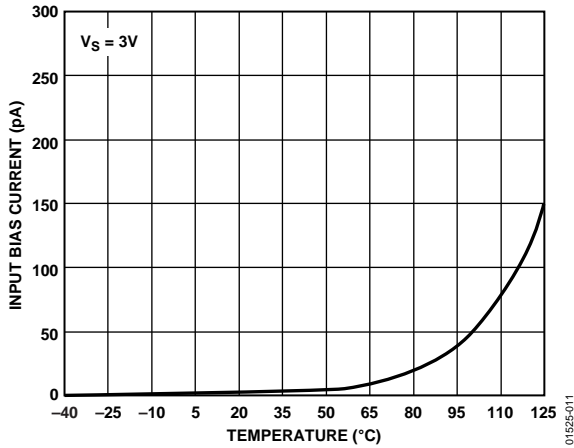

Figure 11. Input Bias Current vs. Temperature

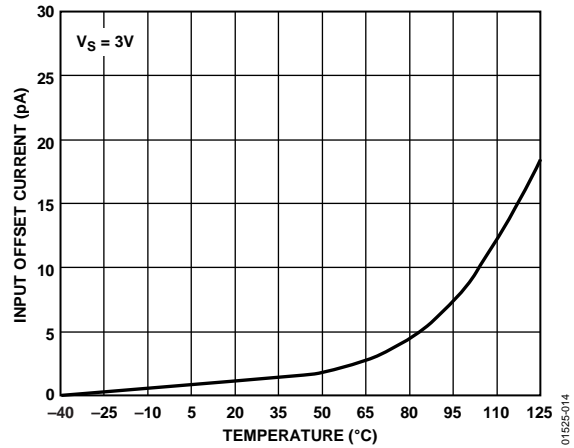

Figure 14. Input Offset Current vs. Temperature

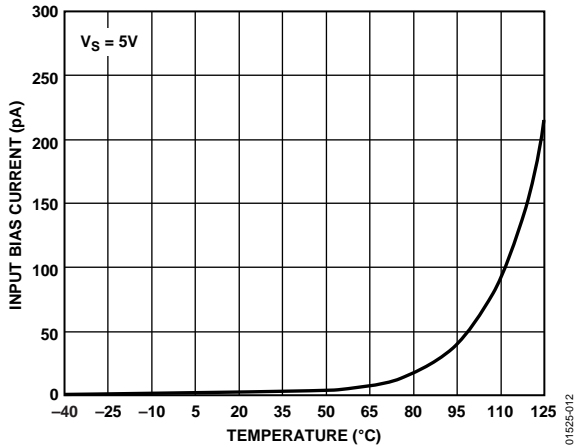

Figure 12. Input Bias Current vs. Temperature

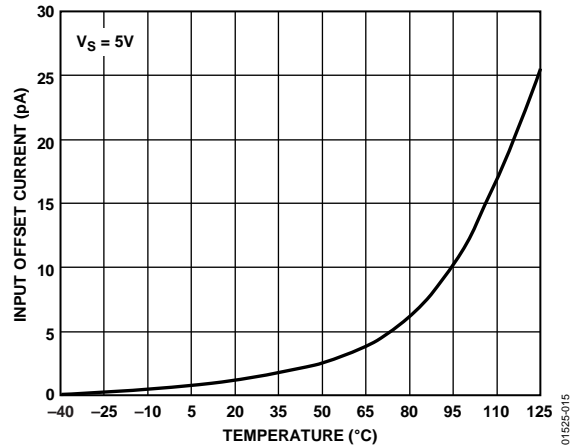

Figure 15. Input Offset Current vs. Temperature

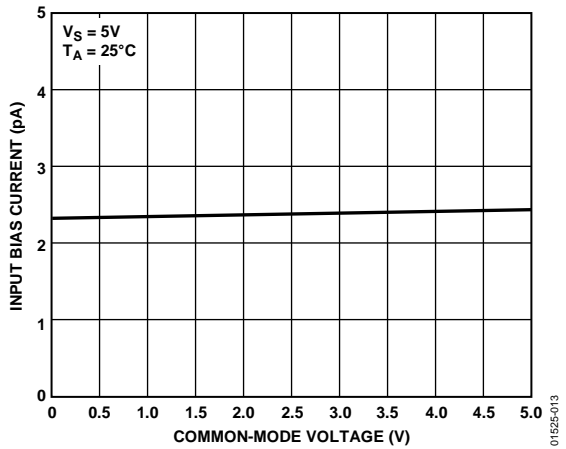

Figure 13. Input Bias Current vs. Common-Mode Voltage

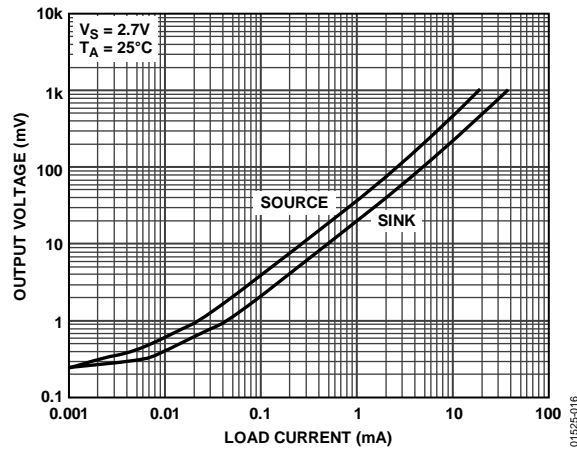

Figure 16. Output Voltage to Supply Rail vs. Load Current

# AD8601/AD8602/AD8604

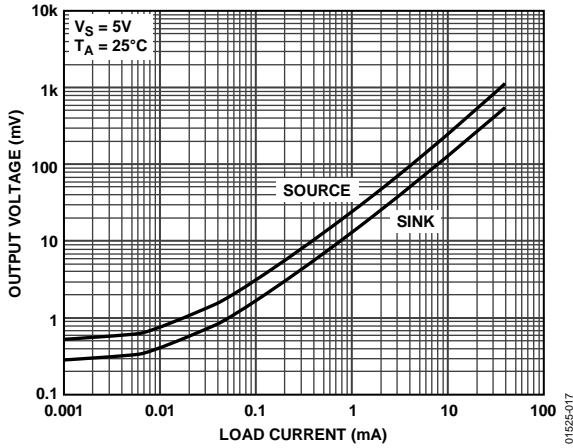

Figure 17. Output Voltage to Supply Rail vs. Load Current

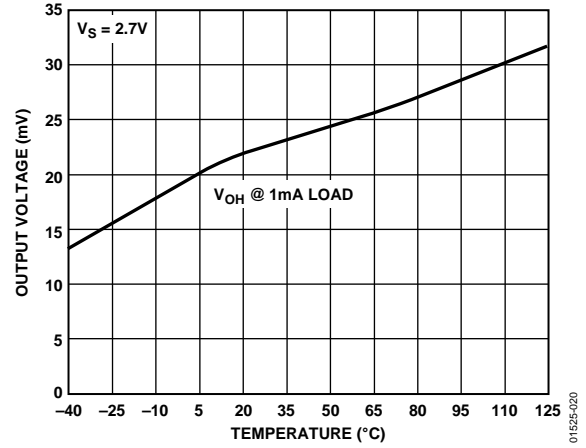

Figure 20. Output Voltage Swing vs. Temperature

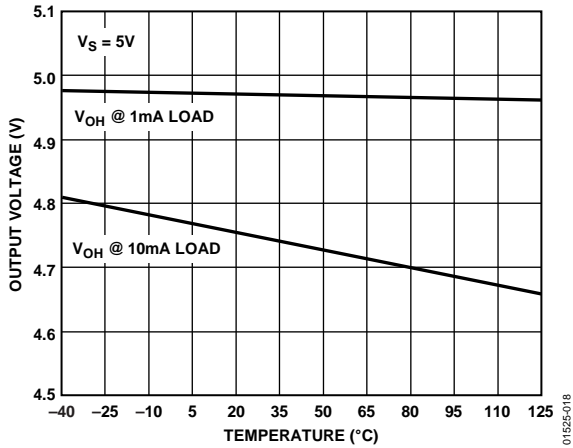

Figure 18. Output Voltage Swing vs. Temperature

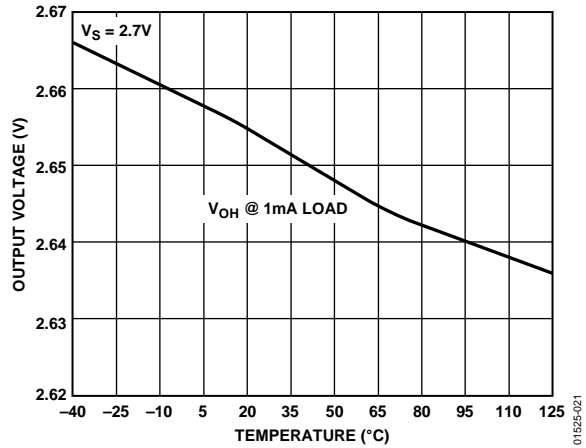

Figure 21. Output Voltage Swing vs. Temperature

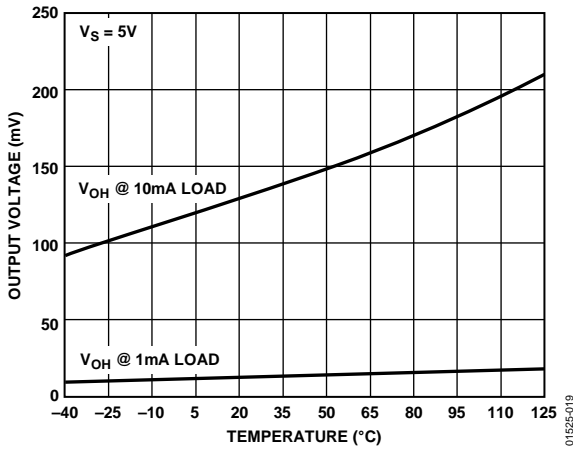

Figure 19. Output Voltage Swing vs. Temperature

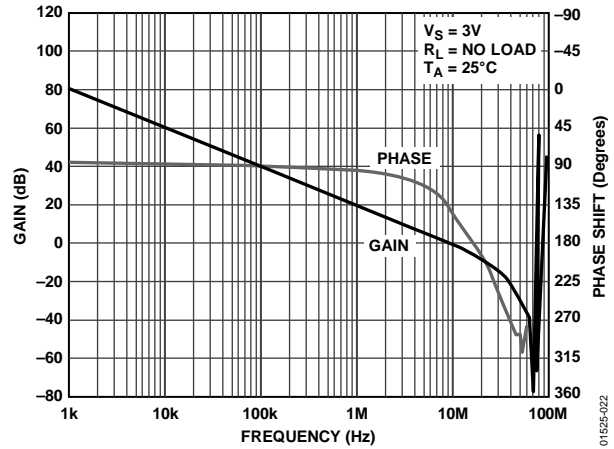

Figure 22. Open-Loop Gain and Phase vs. Frequency



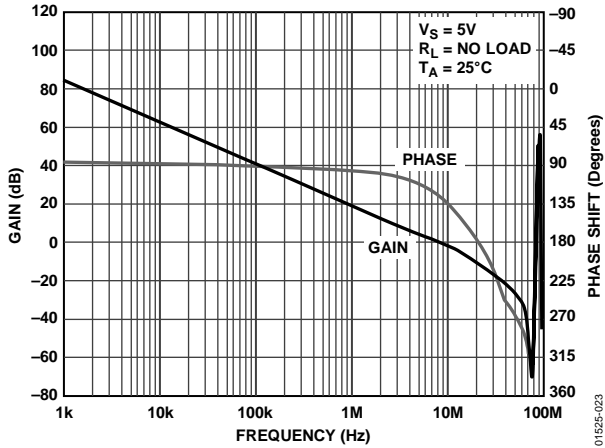

Figure 23. Open-Loop Gain and Phase vs. Frequency

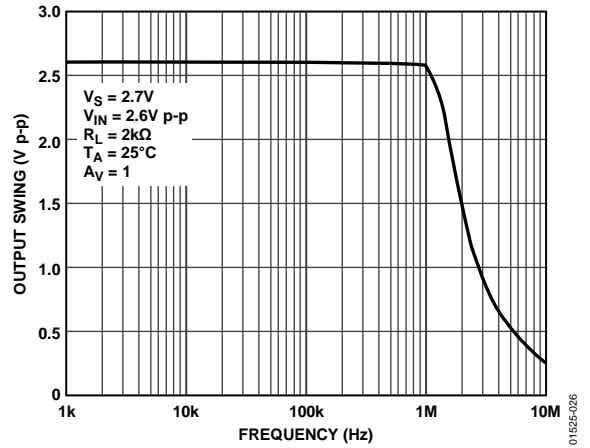

Figure 26. Closed-Loop Output Voltage Swing vs. Frequency

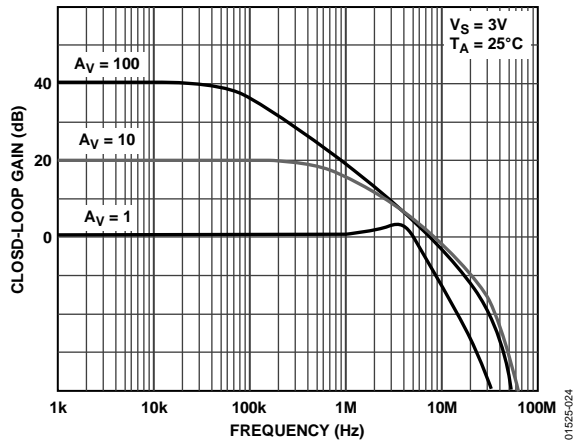

Figure 24. Closed-Loop Gain vs. Frequency

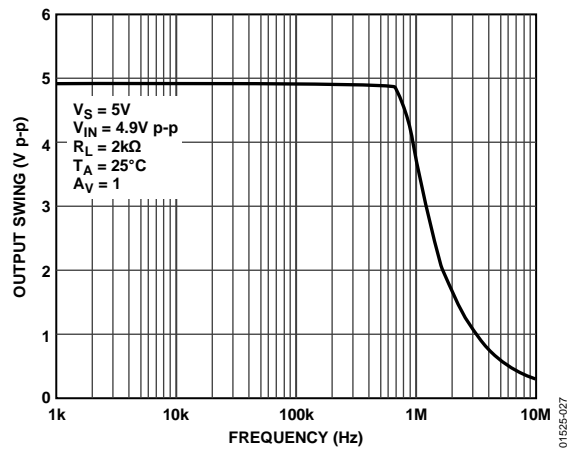

Figure 27. Closed-Loop Output Voltage Swing vs. Frequency

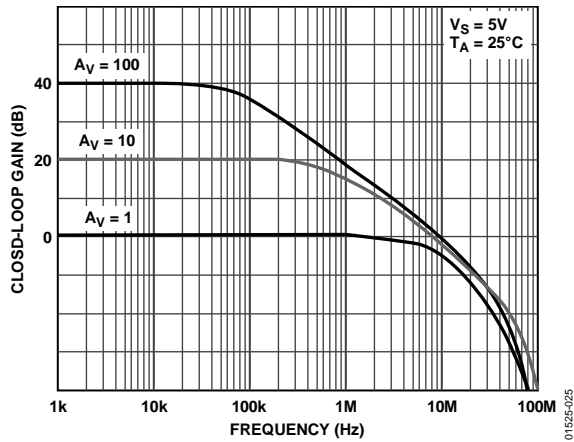

Figure 25. Closed-Loop Gain vs. Frequency

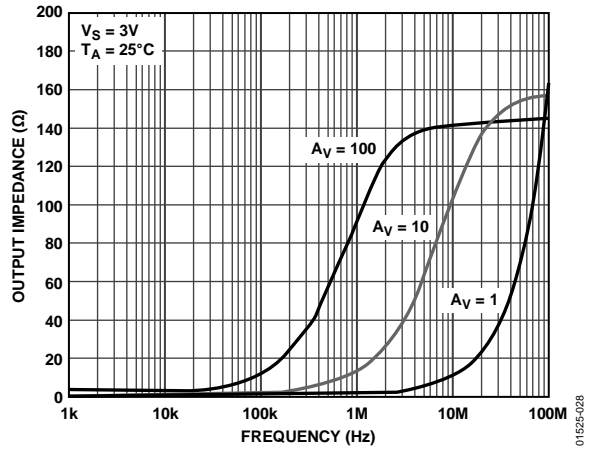

Figure 28. Output Impedance vs. Frequency

# AD8601/AD8602/AD8604

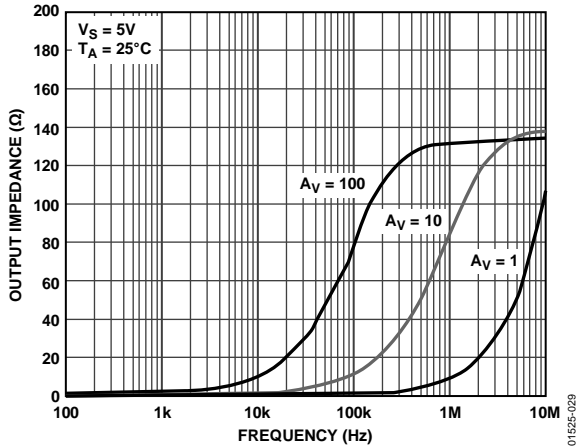

Figure 29. Output Impedance vs. Frequency

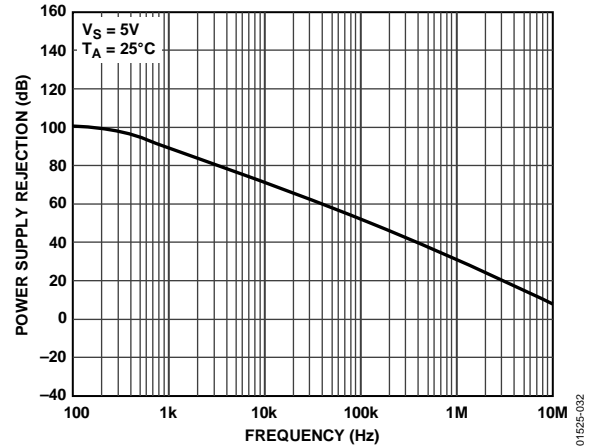

Figure 32. Power Supply Rejection Ratio vs. Frequency

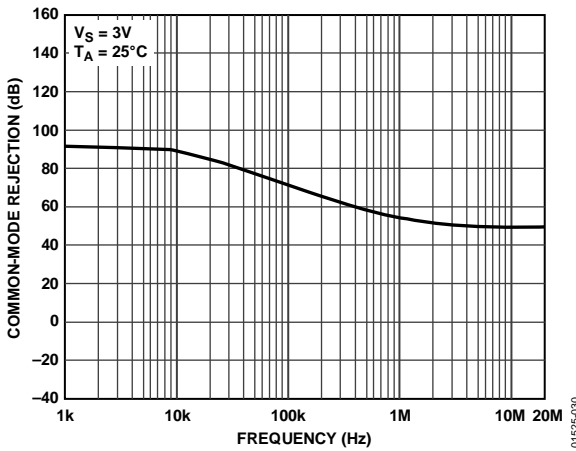

Figure 30. Common-Mode Rejection Ratio vs. Frequency

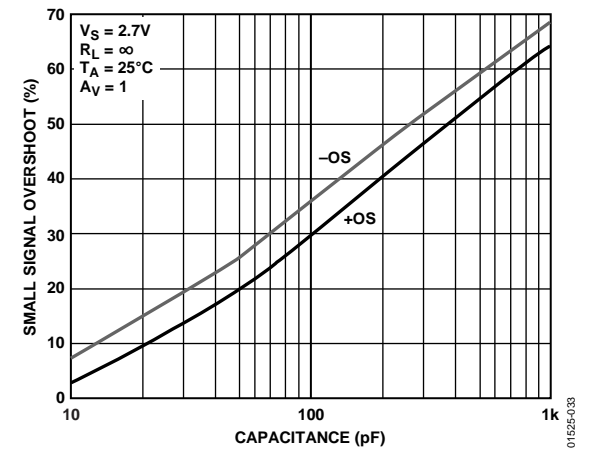

Figure 33. Small Signal Overshoot vs. Load Capacitance

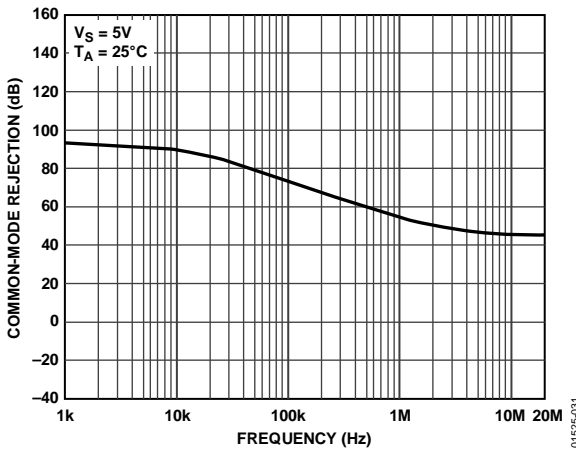

Figure 31. Common-Mode Rejection Ratio vs. Frequency

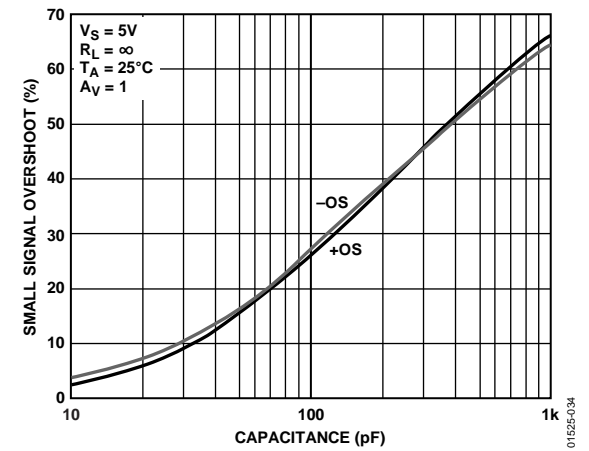

Figure 34. Small Signal Overshoot vs. Load Capacitance

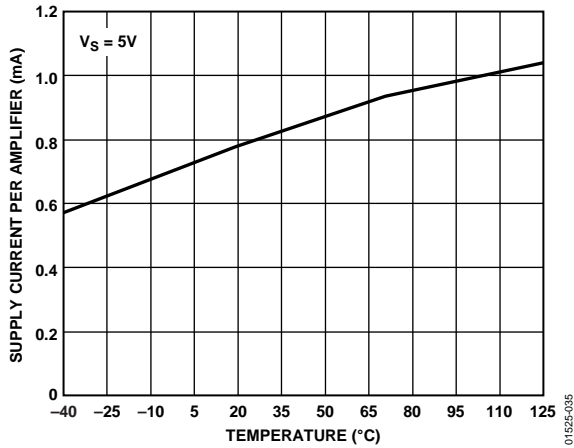

Figure 35. Supply Current per Amplifier vs. Temperature

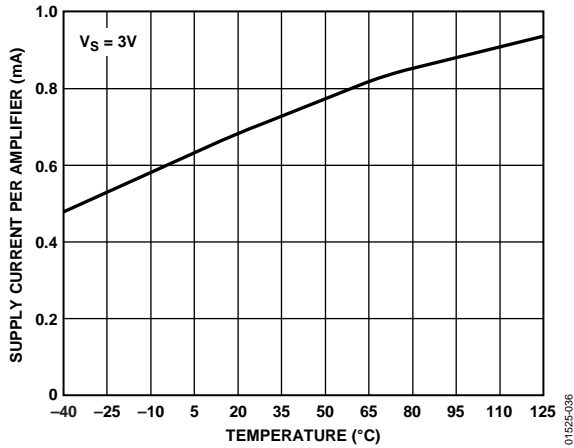

Figure 36. Supply Current per Amplifier vs. Temperature

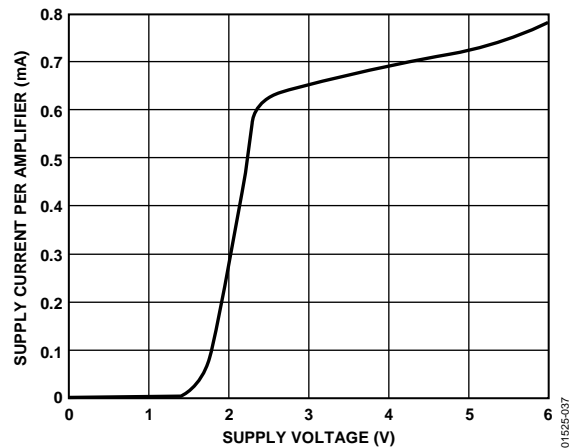

Figure 37. Supply Current per Amplifier vs. Supply Voltage

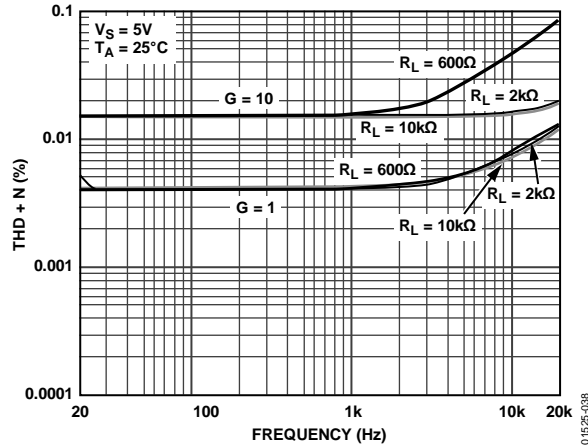

Figure 38. Total Harmonic Distortion + Noise vs. Frequency

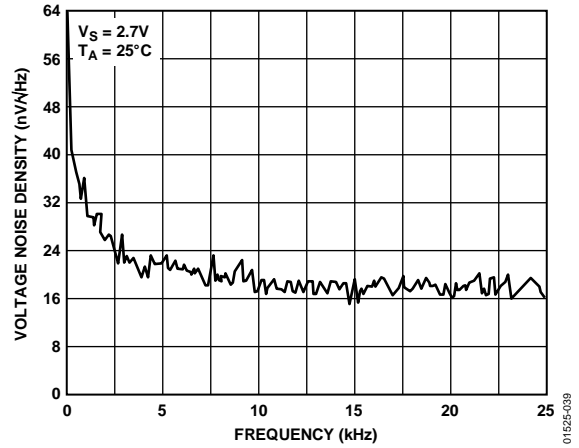

Figure 39. Voltage Noise Density vs. Frequency

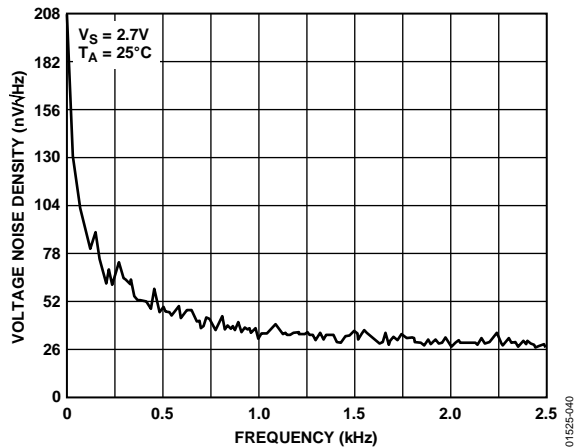

Figure 40. Voltage Noise Density vs. Frequency

# AD8601/AD8602/AD8604

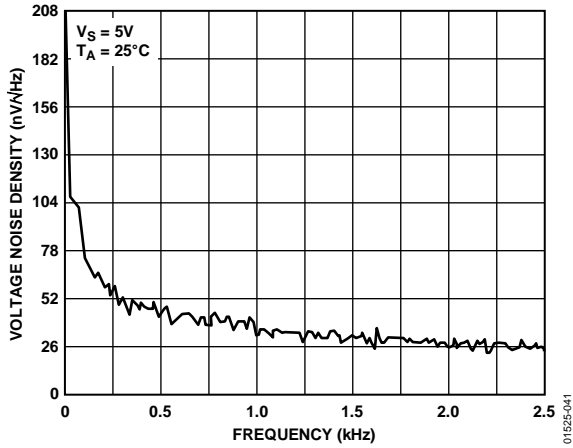

Figure 41. Voltage Noise Density vs. Frequency

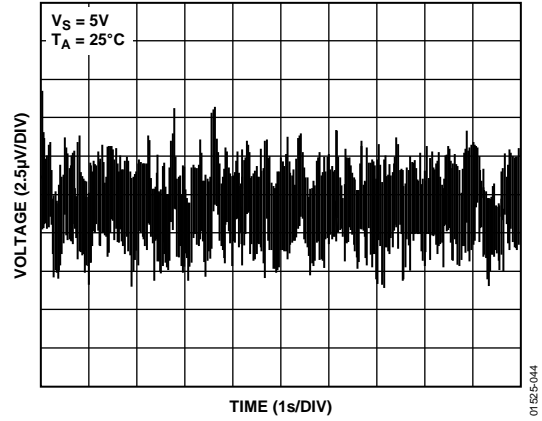

Figure 44. 0.1 Hz to 10 Hz Input Voltage Noise

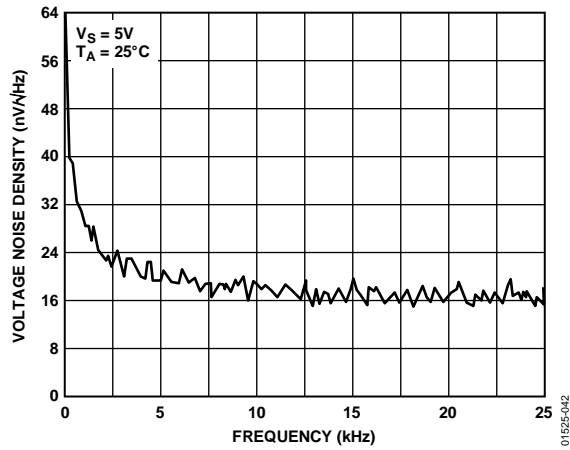

Figure 42. Voltage Noise Density vs. Frequency

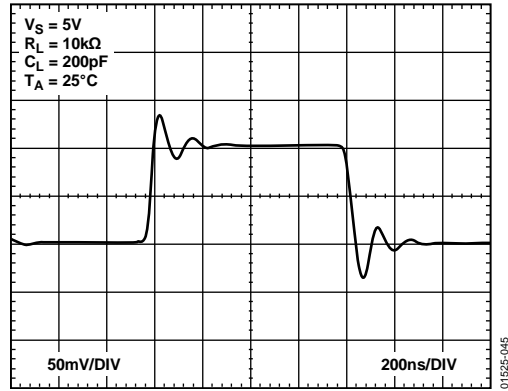

Figure 45. Small Signal Transient Response

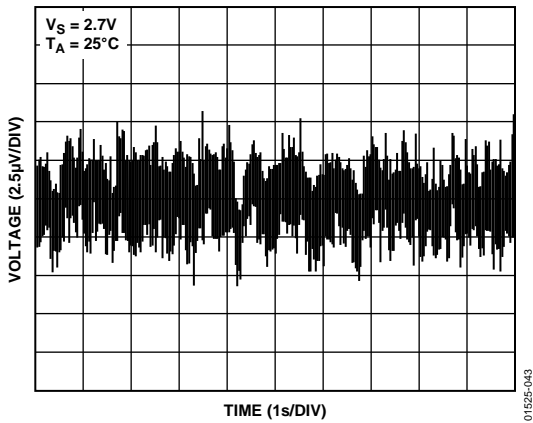

Figure 43. 0.1 Hz to 10 Hz Input Voltage Noise

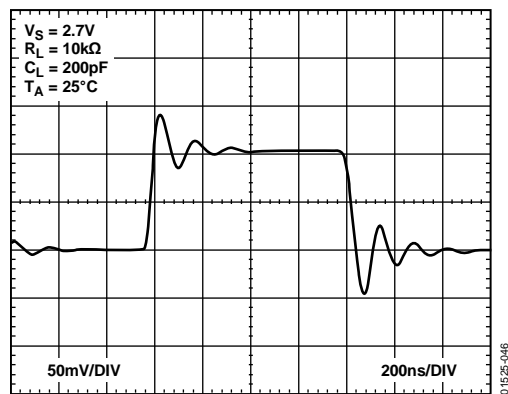

Figure 46. Small Signal Transient Response

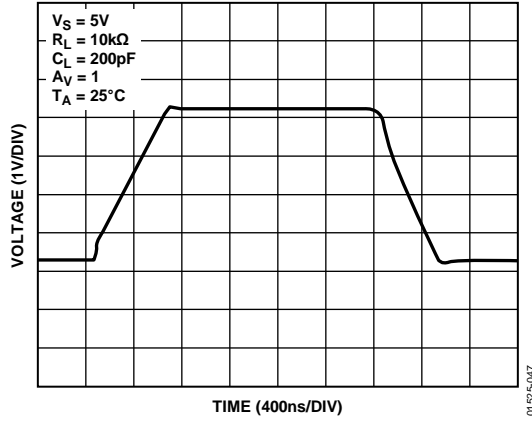

Figure 47. Large Signal Transient Response

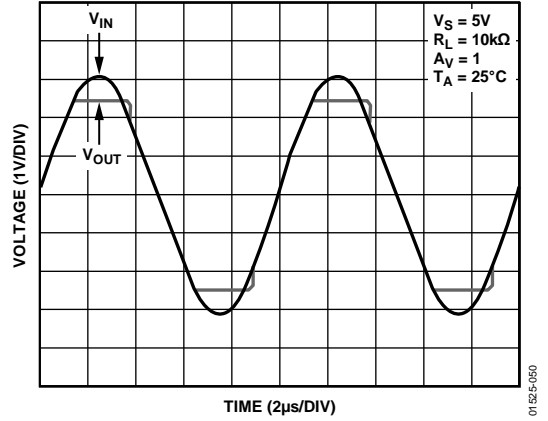

Figure 50. No Phase Reversal

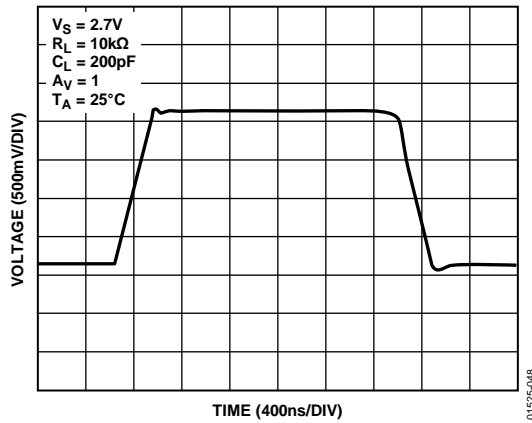

Figure 48. Large Signal Transient Response

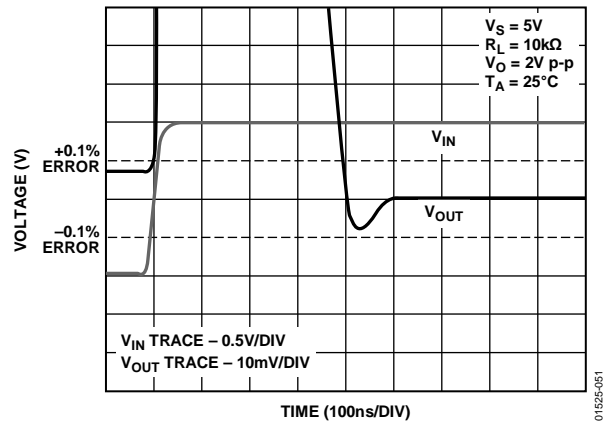

Figure 51. Settling Time

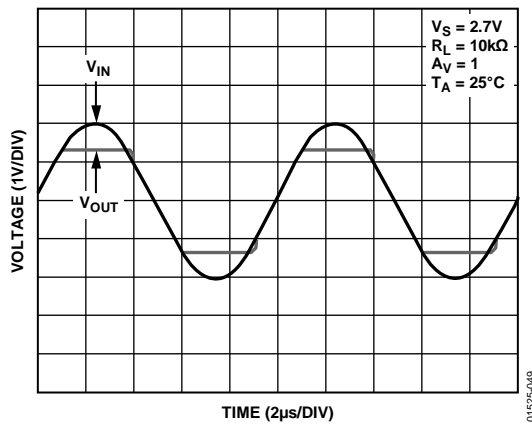

Figure 49. No Phase Reversal

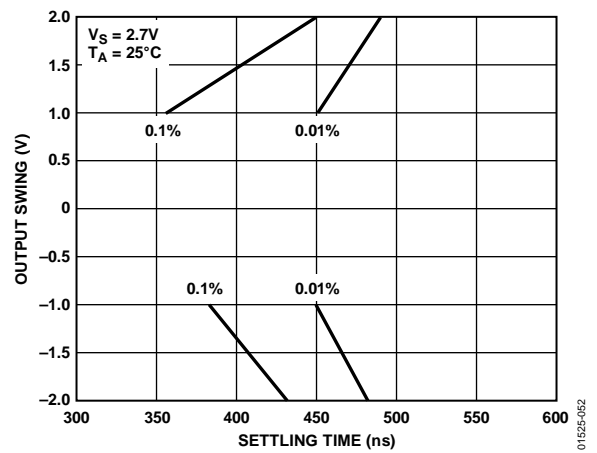

Figure 52. Output Swing vs. Settling Time

# AD8601/AD8602/AD8604

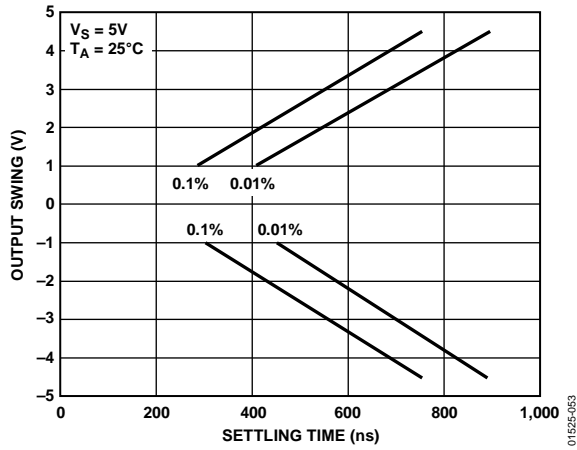

Figure 53. Output Swing vs. Settling Time

## THEORY OF OPERATION

The AD8601/AD8602/AD8604 family of amplifiers are rail-to-rail input and output, precision CMOS amplifiers that operate from 2.7 V to 5.0 V of the power supply voltage. These amplifiers use Analog Devices, Inc., DigiTrim® technology to achieve a higher degree of precision than available from most CMOS amplifiers. DigiTrim technology is a method of trimming the offset voltage of the amplifier after it has been assembled. The advantage in post-package trimming lies in the fact that it corrects any offset voltages due to the mechanical stresses of assembly. This technology is scalable and used with every package option, including the 5-lead SOT-23, providing lower offset voltages than previously achieved in these small packages.

The DigiTrim process is completed at the factory and does not add additional pins to the amplifier. All AD860x amplifiers are available in standard op amp pinouts, making DigiTrim completely transparent to the user. The AD860x can be used in any precision op amp application.

The input stage of the amplifier is a true rail-to-rail architecture, allowing the input common-mode voltage range of the op amp to extend to both positive and negative supply rails. The voltage swing of the output stage is also rail-to-rail and is achieved by using an NMOS and PMOS transistor pair connected in a common-source configuration. The maximum output voltage swing is proportional to the output current, and larger currents limit how close the output voltage can get to the supply rail, which is a characteristic of all rail-to-rail output amplifiers. With 1 mA of output current, the output voltage can reach within 20 mV of the positive rail and within 15 mV of the negative rail. At light loads of >100 k $\Omega$ , the output swings within ~1 mV of the supplies.

The open-loop gain of the AD860x is 80 dB, typical, with a load of 2 k $\Omega$ . Because of the rail-to-rail output configuration, the gain of the output stage and the open-loop gain of the amplifier are dependent on the load resistance. Open-loop gain decreases with smaller load resistances. Again, this is a characteristic inherent to all rail-to-rail output amplifiers.

### RAIL-TO-RAIL INPUT STAGE

The input common-mode voltage range of the AD860x extends to both the positive and negative supply voltages. This maximizes the usable voltage range of the amplifier, an important feature for single-supply and low voltage applications. This rail-to-rail input range is achieved by using two input differential pairs, one NMOS and one PMOS, placed in parallel. The NMOS pair is active at the upper end of the common-mode voltage range, and the PMOS pair is active at the lower end.

The NMOS and PMOS input stages are separately trimmed using DigiTrim to minimize the offset voltage in both differential pairs. Both NMOS and PMOS input differential pairs are active in a 500 mV transition region, when the input common-mode voltage is between approximately 1.5 V and 1 V below the positive supply voltage. The input offset voltage shifts slightly in this transition region, as shown in Figure 9 and Figure 10. The common-mode rejection ratio is also slightly lower when the input common-mode voltage is within this transition band. Compared to the Burr-Brown OPA2340UR rail-to-rail input amplifier, shown in Figure 54, the AD860x, shown in Figure 55, exhibits lower offset voltage shift across the entire input common-mode range, including the transition region.

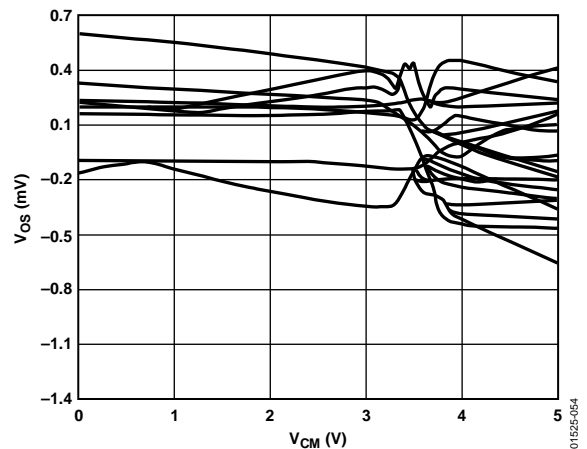

Figure 54. Burr-Brown OPA2340UR Input Offset Voltage vs. Common-Mode Voltage, 24 SOIC Units @ 25°C

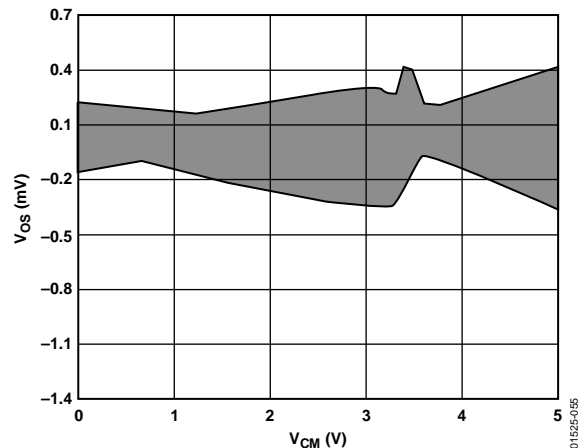

Figure 55. AD8602AR Input Offset Voltage vs. Common-Mode Voltage, 300 SOIC Units @ 25°C

# AD8601/AD8602/AD8604

## INPUT OVERVOLTAGE PROTECTION

As with any semiconductor device, if a condition could exist that could cause the input voltage to exceed the power supply, the device's input overvoltage characteristic must be considered. Excess input voltage energizes the internal PN junctions in the AD860x, allowing current to flow from the input to the supplies.

This input current does not damage the amplifier, provided it is limited to 5 mA or less. This can be ensured by placing a resistor in series with the input. For example, if the input voltage could exceed the supply by 5 V, the series resistor should be at least  $(5\text{ V}/5\text{ mA}) = 1\text{ k}\Omega$ . With the input voltage within the supply rails, a minimal amount of current is drawn into the inputs, which, in turn, causes a negligible voltage drop across the series resistor. Therefore, adding the series resistor does not adversely affect circuit performance.

## OVERDRIVE RECOVERY

Overdrive recovery is defined as the time it takes the output of an amplifier to come off the supply rail when recovering from an overload signal. This is tested by placing the amplifier in a closed-loop gain of 10 with an input square wave of 2 V p-p while the amplifier is powered from either 5 V or 3 V.

The AD860x has excellent recovery time from overload conditions. The output recovers from the positive supply rail within 200 ns at all supply voltages. Recovery from the negative rail is within 500 ns at a 5 V supply, decreasing to within 350 ns when the device is powered from 2.7 V.

## POWER-ON TIME

The power-on time is important in portable applications where the supply voltage to the amplifier may be toggled to shut down the device to improve battery life. Fast power-up behavior ensures that the output of the amplifier quickly settles to its final voltage, improving the power-up speed of the entire system. When the supply voltage reaches a minimum of 2.5 V, the AD860x settles to a valid output within 1  $\mu$ s. This turn-on response time is faster than many other precision amplifiers, which can take tens or hundreds of microseconds for their outputs to settle.

## USING THE AD8602 IN HIGH SOURCE IMPEDANCE APPLICATIONS

The CMOS rail-to-rail input structure of the AD860x allows these amplifiers to have very low input bias currents, typically 0.2 pA. This allows the AD860x to be used in any application that has a high source impedance or must use large value resistances around the amplifier. For example, the photodiode amplifier circuit shown in Figure 56 requires a low input bias current op amp to reduce output voltage error. The AD8601 minimizes offset errors due to its low input bias current and low offset voltage.

The current through the photodiode is proportional to the incident light power on its surface. The 4.7 M $\Omega$  resistor converts this current into a voltage, with the output of the AD8601 increasing at 4.7 V/ $\mu$ A. The feedback capacitor reduces excess noise at higher frequencies by limiting the bandwidth of the circuit to

$$BW = \frac{1}{2\pi(4.7\text{ M}\Omega)C_F} \quad (1)$$

Using a 10 pF feedback capacitor limits the bandwidth to approximately 3.3 kHz.

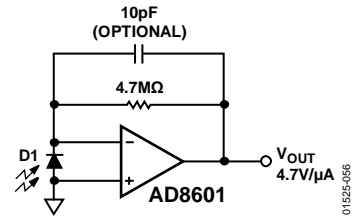

Figure 56. Amplifier Photodiode Circuit

## HIGH SIDE AND LOW SIDE, PRECISION CURRENT MONITORING

Because of its low input bias current and low offset voltage, the AD860x can be used for precision current monitoring. The true rail-to-rail input feature of the AD860x allows the amplifier to monitor current on either the high side or the low side. Using both amplifiers in an AD8602 provides a simple method for monitoring both current supply and return paths for load or fault detection. Figure 57 and Figure 58 demonstrate both circuits.

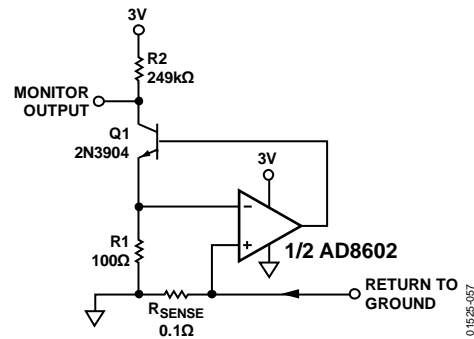

Figure 57. Low-Side Current Monitor

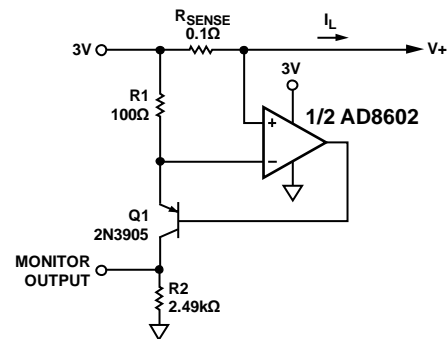

Figure 58. High-Side Current Monitor



Voltage drop is created across the  $0.1\ \Omega$  resistor that is proportional to the load current. This voltage appears at the inverting input of the amplifier due to the feedback correction around the op amp. This creates a current through  $R1$ , which in turn, pulls current through  $R2$ . For the low side monitor, the monitor output voltage is given by

$$\text{Monitor Output} = 3\text{ V} - \left[ R2 \times \left( \frac{R_{\text{SENSE}}}{R1} \right) \times I_L \right] \quad (2)$$

For the high side monitor, the monitor output voltage is

$$\text{Monitor Output} = R2 \times \left( \frac{R_{\text{SENSE}}}{R1} \right) \times I_L \quad (3)$$

Using the components shown, the monitor output transfer function is  $2.5\ \text{V/A}$ .

## USING THE AD8601 IN SINGLE-SUPPLY, MIXED SIGNAL APPLICATIONS

Single-supply, mixed signal applications requiring 10 or more bits of resolution demand both a minimum of distortion and a maximum range of voltage swing to optimize performance. To ensure that the ADCs or DACs achieve their best performance, an amplifier often must be used for buffering or signal conditioning. The  $750\ \mu\text{V}$  maximum offset voltage of the AD8601 allows the amplifier to be used in 12-bit applications powered from a  $3\ \text{V}$  single supply, and its rail-to-rail input and output ensure no signal clipping.

Figure 59 shows the AD8601 used as an input buffer amplifier to the AD7476, a 12-bit, 1 MSPS ADC. As with most ADCs, total harmonic distortion (THD) increases with higher source impedances. By using the AD8601 in a buffer configuration, the low output impedance of the amplifier minimizes THD while the high input impedance and low bias current of the op amp minimizes errors due to source impedance. The  $8\ \text{MHz}$  gain bandwidth product of the AD8601 ensures no signal attenuation up to  $500\ \text{kHz}$ , which is the maximum Nyquist frequency for the AD7476.

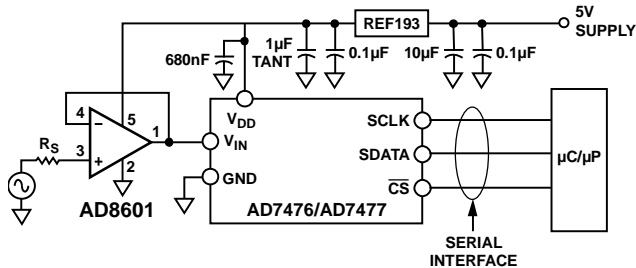

Figure 59. A Complete 3 V 12-Bit 1 MHz Analog-to-Digital Conversion System

Figure 60 demonstrates how the AD8601 can be used as an output buffer for the DAC for driving heavy resistive loads. The AD5320 is a 12-bit DAC that can be used with clock frequencies up to  $30\ \text{MHz}$  and signal frequencies up to  $930\ \text{kHz}$ . The rail-to-rail output of the AD8601 allows it to swing within  $100\ \text{mV}$  of the positive supply rail while sourcing  $1\ \text{mA}$  of current. The total current drawn from the circuit is less than  $1\ \text{mA}$ , or  $3\ \text{mW}$  from a  $3\ \text{V}$  single supply.

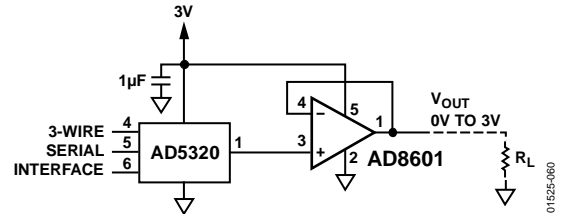

Figure 60. Using the AD8601 as a DAC Output Buffer to Drive Heavy Loads

The AD8601, AD7476, and AD5320 are all available in space-saving SOT-23 packages.

## PC100 COMPLIANCE FOR COMPUTER AUDIO APPLICATIONS

Because of its low distortion and rail-to-rail input and output, the AD860x is an excellent choice for low cost, single-supply audio applications, ranging from microphone amplification to line output buffering. Figure 38 shows the total harmonic distortion plus noise (THD + N) figures for the AD860x. In unity gain, the amplifier has a typical THD + N of  $0.004\%$ , or  $-86\ \text{dB}$ , even with a load resistance of  $600\ \Omega$ . This is compliant with the PC100 specification requirements for audio in both portable and desktop computers.

Figure 61 shows how an AD8602 can be interfaced with an AC'97 codec to drive the line output. Here, the AD8602 is used as a unity-gain buffer from the left and right outputs of the AC'97 codec. The  $100\ \mu\text{F}$  output coupling capacitors block dc current and the  $20\ \Omega$  series resistors protect the amplifier from short circuits at the jack.

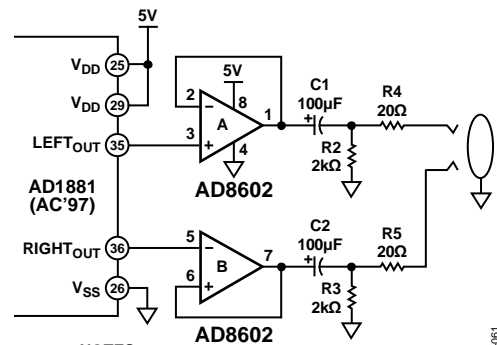

NOTES  
1. ADDITIONAL PINS OMITTED FOR CLARITY.

Figure 61. A PC100-Compliant Line Output Amplifier

## AD8601/AD8602/AD8604

### SPICE MODEL

The SPICE macro-model for the AD860x amplifier can be downloaded at [www.analog.com](http://www.analog.com). The model accurately simulates a number of both dc and ac parameters, including open-loop gain, bandwidth, phase margin, input voltage range, output voltage swing vs. output current, slew rate, input voltage noise, CMRR, PSRR, and supply current vs. supply voltage. The model is optimized for performance at 27°C. Although it functions at different temperatures, it may lose accuracy with respect to the actual behavior of the AD860x.

OUTLINE DIMENSIONS

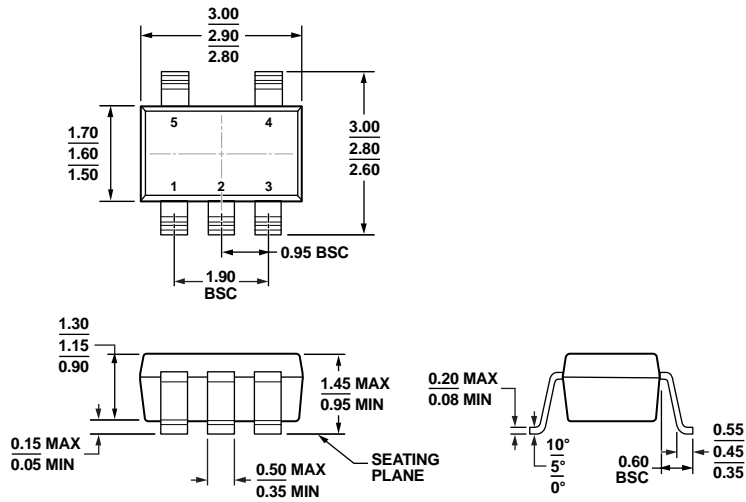

COMPLIANT TO JEDEC STANDARDS MO-178-AA

Figure 62. 5-Lead Small Outline Transistor Package [SOT-23] (RJ-5)

Dimensions shown in millimeters

11-01-2010-A

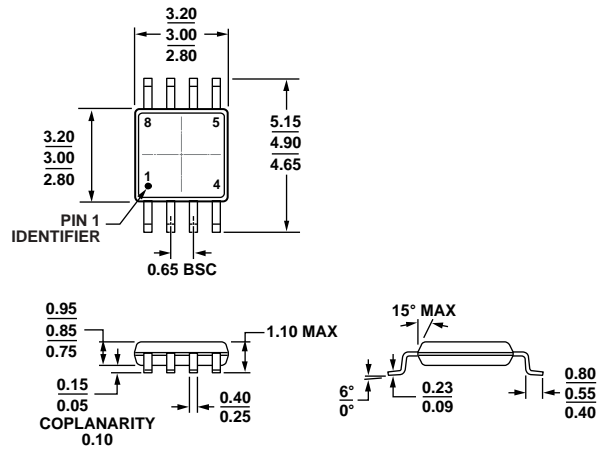

COMPLIANT TO JEDEC STANDARDS MO-187-AA

Figure 63. 8-Lead Mini Small Outline Package [MSOP] (RM-8)

Dimensions shown in millimeters

10-07-2009-B

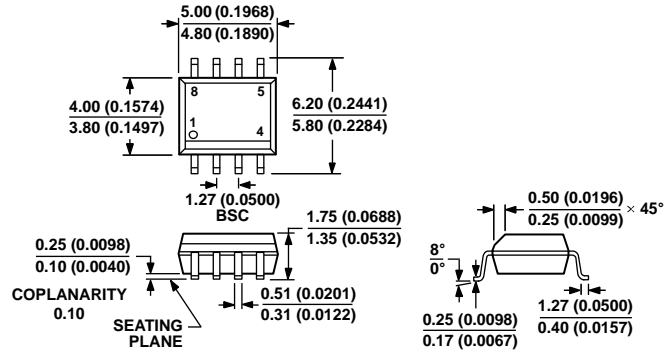

COMPLIANT TO JEDEC STANDARDS MS-012-AA  
 CONTROLLING DIMENSIONS ARE IN MILLIMETERS; INCH DIMENSIONS  
 (IN PARENTHESES) ARE ROUNDED-OFF MILLIMETER EQUIVALENTS FOR  
 REFERENCE ONLY AND ARE NOT APPROPRIATE FOR USE IN DESIGN.

Figure 64. 8-Lead Standard Small Outline Package [SOIC\_N]  
 (R-8)

Dimensions shown in millimeters and (inches)

012407-A

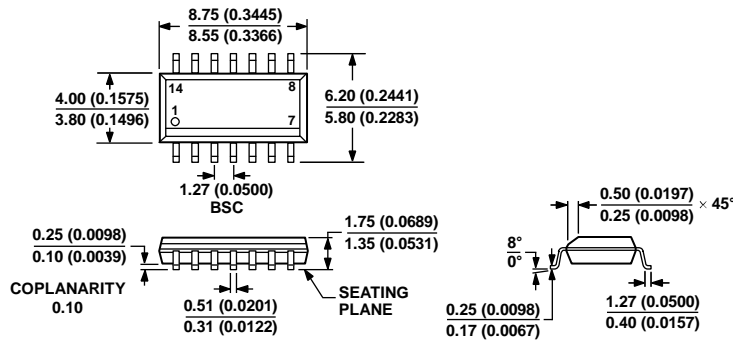

COMPLIANT TO JEDEC STANDARDS MS-012-AB  
 CONTROLLING DIMENSIONS ARE IN MILLIMETERS; INCH DIMENSIONS  
 (IN PARENTHESES) ARE ROUNDED-OFF MILLIMETER EQUIVALENTS FOR  
 REFERENCE ONLY AND ARE NOT APPROPRIATE FOR USE IN DESIGN.

Figure 65. 14-Lead Standard Small Outline Package [SOIC\_N]  
 (R-14)

Dimensions shown in millimeters and (inches)

060606-A

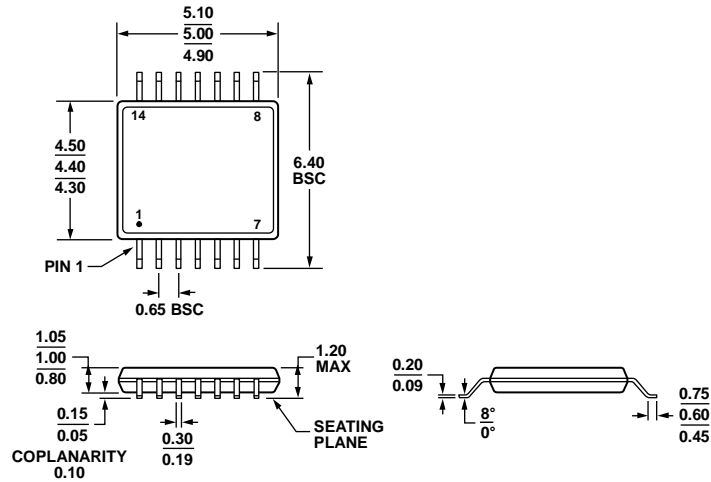

COMPLIANT TO JEDEC STANDARDS MO-153-AB-1

Figure 66. 14-Lead Thin Shrink Small Outline Package [TSSOP] (RU-14)

Dimensions shown in millimeters

061908-A

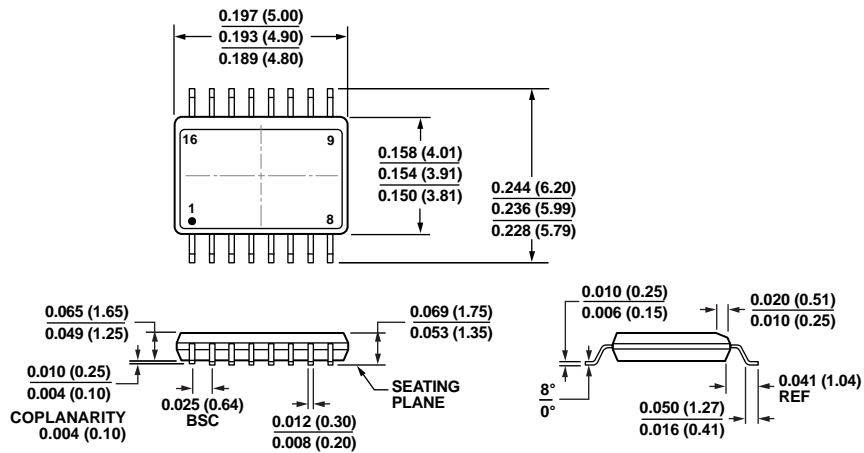

COMPLIANT TO JEDEC STANDARDS MO-137-AB

CONTROLLING DIMENSIONS ARE IN INCHES; MILLIMETER DIMENSIONS (IN PARENTHESES) ARE ROUNDED-OFF INCH EQUIVALENTS FOR REFERENCE ONLY AND ARE NOT APPROPRIATE FOR USE IN DESIGN.

Figure 67. 16-Lead Shrink Small Outline Package [QSOP] (RQ-16)

Dimensions shown in inches and (millimeters)

01-28-2006-A

# AD8601/AD8602/AD8604

## ORDERING GUIDE

Model <sup>1, 2</sup>	Temperature Range	Package Description	Package Option	Branding
AD8601ARTZ-R2	-40°C to +125°C	5-Lead SOT-23	RJ-5	AAA
AD8601ARTZ-REEL	-40°C to +125°C	5-Lead SOT-23	RJ-5	AAA
AD8601ARTZ-REEL7	-40°C to +125°C	5-Lead SOT-23	RJ-5	AAA
AD8601WARTZ-RL	-40°C to +125°C	5-Lead SOT-23	RJ-5	AAA
AD8601WARTZ-R7	-40°C to +125°C	5-Lead SOT-23	RJ-5	AAA
AD8601WDRTZ-REEL	-40°C to +125°C	5-Lead SOT-23	RJ-5	AAD
AD8601WDRTZ-REEL7	-40°C to +125°C	5-Lead SOT-23	RJ-5	AAD
AD8602AR	-40°C to +125°C	8-Lead SOIC_N	R-8	
AD8602AR-REEL	-40°C to +125°C	8-Lead SOIC_N	R-8	
AD8602AR-REEL7	-40°C to +125°C	8-Lead SOIC_N	R-8	
AD8602ARZ	-40°C to +125°C	8-Lead SOIC_N	R-8	
AD8602ARZ-REEL	-40°C to +125°C	8-Lead SOIC_N	R-8	
AD8602ARZ-REEL7	-40°C to +125°C	8-Lead SOIC_N	R-8	
AD8602WARZ-RL	-40°C to +125°C	8-Lead SOIC_N	R-8	
AD8602WARZ-R7	-40°C to +125°C	8-Lead SOIC_N	R-8	
AD8602ARM-REEL	-40°C to +125°C	8-Lead MSOP	RM-8	ABA
AD8602ARMZ	-40°C to +125°C	8-Lead MSOP	RM-8	ABA
AD8602ARMZ-REEL	-40°C to +125°C	8-Lead MSOP	RM-8	ABA
AD8602DR	-40°C to +125°C	8-Lead SOIC_N	R-8	
AD8602DR-REEL	-40°C to +125°C	8-Lead SOIC_N	R-8	
AD8602DR-REEL7	-40°C to +125°C	8-Lead SOIC_N	R-8	
AD8602DRZ	-40°C to +125°C	8-Lead SOIC_N	R-8	
AD8602DRZ-REEL	-40°C to +125°C	8-Lead SOIC_N	R-8	
AD8602DRZ-REEL7	-40°C to +125°C	8-Lead SOIC_N	R-8	
AD8602DRM-REEL	-40°C to +125°C	8-Lead MSOP	RM-8	ABD
AD8602DRMZ-REEL	-40°C to +125°C	8-Lead MSOP	RM-8	ABD
AD8604ARZ	-40°C to +125°C	14-Lead SOIC_N	R-14	
AD8604ARZ-REEL	-40°C to +125°C	14-Lead SOIC_N	R-14	
AD8604ARZ-REEL7	-40°C to +125°C	14-Lead SOIC_N	R-14	
AD8604DRZ	-40°C to +125°C	14-Lead SOIC_N	R-14	
AD8604DRZ-REEL	-40°C to +125°C	14-Lead SOIC_N	R-14	
AD8604ARUZ	-40°C to +125°C	14-Lead TSSOP	RU-14	
AD8604ARUZ-REEL	-40°C to +125°C	14-Lead TSSOP	RU-14	
AD8604DRU	-40°C to +125°C	14-Lead TSSOP	RU-14	
AD8604DRU -REEL	-40°C to +125°C	14-Lead TSSOP	RU-14	
AD8604DRUZ	-40°C to +125°C	14-Lead TSSOP	RU-14	
AD8604DRUZ-REEL	-40°C to +125°C	14-Lead TSSOP	RU-14	
AD8604ARQZ	-40°C to +125°C	16-Lead QSOP	RQ-16	
AD8604ARQZ-RL	-40°C to +125°C	16-Lead QSOP	RQ-16	
AD8604ARQZ-R7	-40°C to +125°C	16-Lead QSOP	RQ-16	

<sup>1</sup> Z = RoHS Compliant Part.

<sup>2</sup> W = Qualified for Automotive Applications.

## AUTOMOTIVE PRODUCTS

The AD8601W/AD8602W models are available with controlled manufacturing to support the quality and reliability requirements of automotive applications. Note that these automotive models may have specifications that differ from the commercial models; therefore, designers should review the Specifications section of this data sheet carefully. Only the automotive grade products shown are available for use in automotive applications. Contact your local Analog Devices Account Representative for specific product ordering information and to obtain the specific Automotive Reliability reports for these models.

**NOTES**

**NOTES**