

# MCR22-6, MCR22-8

Preferred Device

## Sensitive Gate Silicon Controlled Rectifiers Reverse Blocking Thyristors

Designed and tested for repetitive peak operation required for CD ignition, fuel ignitors, flash circuits, motor controls and low-power switching applications.

### Features

- 150 A for 2  $\mu$ s Safe Area
- High dv/dt
- Very Low Forward "On" Voltage at High Current
- Low-Cost TO-226 (TO-92)
- Pb-Free Packages are Available\*

**MAXIMUM RATINGS** ( $T_J = 25^\circ\text{C}$  unless otherwise noted)

Rating	Symbol	Value	Unit
Peak Repetitive Off-State Voltage (Note 1) ( $R_{GK} = 1\text{K}$ , $T_J = -40$ to $+110^\circ\text{C}$ , Sine Wave, 50 to 60 Hz, $R_{GK} = 1\text{k}\Omega$ ) MCR22-6 MCR22-8	$V_{DRM}$ , $V_{RRM}$	400 600	V
On-State Current RMS ( $180^\circ$ Conduction Angles, $T_C = 80^\circ\text{C}$ )	$I_T(\text{RMS})$	1.5	A
Peak Non-repetitive Surge Current, @ $T_A = 25^\circ\text{C}$ , (1/2 Cycle, Sine Wave, 60 Hz)	$I_{TSM}$	15	A
Circuit Fusing Considerations ( $t = 8.3$ ms)	$I^2t$	0.9	$\text{A}^2\text{s}$
Forward Peak Gate Power (Pulse Width $\leq 1.0$ $\mu\text{sec}$ , $T_A = 25^\circ\text{C}$ )	$P_{GM}$	0.5	W
Forward Average Gate Power ( $t = 8.3$ msec, $T_A = 25^\circ\text{C}$ )	$P_{G(AV)}$	0.1	W
Forward Peak Gate Current (Pulse Width $\leq 1.0$ $\mu\text{s}$ , $T_A = 25^\circ\text{C}$ )	$I_{FGM}$	0.2	A
Reverse Peak Gate Voltage (Pulse Width $\leq 1.0$ $\mu\text{s}$ , $T_A = 25^\circ\text{C}$ )	$V_{RGM}$	5.0	V
Operating Junction Temperature Range @ Rated $V_{RRM}$ and $V_{DRM}$	$T_J$	-40 to +110	$^\circ\text{C}$
Storage Temperature Range	$T_{stg}$	-40 to +150	$^\circ\text{C}$

### THERMAL CHARACTERISTICS

Characteristic	Symbol	Max	Unit
Thermal Resistance, Junction-to-Case	$R_{\theta JC}$	50	$^\circ\text{C}/\text{W}$
Thermal Resistance, Junction-to-Ambient	$R_{\theta JA}$	160	$^\circ\text{C}/\text{W}$
Lead Solder Temperature (Lead Length $\geq 1/16"$ from case, 10 S Max)	$T_L$	+260	$^\circ\text{C}$

Stresses exceeding Maximum Ratings may damage the device. Maximum Ratings are stress ratings only. Functional operation above the Recommended Operating Conditions is not implied. Extended exposure to stresses above the Recommended Operating Conditions may affect device reliability.

1.  $V_{DRM}$  and  $V_{RRM}$  for all types can be applied on a continuous basis. Ratings apply for zero or negative gate voltage; however, positive gate voltage shall not be applied concurrent with negative potential on the anode. Blocking voltages shall not be tested with a constant current source such that the voltage ratings of the devices are exceeded.

\*For additional information on our Pb-Free strategy and soldering details, please download the ON Semiconductor Soldering and Mounting Techniques Reference Manual, SOLDERRM/D.



**ON Semiconductor**<sup>®</sup>

<http://onsemi.com>

**SCRs**  
**1.5 AMPERES RMS**  
**400 thru 600 VOLTS**

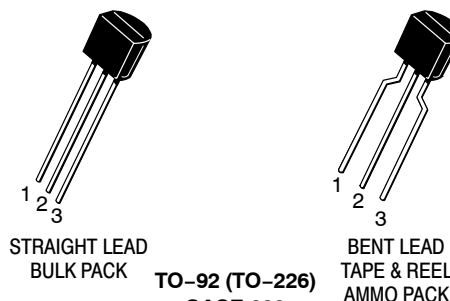

STRAIGHT LEAD BULK PACK TO-92 (TO-226) CASE 029 STYLE 10  
BENT LEAD TAPE & REEL AMMO PACK

### MARKING DIAGRAMS

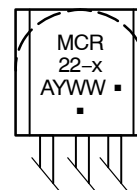

MCR22-x = Device Code  
x = 6 or 8  
A = Assembly Location  
Y = Year  
WW = Work Week  
▪ = Pb-Free Package

(Note: Microdot may be in either location)

### PIN ASSIGNMENT

Pin	Assignment
1	Cathode
2	Gate
3	Anode

### ORDERING INFORMATION

See detailed ordering and shipping information in the package dimensions section on page 7 of this data sheet.

**Preferred** devices are recommended choices for future use and best overall value.

# MCR22-6, MCR22-8

## ELECTRICAL CHARACTERISTICS (T<sub>C</sub> = 25°C unless otherwise noted.)

Characteristic	Symbol	Min	Typ	Max	Unit
----------------	--------	-----	-----	-----	------

### OFF CHARACTERISTICS

Peak Repetitive Forward or Reverse Blocking Current (V <sub>AK</sub> = Rated V <sub>DRM</sub> or V <sub>RRM</sub> ; R <sub>GK</sub> = 1 kΩ)	T <sub>C</sub> = 25°C T <sub>C</sub> = 110°C	I <sub>DRM</sub> , I <sub>RRM</sub>	- -	- -	10 200	μA μA
--	---	-------------------------------------	--------	--------	-----------	----------

### ON CHARACTERISTICS

Peak Forward On-State Voltage (Note 2) (I <sub>TM</sub> = 1 A Peak)		V <sub>TM</sub>	-	1.2	1.7	V
Gate Trigger Current (Continuous dc) (Note 3) (V <sub>AK</sub> = 6 Vdc, R <sub>L</sub> = 100 Ω)	T <sub>C</sub> = 25°C T <sub>C</sub> = -40°C	I <sub>GT</sub>	- -	30 -	200 500	μA
Gate Trigger Voltage (Continuous dc) (Note 3) (V <sub>AK</sub> = 7 Vdc, R <sub>L</sub> = 100 Ω)	T <sub>C</sub> = 25°C T <sub>C</sub> = -40°C	V <sub>GT</sub>	- -	- -	0.8 1.2	V
Gate Non-Trigger Voltage (V <sub>AK</sub> = 12 Vdc, R <sub>L</sub> = 100 Ω)	T <sub>C</sub> = 110°C	V <sub>GD</sub>	0.1	-	-	V
Holding Current (V <sub>AK</sub> = 12 Vdc, R <sub>GK</sub> = 1kΩ) Initiating Current = 20 mA	T <sub>C</sub> = 25°C T <sub>C</sub> = -40°C	I <sub>H</sub>	- -	2.0 -	5.0 10	mA

### DYNAMIC CHARACTERISTICS

Critical Rate of Rise of Off-State Voltage (R <sub>GK</sub> = 1kΩ) (T <sub>C</sub> = 110°C)		dv/dt	-	25	-	V/μs
--	--	-------	---	----	---	------

2. Pulse Width = 1.0 ms, Duty Cycle ≤ 1%.
3. R<sub>GK</sub> Current not included in measurement.

## Voltage Current Characteristic of SCR

Symbol	Parameter
V <sub>DRM</sub>	Peak Repetitive Off State Forward Voltage
I <sub>DRM</sub>	Peak Forward Blocking Current
V <sub>RRM</sub>	Peak Repetitive Off State Reverse Voltage
I <sub>RRM</sub>	Peak Reverse Blocking Current
V <sub>TM</sub>	Peak on State Voltage
I <sub>H</sub>	Holding Current

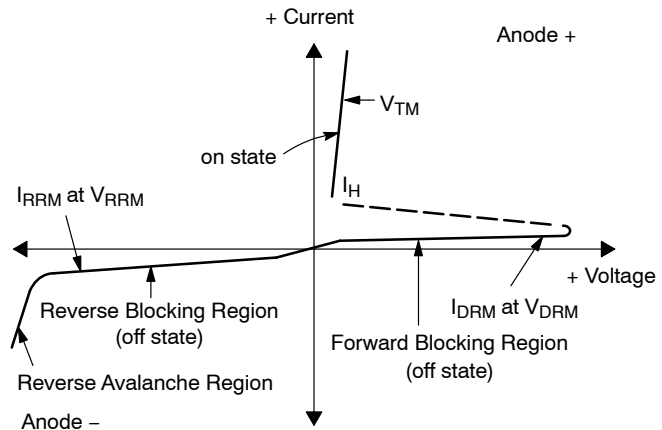

# MCR22-6, MCR22-8

## CURRENT DERATING

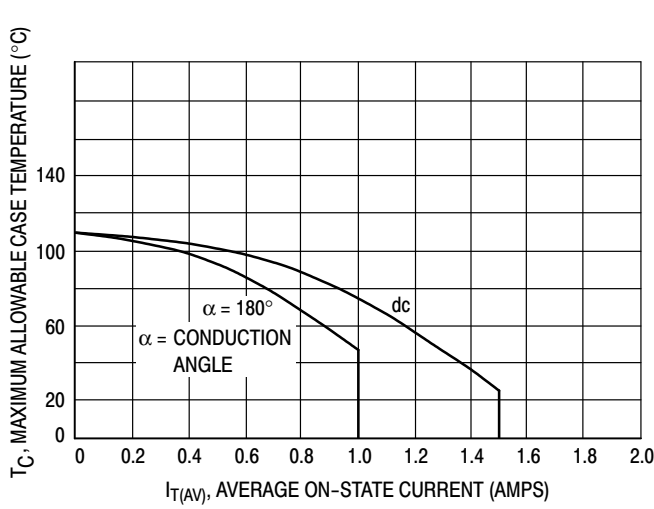

Figure 1. Maximum Case Temperature

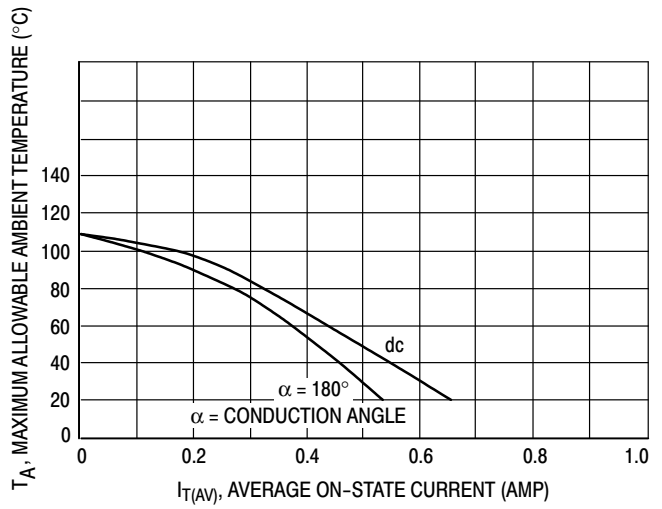

Figure 2. Maximum Ambient Temperature

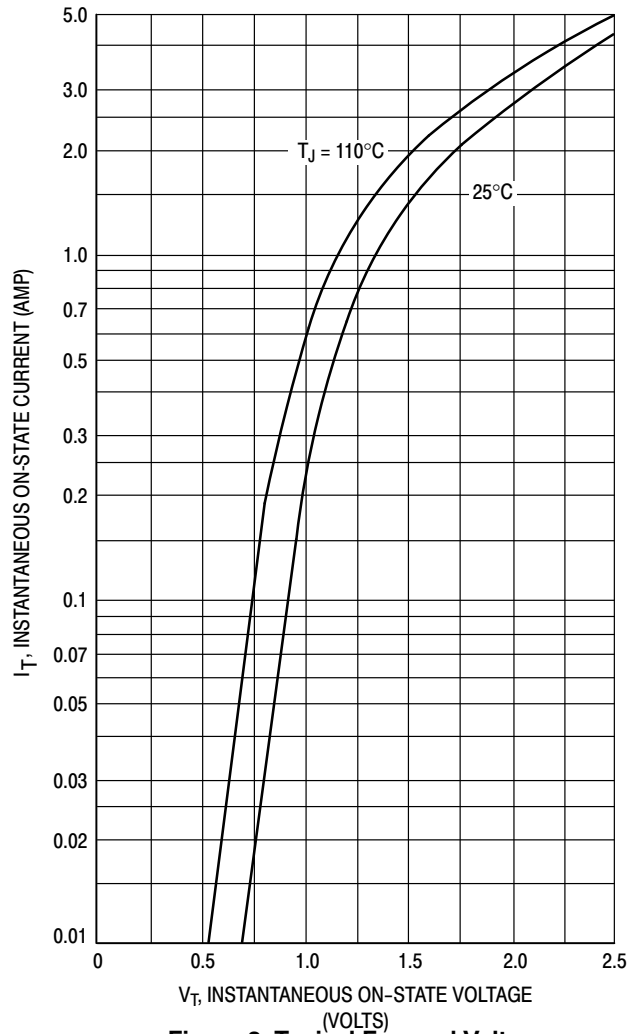

Figure 3. Typical Forward Voltage

# MCR22-6, MCR22-8

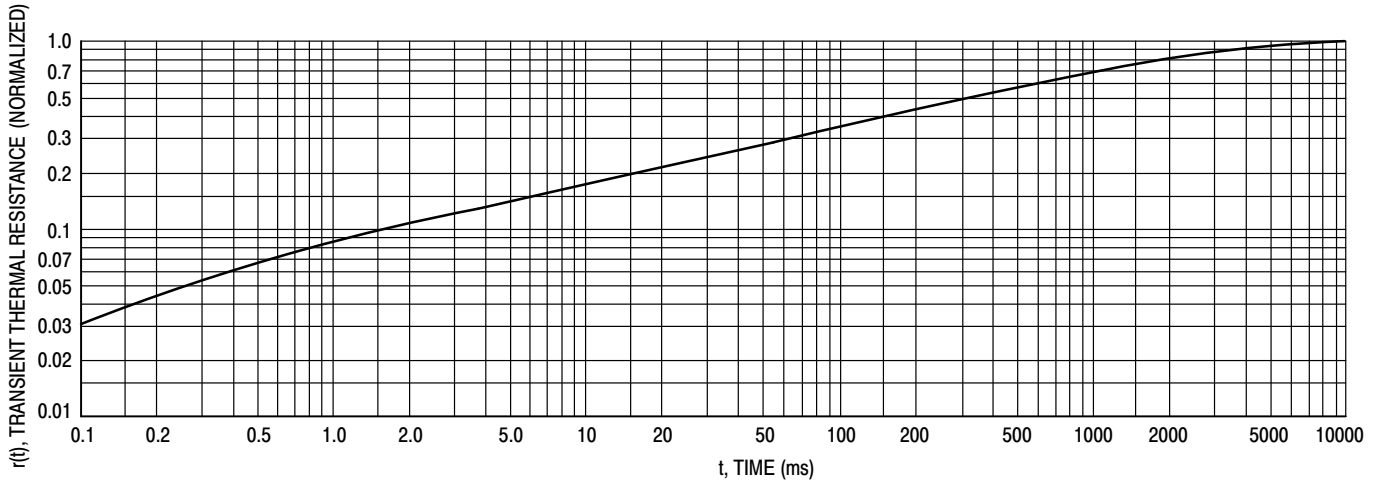

Figure 4. Thermal Response

## TYPICAL CHARACTERISTICS

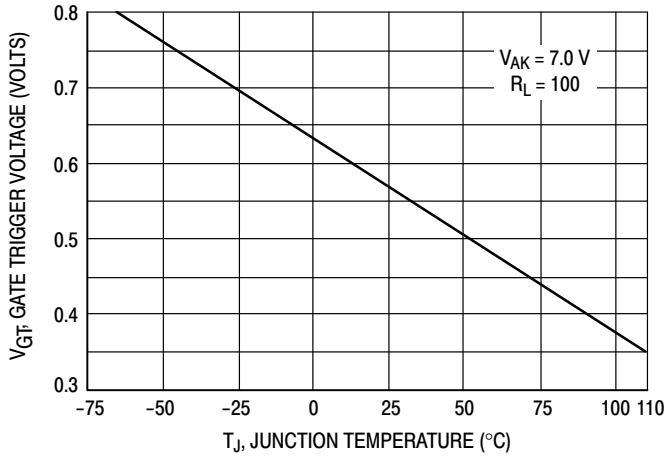

Figure 5. Typical Gate Trigger Voltage

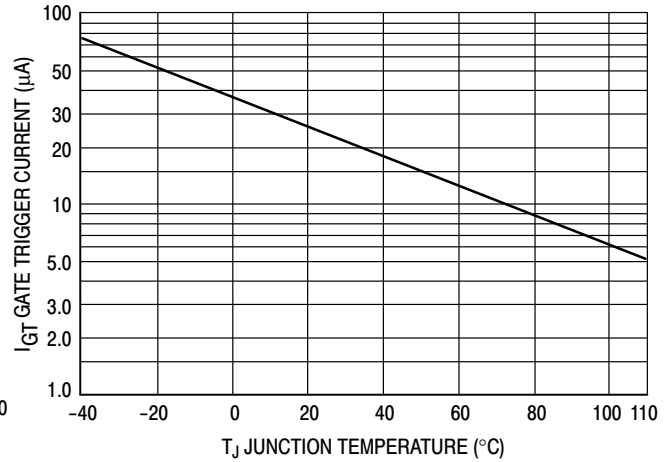

Figure 6. Typical Gate Trigger Current

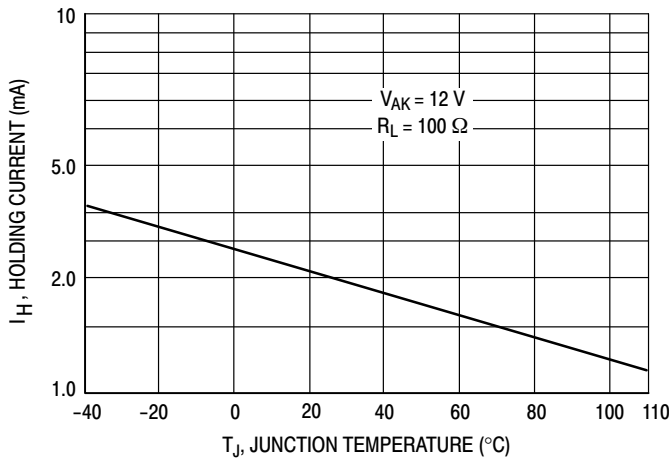

Figure 7. Typical Holding Current

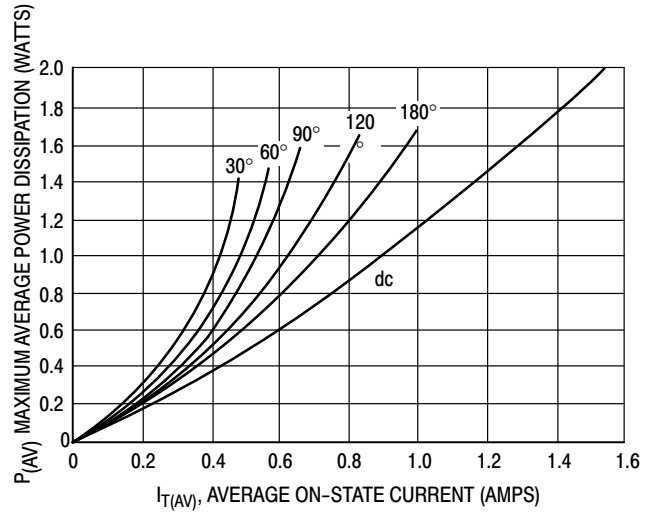

Figure 8. Power Dissipation

TO-92 EIA RADIAL TAPE IN FAN FOLD BOX OR ON REEL

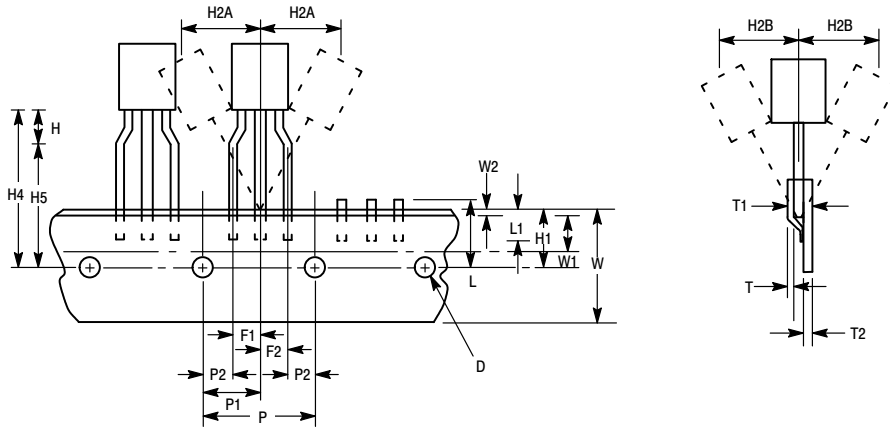

Figure 9. Device Positioning on Tape

Item	Symbol	Specification			
		Inches		Millimeter	
		Min	Max	Min	Max
Tape Feedhole Diameter	D	0.1496	0.1653	3.8	4.2
Component Lead Thickness Dimension	D2	0.015	0.020	0.38	0.51
Component Lead Pitch	F1, F2	0.0945	0.110	2.4	2.8
Bottom of Component to Seating Plane	H	.059	.156	1.5	4.0
Feedhole Location	H1	0.3346	0.3741	8.5	9.5
Deflection Left or Right	H2A	0	0.039	0	1.0
Deflection Front or Rear	H2B	0	0.051	0	1.0
Feedhole to Bottom of Component	H4	0.7086	0.768	18	19.5
Feedhole to Seating Plane	H5	0.610	0.649	15.5	16.5
Defective Unit Clipped Dimension	L	0.3346	0.433	8.5	11
Lead Wire Enclosure	L1	0.09842	-	2.5	-
Feedhole Pitch	P	0.4921	0.5079	12.5	12.9
Feedhole Center to Center Lead	P1	0.2342	0.2658	5.95	6.75
First Lead Spacing Dimension	P2	0.1397	0.1556	3.55	3.95
Adhesive Tape Thickness	T	0.06	0.08	0.15	0.20
Overall Taped Package Thickness	T1	-	0.0567	-	1.44
Carrier Strip Thickness	T2	0.014	0.027	0.35	0.65
Carrier Strip Width	W	0.6889	0.7481	17.5	19
Adhesive Tape Width	W1	0.2165	0.2841	5.5	6.3
Adhesive Tape Position	W2	.0059	0.01968	.15	0.5

NOTES:

1. Maximum alignment deviation between leads not to be greater than 0.2 mm.
2. Defective components shall be clipped from the carrier tape such that the remaining protrusion (L) does not exceed a maximum of 11 mm.
3. Component lead to tape adhesion must meet the pull test requirements.
4. Maximum non-cumulative variation between tape feed holes shall not exceed 1 mm in 20 pitches.
5. Holddown tape not to extend beyond the edge(s) of carrier tape and there shall be no exposure of adhesive.
6. No more than 1 consecutive missing component is permitted.
7. A tape trailer and leader, having at least three feed holes is required before the first and after the last component.
8. Splices will not interfere with the sprocket feed holes.

## MCR22-6, MCR22-8

### ORDERING & SHIPPING INFORMATION: MCR22 Series Packaging Options, Device Suffix

U.S.	Europe Equivalent	Shipping†	Description of TO-92 Tape Orientation
	MCR22-8RL1	2000 / Tape & Reel	Flat side of TO-92 and adhesive tape visible
	MCR22-8RL1G		
MCR22-6		5000 Units / Box	N/A, Bulk
MCR22-6G			
MCR22-8			
MCR22-8G			
MCR22-6RLRA		2000 / Tape & Reel	Round side of TO-92 and adhesive tape visible
MCR22-6RLRAG			
MCR22-6RLRP		2000 / Tape & Ammo Pack	Flat side of TO-92 and adhesive tape visible
MCR22-6RLRPG			

†For information on tape and reel specifications, including part orientation and tape sizes, please refer to our Tape and Reel Packaging Specifications Brochure, BRD8011/D.

# MCR22-6, MCR22-8

## PACKAGE DIMENSIONS

### TO-92 (TO-226) CASE 29-11 ISSUE AM

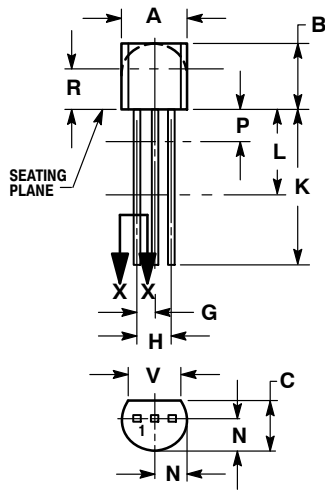

STRAIGHT LEAD  
BULK PACK

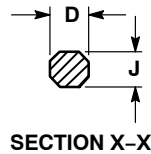

SECTION X-X

NOTES:

1. DIMENSIONING AND TOLERANCING PER ANSI Y14.5M, 1982.
2. CONTROLLING DIMENSION: INCH.
3. CONTOUR OF PACKAGE BEYOND DIMENSION R IS UNCONTROLLED.
4. LEAD DIMENSION IS UNCONTROLLED IN P AND BEYOND DIMENSION K MINIMUM.

DIM	INCHES		MILLIMETERS	
	MIN	MAX	MIN	MAX
A	0.175	0.205	4.45	5.20
B	0.170	0.210	4.32	5.33
C	0.125	0.165	3.18	4.19
D	0.016	0.021	0.407	0.533
G	0.045	0.055	1.15	1.39
H	0.095	0.105	2.42	2.66
J	0.015	0.020	0.39	0.50
K	0.500	---	12.70	---
L	0.250	---	6.35	---
N	0.080	0.105	2.04	2.66
P	---	0.100	---	2.54
R	0.115	---	2.93	---
V	0.135	---	3.43	---

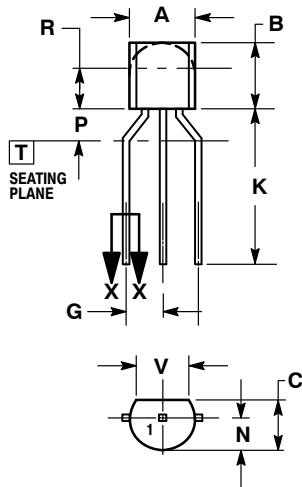

BENT LEAD  
TAPE & REEL  
AMMO PACK

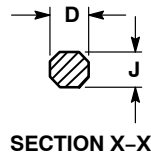

SECTION X-X

NOTES:

1. DIMENSIONING AND TOLERANCING PER ASME Y14.5M, 1994.
2. CONTROLLING DIMENSION: MILLIMETERS.
3. CONTOUR OF PACKAGE BEYOND DIMENSION R IS UNCONTROLLED.
4. LEAD DIMENSION IS UNCONTROLLED IN P AND BEYOND DIMENSION K MINIMUM.

DIM	MILLIMETERS	
	MIN	MAX
A	4.45	5.20
B	4.32	5.33
C	3.18	4.19
D	0.40	0.54
G	2.40	2.80
J	0.39	0.50
K	12.70	---
N	2.04	2.66
P	1.50	4.00
R	2.93	---
V	3.43	---

STYLE 10:

1. CATHODE
2. GATE
3. ANODE

ON Semiconductor and are registered trademarks of Semiconductor Components Industries, LLC (SCILLC). SCILLC reserves the right to make changes without further notice to any products herein. SCILLC makes no warranty, representation or guarantee regarding the suitability of its products for any particular purpose, nor does SCILLC assume any liability arising out of the application or use of any product or circuit, and specifically disclaims any and all liability, including without limitation special, consequential or incidental damages. "Typical" parameters which may be provided in SCILLC data sheets and/or specifications can and do vary in different applications and actual performance may vary over time. All operating parameters, including "Typicals" must be validated for each customer application by customer's technical experts. SCILLC does not convey any license under its patent rights nor the rights of others. SCILLC products are not designed, intended, or authorized for use as components in systems intended for surgical implant into the body, or other applications intended to support or sustain life, or for any other application in which the failure of the SCILLC product could create a situation where personal injury or death may occur. Should Buyer purchase or use SCILLC products for any such unintended or unauthorized application, Buyer shall indemnify and hold SCILLC and its officers, employees, subsidiaries, affiliates, and distributors harmless against all claims, costs, damages, and expenses, and reasonable attorney fees arising out of, directly or indirectly, any claim of personal injury or death associated with such unintended or unauthorized use, even if such claim alleges that SCILLC was negligent regarding the design or manufacture of the part. SCILLC is an Equal Opportunity/Affirmative Action Employer. This literature is subject to all applicable copyright laws and is not for resale in any manner.

### PUBLICATION ORDERING INFORMATION

**LITERATURE FULFILLMENT:**  
Literature Distribution Center for ON Semiconductor  
P.O. Box 5163, Denver, Colorado 80217 USA  
**Phone:** 303-675-2175 or 800-344-3860 Toll Free USA/Canada  
**Fax:** 303-675-2176 or 800-344-3867 Toll Free USA/Canada  
**Email:** orderlit@onsemi.com

**N. American Technical Support:** 800-282-9855 Toll Free  
USA/Canada  
**Europe, Middle East and Africa Technical Support:**  
Phone: 421 33 790 2910  
**Japan Customer Focus Center**  
Phone: 81-3-5773-3850

**ON Semiconductor Website:** [www.onsemi.com](http://www.onsemi.com)  
**Order Literature:** <http://www.onsemi.com/orderlit>  
For additional information, please contact your local  
Sales Representative