

## Low $I_Q$ , Low Dropout 500mA Fixed Voltage Regulator

### Features

- **Low Noise** :  $50\text{mV}_{\text{RMS}}$  (100Hz to 100kHz)
- **Low Quiescent Current** : 50mA (No load)
- **Low Dropout Voltage** : 170mV (@500mA)
- **Very Low Shutdown Current** : < 0.5mA
- **Fixed Output Voltage** : 1.3V ~ 3.4V
- **Stable with 4.7mF Output Capacitor**
- **Stable with Aluminum, Tantalum, or Ceramic Capacitors**
- **Reverse Current Protection**
- **No Protection Diodes Needed**
- **Built-In Thermal Protection**
- **Built-In Current-Limit Protection**
- **Controlled Short Circuit Current** : 150mA
- **Fast Transient Response**
- **Short Setting Time**
- **SOT-23-5, SOT-89, SOT-89-5, SOT-223, SOP-8 TO-252-3, and TO-252-5 Packages**
- **Lead Free and Green Devices Available (RoHS Compliant)**

### General Description

The APL5501/2/3 are micropower, low noise, low dropout linear regulators. Operate from 2.7V to 6V input voltage and deliver up to 500mA. Typical output noise is just  $50\mu\text{V}_{\text{RMS}}$  with the addition of an external  $0.1\mu\text{F}$  bypass capacitor in BP pin and typical dropout voltage is only 170mV at 500mA loading. Designed for use in battery-powered system, the low  $50\mu\text{A}$  quiescent current makes it an ideal choice.

Design with an internal P-channel MOSFET pass transistor, the APL5501/2/3 maintain a low supply current, independent of the load current and dropout voltage. Other features include reverse current protection, thermal-shutdown protection, and current-limit protection to ensure specified output current and controlled short-circuit current. The APL5501/2/3 regulators come in a miniature SOT-23-5, SOT-89, SOT-89-5, SOT-223, SOP-8, TO-252-3, and TO-252-5 packages.

### Applications

- **Notebook Computer**
- **PDA or Portable Equipments**
- **Noise-Sensitive Instrumentation Systems**

### Pin Configuration

#### APL5501

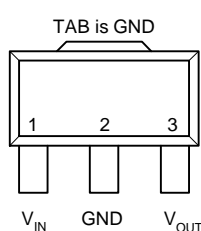

SOT-89 (Top View)

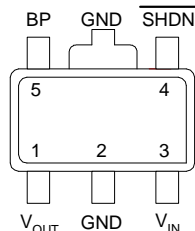

SOT-89-5 (Top View)

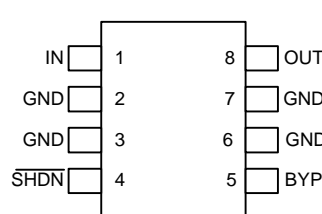

SOP-8 (Top View)

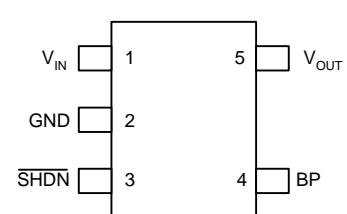

SOT-23-5 (Top View)

ANPEC reserves the right to make changes to improve reliability or manufacturability without notice, and advise customers to obtain the latest version of relevant information to verify before placing orders.

## Pin Configuration (Cont.)

### APL5501

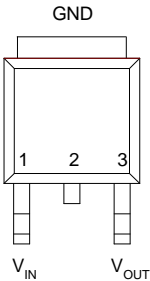

TO-252-3 (Top View)

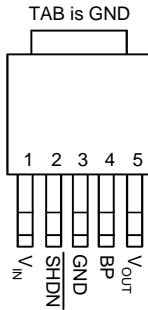

TO-252-5 (Top View)

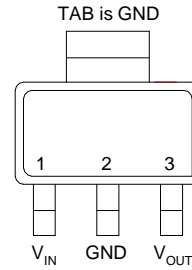

SOT-223 (Top View)

### APL5502

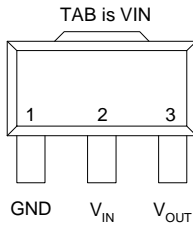

SOT-89 (Top View)

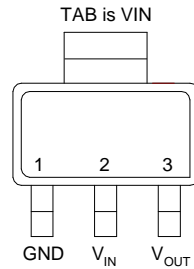

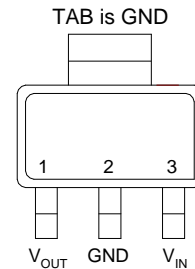

SOT-223 (Top View)

### APL5503

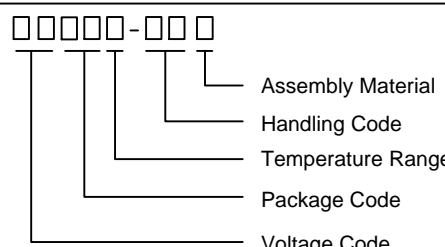
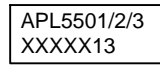

SOT-223 (Top View)

## Ordering and Marking Information

<p>APL5501/2/3 </p>	<p>Package Code                  B : SOT-23-5    D : SOT-89    D5 : SOT-89-5                  U : TO-252-3    U5 : TO-252-5    V : SOT-223                  K : SOP-8                  Operating Ambient Temperature Range                  C : 0 to 70 °C                  Handling Code                  TR : Tape &amp; Reel                  Voltage Code :                  13 : 1.3V ~ 34 : 3.4V                  Assembly Material                  G : Halogen and Lead Free Device</p>
<p>APL5501/2/3 - 13 D/V/K : </p>	<p>XXXXX - Date Code , 13 - 1.3V</p>
<p>APL5501/2/3 - 13 U : </p>	<p>XXXXX - Date Code , 13 - 1.3V</p>

Note: ANPEC lead-free products contain molding compounds/die attach materials and 100% matte tin plate termination finish; which are fully compliant with RoHS. ANPEC lead-free products meet or exceed the lead-free requirements of IPC/JEDEC J-STD-020C for MSL classification at lead-free peak reflow temperature. ANPEC defines "Green" to mean lead-free (RoHS compliant) and halogen free (Br or Cl does not exceed 900ppm by weight in homogeneous material and total of Br and Cl does not exceed 1500ppm by weight).

## Marking Information

SOT-23-5 package

Product Name	Marking	Product Name	Marking	Product Name	Marking
APL5501-13B	517X	APL5501-21B	51FX	APL5501-28B	51MX
APL5501-14B	518X	APL5501-22B	51GX	APL5501-29B	51NX
APL5501-15B	519X	APL5501-23B	51HX	APL5501-30B	51OX
APL5501-16B	51AX	APL5501-24B	51IX	APL5501-31B	51PX
APL5501-17B	51BX	APL5501-25B	51JX	APL5501-32B	51QX
APL5501-18B	51CX	APL5501-26B	51KX	APL5501-33B	51RX
APL5501-19B	51DX	APL5501-27B	51LX	APL5501-34B	51SX
APL5501-20B	51EX				

The last character "X" in the marking is for data code.

## Absolute Maximum Ratings

Symbol	Parameter	Rating	Unit
$V_{IN}, V_{OUT}$	Input Voltage or Out Voltage	6.5	V
$\overline{SHDN}$	Shutdown Control Pin	6.5	V
$P_D$	Power Dissipation	Internally Limited	W
$T_{STG}$	Storage Temperature Range	-65 to +150	°C
$T_L$	Maximum Lead Soldering Temperature, 10 Seconds	260	°C

## Thermal Characteristic

Symbol	Parameter	Typical Value	Unit
$R_{TH,JA}$	Thermal Resistance - Junction to Ambient	SOT-89	180
		SOT-223	135
		SOP-8	150
		SOT-23-5	260
$R_{TH,JC}$	Thermal Resistance - Junction to Case	SOT-89	38
		SOT-223	15
		SOP-8	20
		SOT-23-5	130
$T_J$	Operating Junction Temperature	Control Section	0 to 125
		Power Transistor	0 to 150

## Electrical Characteristics

Unless otherwise noted these specifications apply over full temperature,  $V_{IN}=3.6V$ ,  $C_{IN}=1\mu F$ ,  $C_{OUT}=4.7\mu F$ ,  $\overline{SHDN}=V_{IN}$ ,  $T_J=0$  to  $125^\circ C$ . Typical values refer to  $T_J=25^\circ C$ .

Symbol	Parameter	Test Conditions	APL5501/2/3			Unit	
			Min.	Typ.	Max.		
$V_{IN}$	Input Voltage		2.7	-	6	V	
$V_{OUT}$	Output Voltage	$V_{OUT}+1.0V < V_{CC} < 6.0V$ , $0mA < I_{OUT} < I_{MAX}$	$V_{OUT}-2\%$	$V_{OUT}$	$V_{OUT}+2\%$	V	
$I_{LIMIT}$	Circuit Current Limit	$V_{IN}=4.3V$	-	0.7	-	A	
$I_{SHORT}$	Short Current	$V_{OUT}=0V$	-	200	-	mA	
$I_{OUT}$	Load Current		500	-	-	mA	
REG <sub>LINE</sub>	Line Regulation	$V_{OUT}+0.5V < V_{CC} < 6.0V$ , $I_{OUT} = 1mA$	-	4	10	mV	
REG <sub>LOAD</sub>	Load Regulation	$V_{IN} = V_{OUT}+1.0V$ , $0mA < I_{OUT} < I_{MAX}$	-	1 0.1	6	mV %	
$V_{DROP}$	Dropout Voltage <sup>(Note 1)</sup>	$I_{OUT} = 500mA$	$1.3V \leq V_{OUT} < 1.5V$ $1.3V < -V_{OUT} < 1.5V$	-	1100	1300	mV
			$1.5V \leq V_{OUT} < 2V$	-	900	1050	
			$2V \leq V_{OUT} < 2.5V$	-	500	700	
			$2.5V \leq V_{OUT} < 3.4V$	-	280	380	
PSRR	Ripple Rejection	$F \leq 1kHz$ , $1V_{pp}$ at $V_{IN} = V_{OUT}+1.0V$ $C_{OUT}=10nf$	55	65	-	dB	
$I_Q$	Quiescent Current	No load	-	50	100	$\mu A$	
		$I_{OUT}=500mA$	-	370	450		
	Shutdown Supply Current <sup>(Note 2)</sup>	Shutdown = low $I_{OUT}=0$ , $V_{CC} = 6.0V$	-	0.01	1	$\mu A$	
	Noise <sup>(Note 2)</sup>	$100Hz < f < 100kHz$ , typical load, $C_{BP}=0.01\mu F$ , $C_{OUT} = 1\mu F$	-	50	-	$\mu V_{rms}$	
		$100Hz < f < 100kHz$ , typical load, $C_{BP}=0.1\mu F$ , $C_{OUT} = 1\mu F$	-	40	-		
	Shutdown Recovery Delay <sup>(Note 2)</sup>	$C_{BP}=0.01\mu F, C_{OUT}=1\mu F$ , no load	-	7	-	ms	
		$C_{BP}=0.1\mu F, C_{OUT}=1\mu F$ , no load	-	70	-		
OTS	Over Temperature Shutdown		-	150	-	$^\circ C$	
	Over Temperature Shutdown Hysteresis	Hysteresis	-	10	-	$^\circ C$	
TC	Output Voltage Temperature Coefficient		-	50	-	ppm/ $^\circ C$	
$C_{OUT}$	Output Capacitor		4.2	4.7	5.2	$\mu F$	
	ESR		0.02	0.1	1	Ohm	
	Shutdown Input Threshold <sup>(Note 2)</sup>	$V_{OUT}+1.0V < V_{IN} < 6.0V$	0.4	0.7	1.6	V	

## Electrical Characteristics (Cont.)

Unless otherwise noted these specifications apply over full temperature,  $V_{IN}=3.6V$ ,  $C_{IN}=1\mu F$ ,  $C_{OUT}=4.7\mu F$ ,  $\overline{SHDN}=V_{IN}$ ,  $T_J=0$  to  $125^\circ C$ . Typical values refer to  $T_J=25^\circ C$ .

Symbol	Parameter	Test Conditions	APL5501/2/3			Unit
			Min.	Typ.	Max.	
$I_{\overline{SHDN}}$	Shutdown input Bias Current (Note2)	$V_{\overline{SHDN}}=V_{IN}$	-	0.01	100	nA
	Input Reverse Leakage Current	$V_{OUT}-V_{IN}=0.1V$	-	0.1	0.5	$\mu A$
	Reverse Protection Threshold		-	11	50	mV

Note 1 : Dropout voltage definition :  $V_{IN}-V_{OUT}$  when  $V_{OUT}$  is 2% below the value of  $V_{OUT}$  for  $V_{IN} = V_{OUT} + 0.5V$

Note 2 : For 5-pin devices only.

Typical Operating Characteristics

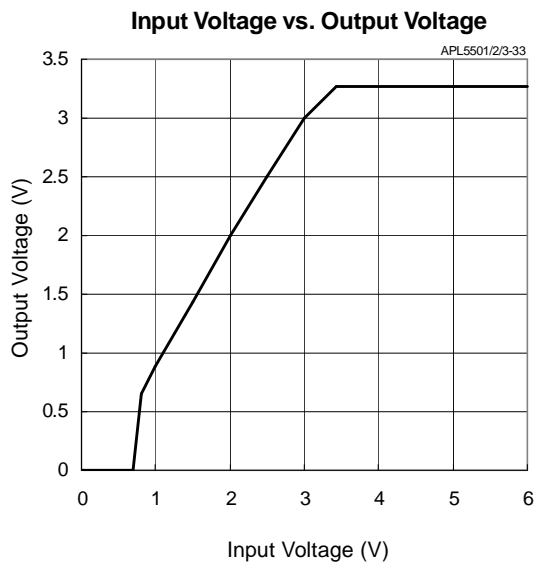
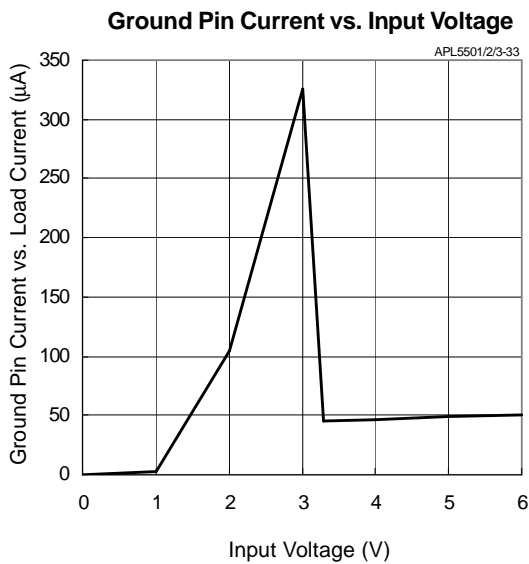
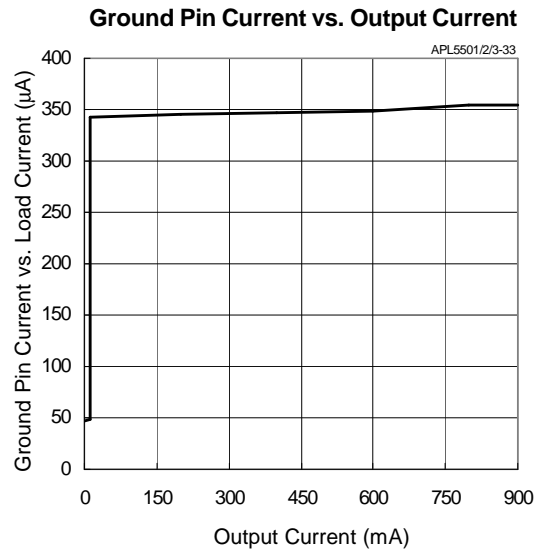
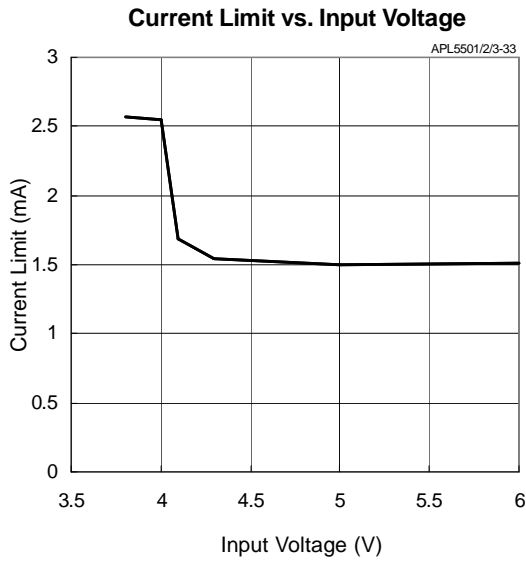

Typical Operating Characteristics (Cont.)

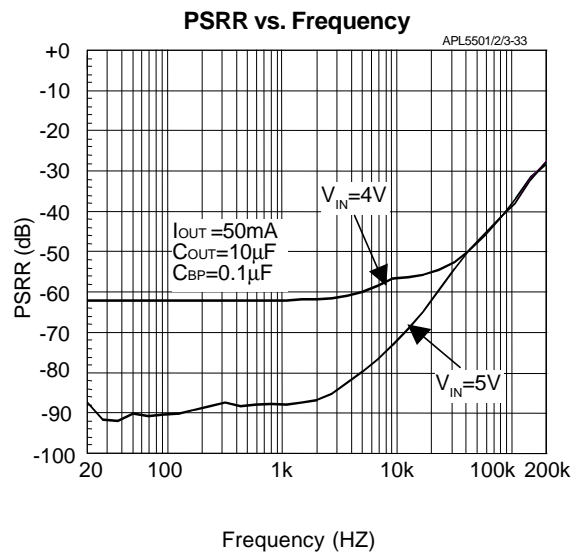
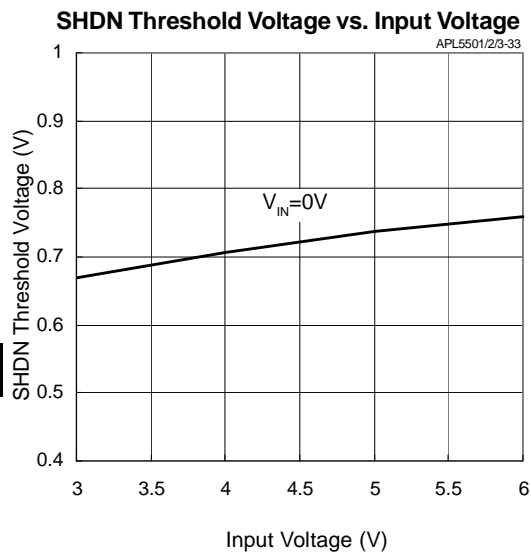
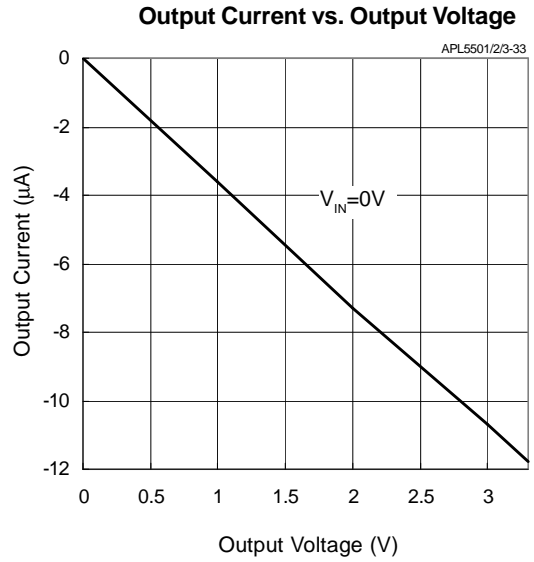
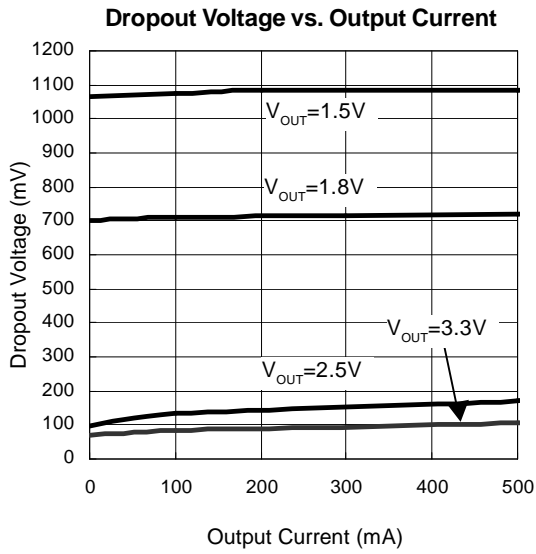

Typical Operating Characteristics (Cont.)

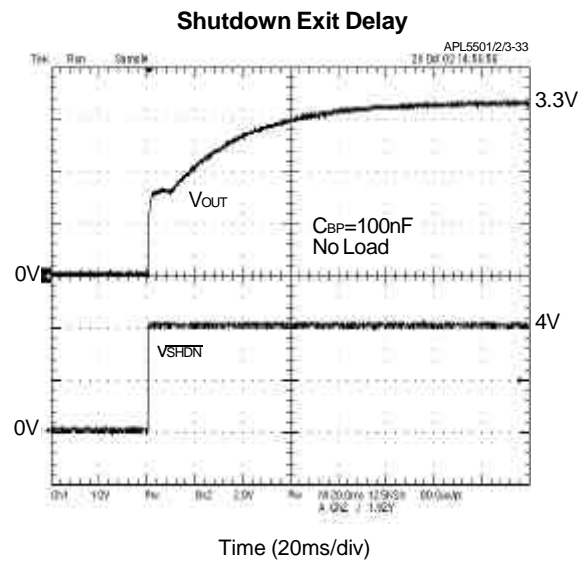
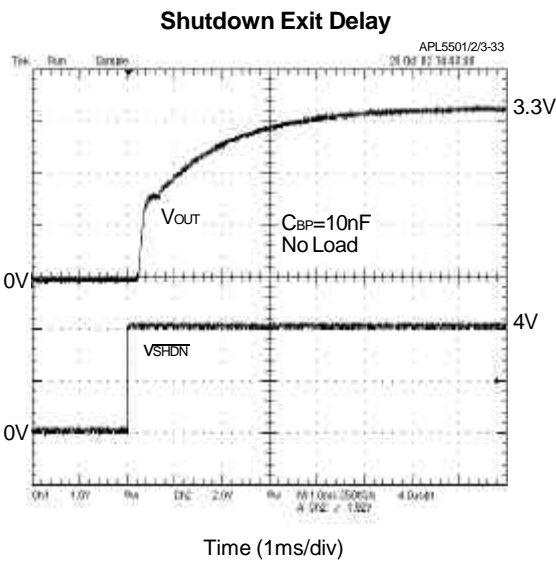
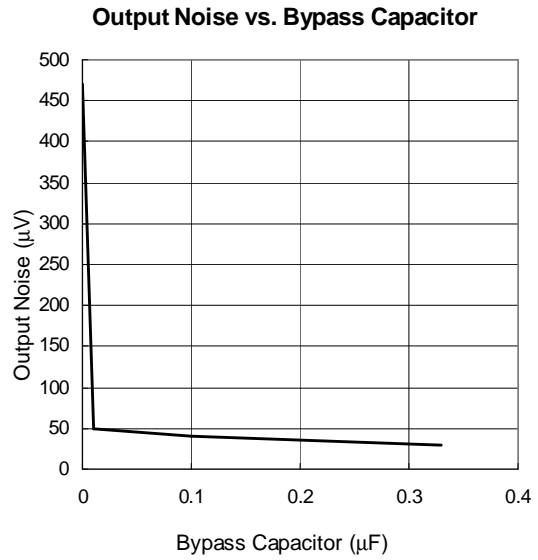
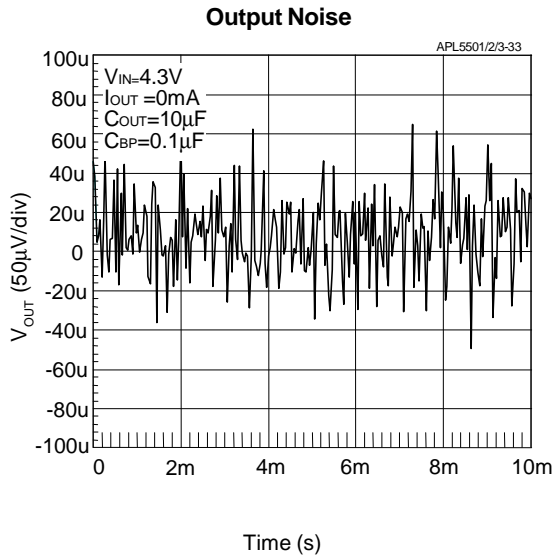



Typical Operating Characteristics (Cont.)

Entering Shutdown

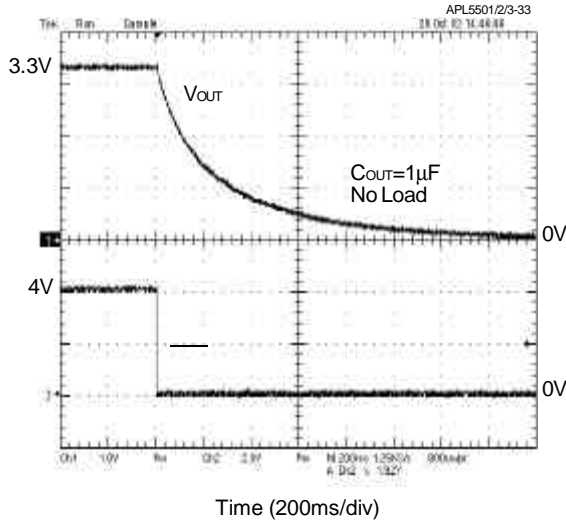

Region of Stable ESR vs. Load Current

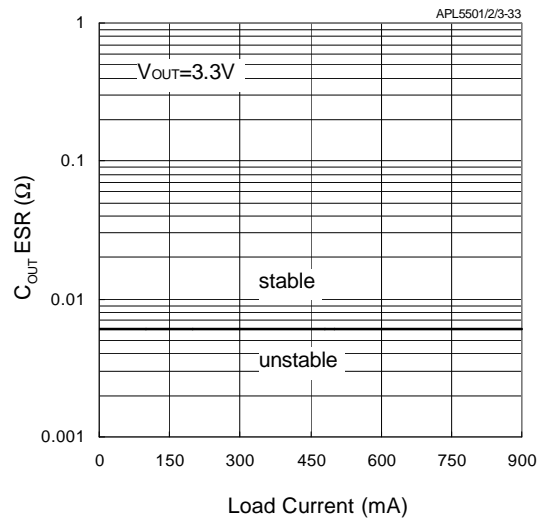

Output Voltage vs. Temperature

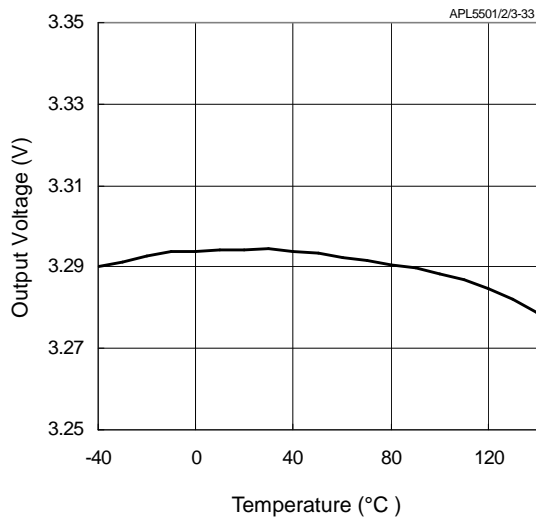

Line-Transient Response

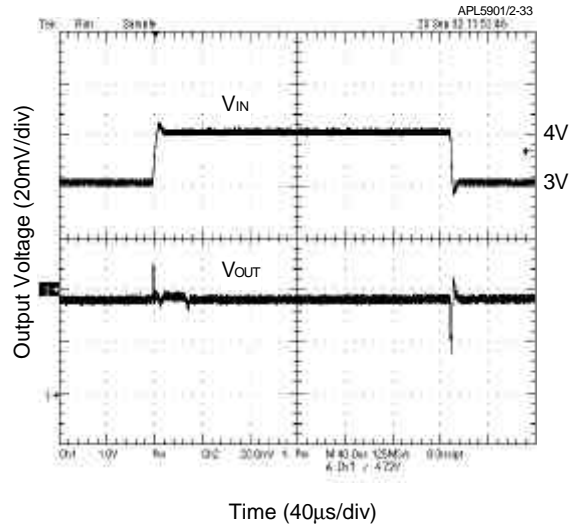

## Typical Operating Characteristics (Cont.)

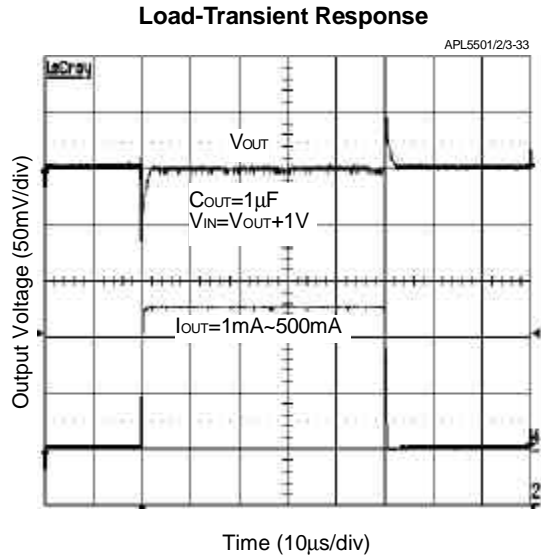

## Pin Description

PIN		I/O	FUNCTION
NO.	NAME		
1	VIN	I	Supply voltage input.
3	SHDN <sup>(Note 3)</sup>	I	Shutdown control pin, low = off , high = normal. Don't leave open.
2	GND		Ground pins of the circuitry, and all ground pins must be soldered to PCB with proper power dissipation.
4	BP <sup>(Note 3)</sup>	O	Bypass signal pin in fixed output type device
5	VOUT	O	Output pin of the regulator.

Note 3: These pins do not exist in 3-pin package.

## Typical Application Circuit

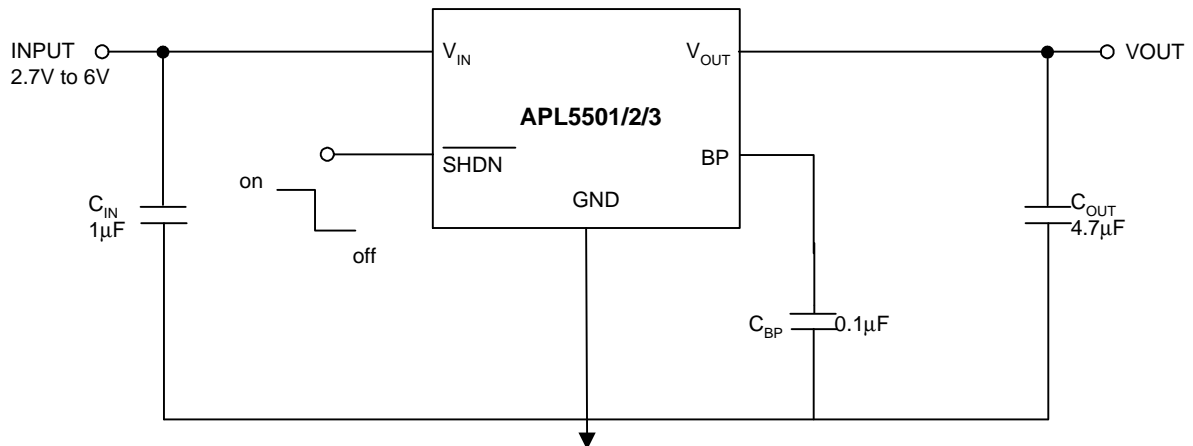

## Application Information

### Capacitor Selection and Regulator Stability

The APL5501/2/3 use at least a 1 $\mu$ F capacitor on the input, and this capacitor can be Aluminum, Tantalum, or Ceramic capacitor. The input capacitor with larger value and lower ESR provides better PSRR and line-transient response. The output capacitor also can use Aluminum, Tantalum, or Ceramic capacitor, and a minimum value of 1 $\mu$ F and ESR above 0.06 $\Omega$  is recommended. The curve of the stable region in typical characteristics shows the appropriate output capacitor ESR for different load current stable operation. A larger output capacitor can reduce noise and improve load-transient response, stability, and PSRR. Note that some ceramic dielectrics exhibit large capacitance and ESR variation with temperature. When using this capacitor, a minimum 10 $\mu$ F or more may be required to ensure the stability at low temperature operation. Use a bypass capacitor at BP pin for low output noise. Increasing the capacitance will slightly decrease the output noise but increase the start-up time.

### Load-Transient Consideration

The APL5501/2/3 load-transient response graphs in typical characteristics show the transient response. A step change in the load current from 0mA to 500mA at 1 $\mu$ s will cause a 100mV transient spike. Larger output capacitor and lower ESR can reduce transient spike.

### Input-Output (Dropout) Voltage

The minimum input-output voltage difference (dropout) determines the lowest usable supply voltage. In battery-powered systems, this will determine the useful end-of-life battery voltage. Because the APL5501/2/3 uses a p-channel MOSFET pass transistor, the dropout voltage is the function of drain-to-source on-resistance ( $R_{DS(ON)}$ ) multiplied by the load current.

### Reverse Current Protection

The APL5501/2/3 have an internal reverse protection, they do not need an external Schottky diode to connect the regulator input and output. If the output voltage is forced above the input voltage by more than 11mV, the IC will be shutdown and the ground pin current is below 0.1 $\mu$ A.

### Shutdown/Enable

The APL5501/2/3 has an active high enable function. Force EN high (>1.6V) enables the regulator, EN low (<0.4V) disables the regulator and enter the shutdown mode. In shutdown mode, the quiescent current can reduce below 1 $\mu$ A. The EN pin cannot be floating, a floating EN pin may cause an indeterminate state on the output. If it is no use, connect to VIN for normal operation.

### Current Limit

The APL5501/2/3 have current-limit protection. The output voltage will drop close to zero volt when load current reaches the limit, and then the load current will be limited at 150mA after output voltage is below 0.7V. When the load current back to the value where limiting started, the output voltage and current will return to normal value. When output is shorted to the ground, the APL5501/2/3 will keep short circuit current at 150mA.

### Thermal Protection

Thermal protection limits total power dissipation in the device. When the junction temperature exceeds  $T_J=+150^{\circ}\text{C}$ , the thermal sensor generates a logic signal to turn off the pass transistor and allows IC to cool. When the IC's junction temperature is down by 10 $^{\circ}\text{C}$ , the thermal sensor will turn the pass transistor on again, resulting in a pulsed output during continuous thermal protection. Thermal protection is designed to protect the APL5501/2/3 in the event of fault conditions. For continuous operation, do not exceed the absolute maximum junction temperature of  $T_J=+150^{\circ}\text{C}$ .

### Operating Region and Power Dissipation

The thermal resistance of the case to circuit board, and the rate of air flow all control the APL5501/2/3's maximum power dissipation. The power dissipation across the device is  $P_D = I_{OUT}(V_{IN} - V_{OUT})$  and the maximum power dissipation is:

$$P_{D_{MAX}} = (T_J - T_A) / (\theta_{JC} + \theta_{CA})$$

where  $T_J - T_A$  is the temperature difference between the junction and ambient air,  $\theta_{JC}$  is the thermal resistance of the package, and  $\theta_{CA}$  is the thermal resistance through

---

## Application Information (Cont.)

### Operating Region and Power Dissipation (Cont.)

the printed circuit board, copper traces, and other materials to the ambient air.

The GND pin of the APL5501/3 provides an electrical connection to ground and channeling heat away. If power dissipation is large, connect the GND pin to the ground using a large pad or ground plane, can improve the problem of over heat of IC.

Package Information

SOT-23-5

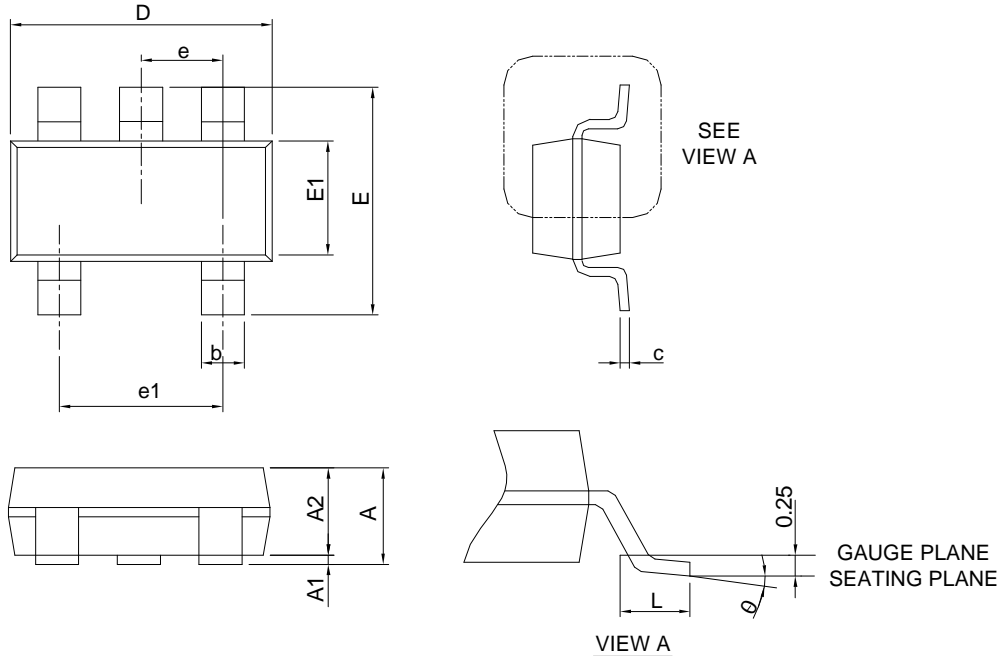

SYMBOL	SOT-23-5			
	MILLIMETERS		INCHES	
	MIN.	MAX.	MIN.	MAX.
A		1.45		0.057
A1	0.00	0.15	0.000	0.006
A2	0.90	1.30	0.035	0.051
b	0.30	0.50	0.012	0.020
c	0.08	0.22	0.003	0.009
D	2.70	3.10	0.106	0.122
E	2.60	3.00	0.102	0.118
E1	1.40	1.80	0.055	0.071
e	0.95 BSC		0.037 BSC	
e1	1.90 BSC		0.075 BSC	
L	0.30	0.60	0.012	0.024
θ	0°	8°	0°	8°

- Note : 1. Follow JEDEC TO-178 AA.  
 2. Dimension D and E1 do not include mold flash, protrusions or gate burrs. Mold flash, protrusion or gate burrs shall not exceed 10 mil per side.

Package Information

SOP-8

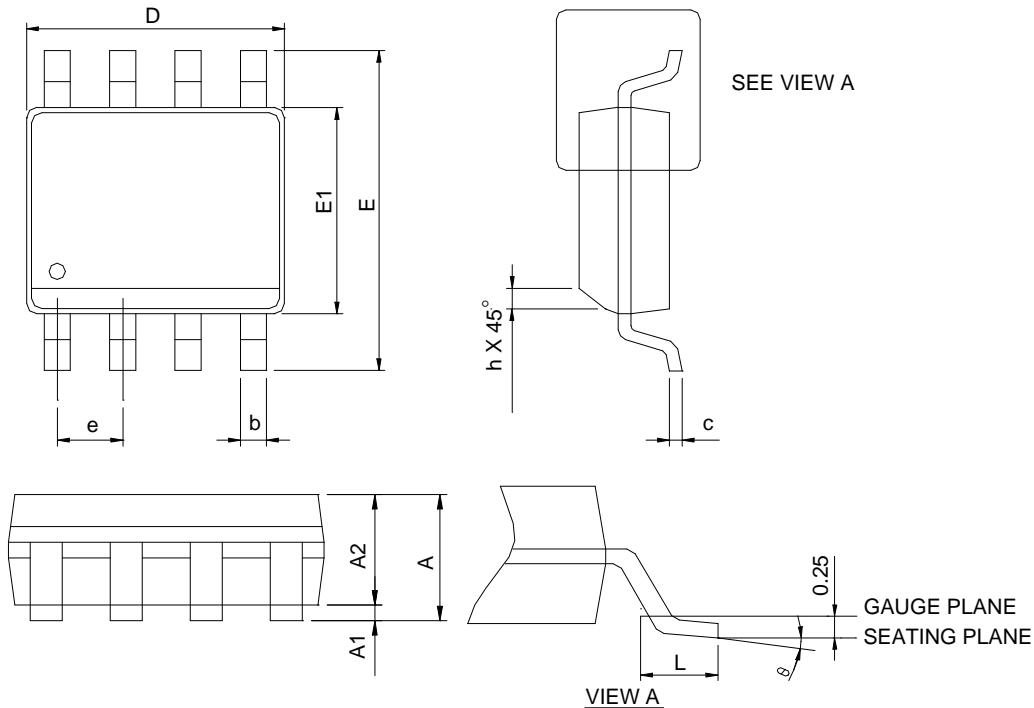

SYMBOL	SOP-8			
	MILLIMETERS		INCHES	
	MIN.	MAX.	MIN.	MAX.
A		1.75		0.069
A1	0.10	0.25	0.004	0.010
A2	1.25		0.049	
b	0.31	0.51	0.012	0.020
c	0.17	0.25	0.007	0.010
D	4.80	5.00	0.189	0.197
E	5.80	6.20	0.228	0.244
E1	3.80	4.00	0.150	0.157
e	1.27 BSC		0.050 BSC	
h	0.25	0.50	0.010	0.020
L	0.40	1.27	0.016	0.050
$\theta$	0°	8°	0°	8°

- Note: 1. Follow JEDEC MS-012 AA.  
 2. Dimension "D" does not include mold flash, protrusions or gate burrs. Mold flash, protrusion or gate burrs shall not exceed 6 mil per side.  
 3. Dimension "E" does not include inter-lead flash or protrusions. Inter-lead flash and protrusions shall not exceed 10 mil per side.

Package Information

SOT-223

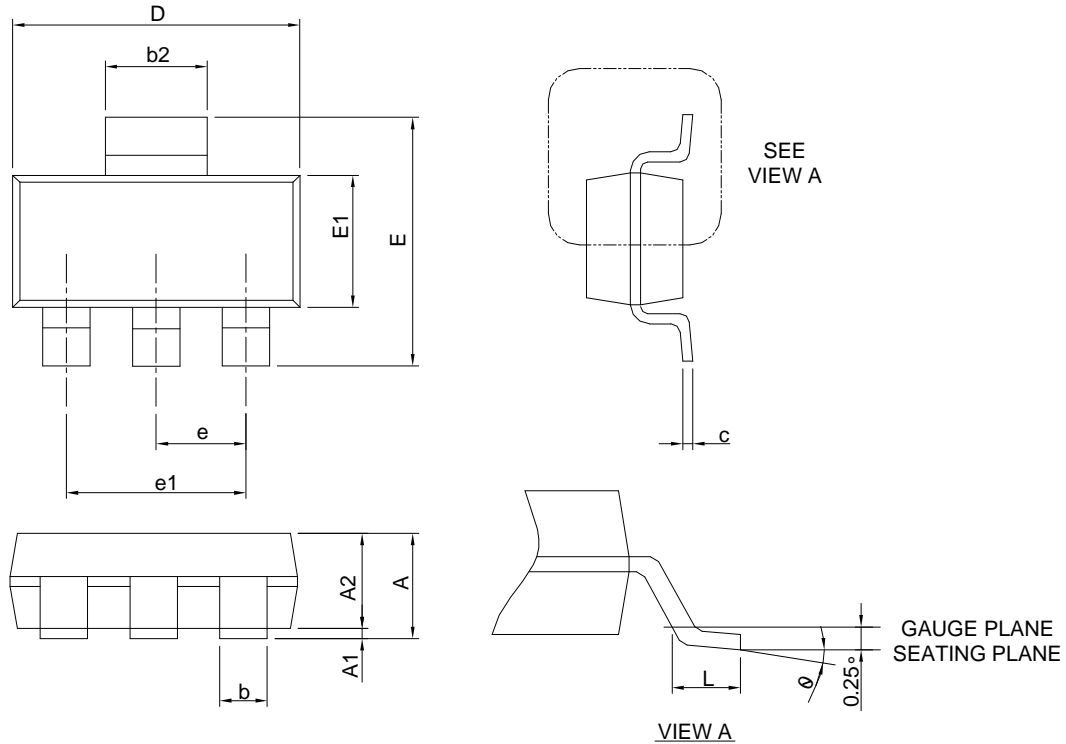

DIMENSIONS	SOT-223			
	MILLIMETERS		INCHES	
	MIN.	MAX.	MIN.	MAX.
A		1.80	0.071	
A1	0.02	0.10	0.001	0.004
A2	1.50	1.70	0.059	0.067
b	0.66	0.84	0.026	0.033
b2	2.90	3.10	0.114	0.122
c	0.23	0.33	0.009	0.013
D	6.30	6.70	0.248	0.264
E	6.70	7.30	0.264	0.287
E1	3.30	3.70	0.130	0.146
e	2.30 BSC		0.091 BSC	
e1	4.60 BSC		0.181 BSC	
L	0.75		0.030	
$\theta$	0°	10°	0°	10°

Note : 1. Follow from JEDEC TO-261 AA.  
 2. Dimension D and E1 are determined at the outermost extremes of the plastic exclusive of mold flash, tie bar burrs, gate burrs, and interlead flash, but including any mismatch between the top and bottom of the plastic body.

Package Information

SOT-89

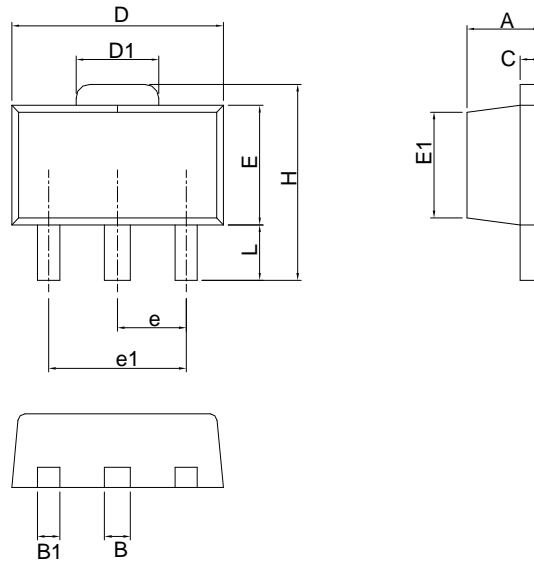

SYMBOL	SOT-89			
	MILLIMETERS		INCHES	
	MIN.	MAX.	MIN.	MAX.
A	1.40	1.60	0.055	0.063
B	0.44	0.56	0.017	0.022
B1	0.36	0.48	0.014	0.019
C	0.35	0.44	0.014	0.017
D	4.40	4.60	0.173	0.181
D1	1.62	1.83	0.064	0.072
E	2.29	2.60	0.090	0.102
E1	2.13	2.29	0.084	0.090
e	1.50 BSC		0.059 BSC	
e1	3.00 BSC		0.118 BSC	
H	3.94	4.25	0.155	0.167
L	0.89	1.20	0.035	0.047

Note : Follow JEDEC TO-243 AA.



Package Information

SOT-89-5

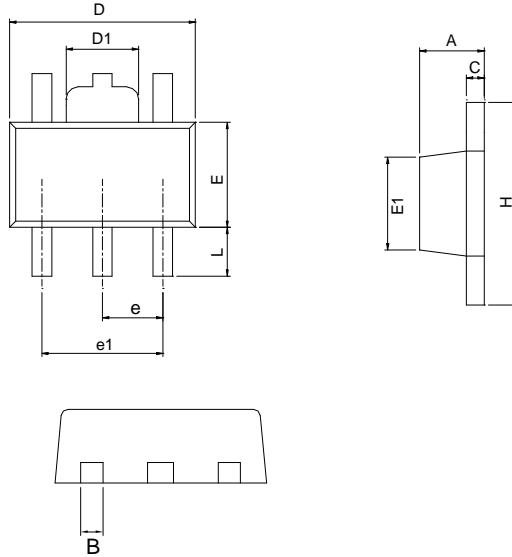

SYMBOL	SOT-89-5			
	MILLIMETERS		INCHES	
	MIN.	MAX.	MIN.	MAX.
A	1.40	1.60	0.055	0.063
B	0.36	0.56	0.014	0.022
C	0.35	0.44	0.014	0.017
D	4.40	4.60	0.173	0.181
D1	1.62	1.83	0.064	0.072
E	2.29	2.60	0.090	0.102
E1	2.13	2.29	0.084	0.090
e	1.50 BSC		0.059 BSC	
e1	3.00 BSC		0.118 BSC	
H	3.94	4.25	0.155	0.167
L	0.89	1.20	0.035	0.047

Package Information

TO-252-3

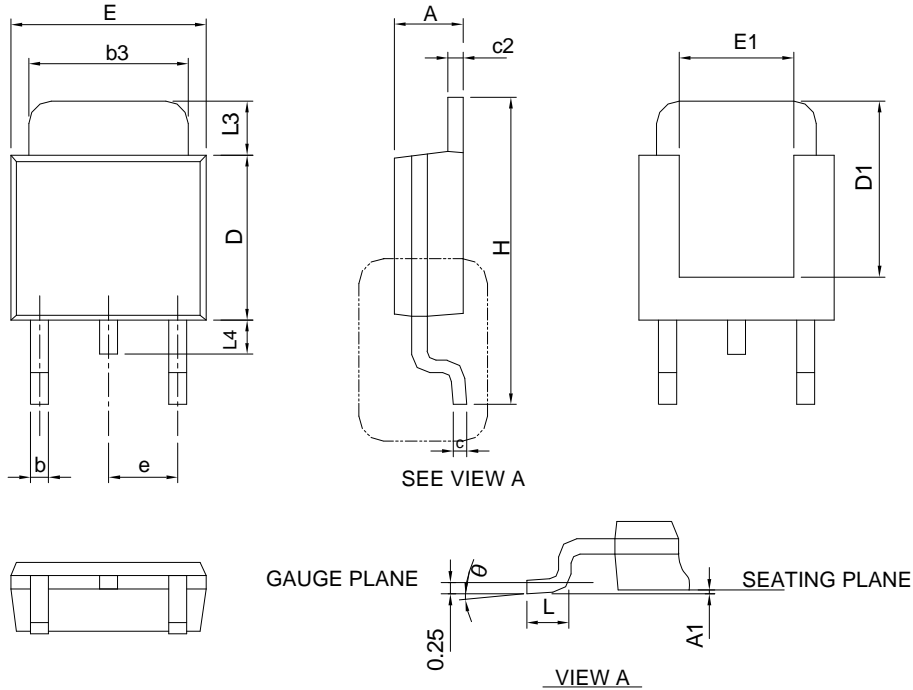

SYMBOL	TO-252-3			
	MILLIMETERS		INCHES	
	MIN.	MAX.	MIN.	MAX.
A	2.18	2.39	0.086	0.094
A1		0.13		0.005
b	0.50	0.89	0.020	0.035
b3	4.95	5.46	0.195	0.215
c	0.46	0.61	0.018	0.024
c2	0.46	0.89	0.018	0.035
D	5.33	6.22	0.210	0.245
D1	4.57	6.00	0.180	0.236
E	6.35	6.73	0.250	0.265
E1	3.81	6.00	0.150	0.236
e	2.29 BSC		0.090 BSC	
H	9.40	10.41	0.370	0.410
L	0.90	1.78	0.035	0.070
L3	0.89	2.03	0.035	0.080
L4		1.02		0.040
θ	0°	8°	0°	8°

Note : Follow JEDEC TO-252 .

Package Information

TO-252-5

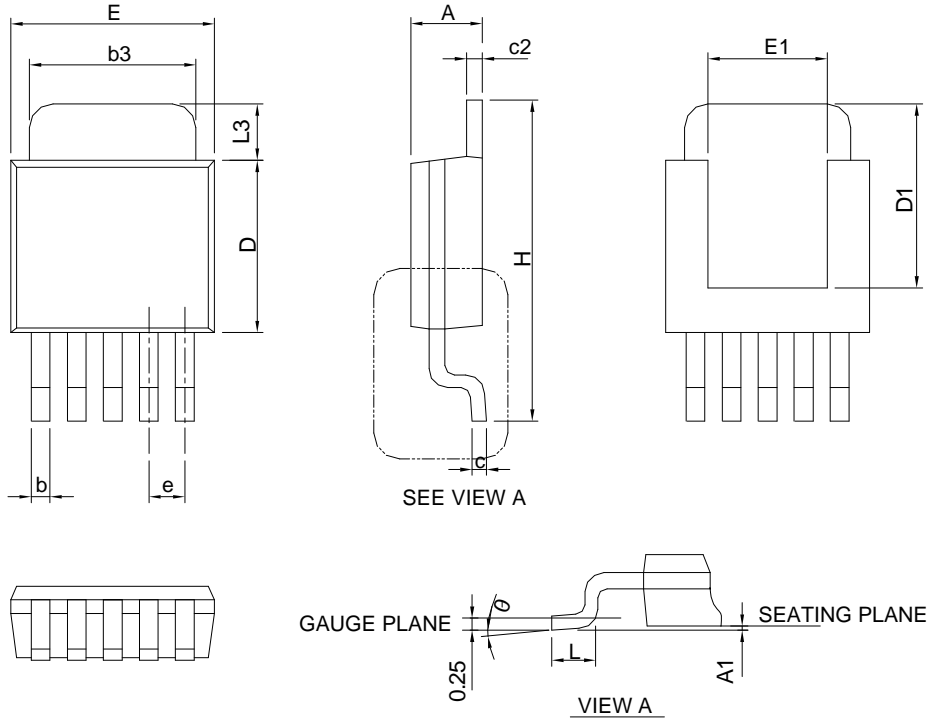

SYMBOL	TO-252-5			
	MILLIMETERS		INCHES	
	MIN.	MAX.	MIN.	MAX.
A	2.18	2.39	0.086	0.094
A1		0.13		0.005
b	0.50	0.89	0.020	0.035
b3	4.32	5.46	0.170	0.215
c	0.46	0.61	0.018	0.024
c2	0.46	0.89	0.018	0.035
D	5.33	6.22	0.210	0.245
D1	4.57	6.00	0.180	0.236
E	6.35	6.73	0.250	0.265
E1	3.81	6.00	0.150	0.236
e	1.27 BSC		0.050 BSC	
H	9.40	10.41	0.370	0.410
L	1.40	1.78	0.055	0.070
L3	0.89	2.03	0.035	0.080
$\theta$	0°	8°	0°	8°

### Carrier Tape & Reel Dimensions

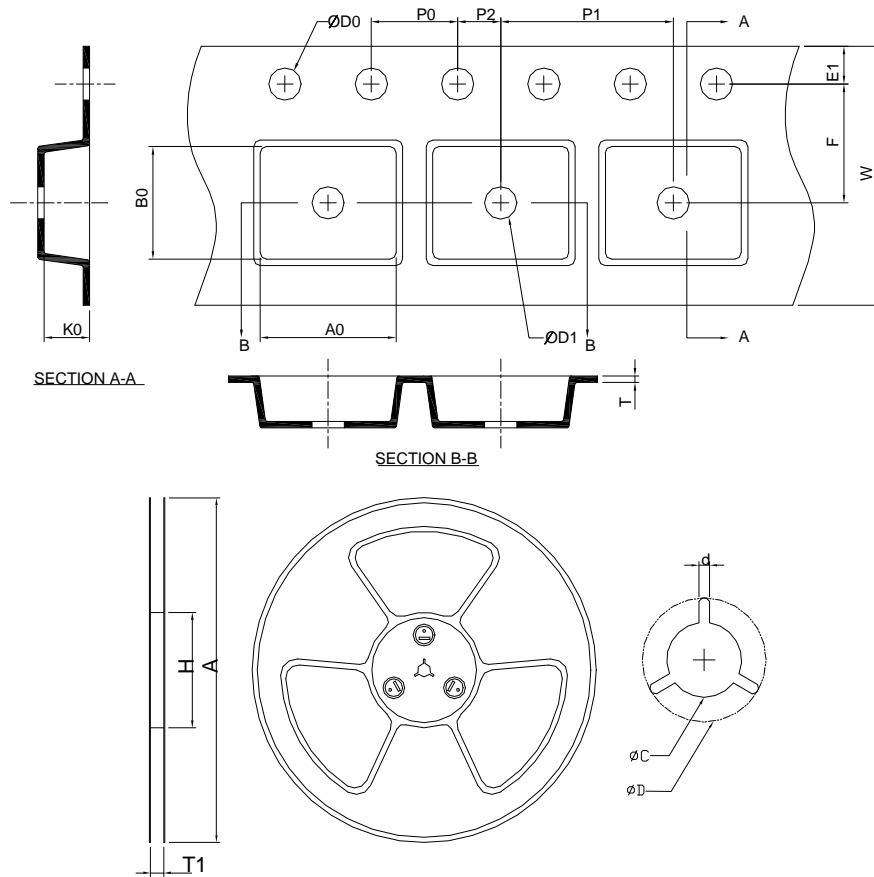

Application	A	H	T1	C	d	D	W	E1	F
SOT-23-5	178.0 ±2.00	50 MIN.	8.4+2.00 -0.00	13.0+0.50 -0.20	1.5 MIN.	20.2 MIN.	8.0 ±0.30	1.75 ±0.10	3.5 ±0.05
	P0	P1	P2	D0	D1	T	A0	B0	K0
	4.0 ±0.10	4.0 ±0.10	2.0 ±0.05	1.5+0.10 -0.00	1.0 MIN.	0.6+0.00 -0.40	3.20 ±0.20	3.10 ±0.20	1.50 ±0.20
Application	A	H	T1	C	d	D	W	E1	F
SOP-8	330.0 ±2.00	50 MIN.	12.4+2.00 -0.00	13.0+0.50 -0.20	1.5 MIN.	20.2 MIN.	12.0 ±0.30	1.75 ±0.10	5.5 ±0.05
	P0	P1	P2	D0	D1	T	A0	B0	K0
	4.0 ±0.10	8.0 ±0.10	2.0 ±0.05	1.5+0.10 -0.00	1.5 MIN.	0.6+0.00 -0.40	6.40 ±0.20	5.20 ±0.20	2.10 ±0.20
Application	A	H	T1	C	d	D	W	E1	F
SOT-223	320.0 ±2.00	50 MIN.	12.4+2.00 -0.00	13.0+0.50 -0.20	1.5 MIN.	20.2 MIN.	12.00 ±0.30	1.75 ±0.10	5.50 ±0.05
	P0	P1	P2	D0	D1	T	A0	B0	K0
	4.00 ±0.10	8.00 ±0.10	2.00 ±0.50	1.5+0.10 -0.00	1.5 MIN.	0.6+0.00 -0.40	6.90 ±0.20	7.50 ±0.20	2.10 ±0.20

(mm)

**Carrier Tape & Reel Dimensions (Cont.)**

Application	A	H	T1	C	d	D	W	E1	F
SOT-89	178.0 ±0.00	50 MIN.	12.4+2.00 -0.00	13.0+0.50 -0.20	1.5 MIN.	20.2 MIN.	12.0 ±0.30	1.75 ±0.10	5.50 ±0.05
	<b>P0</b>	<b>P1</b>	<b>P2</b>	<b>D0</b>	<b>D1</b>	<b>T</b>	<b>A0</b>	<b>B0</b>	<b>K0</b>
	4.0 ±0.10	8.0 ±0.10	2.0 ±0.05	1.5+0.10 -0.00	1.5 MIN.	0.6+0.00 -0.40	4.80 ±0.20	4.50 ±0.20	1.80 ±0.20
Application	A	H	T1	C	d	D	W	E1	F
SOT-89-5	178.0 ±0.00	50 MIN.	12.4+2.00 -0.00	13.0+0.50 -0.20	1.5 MIN.	20.2 MIN.	12.0 ±0.30	1.75 ±0.10	5.50 ±0.05
	<b>P0</b>	<b>P1</b>	<b>P2</b>	<b>D0</b>	<b>D1</b>	<b>T</b>	<b>A0</b>	<b>B0</b>	<b>K0</b>
	4.0 ±0.10	8.0 ±0.10	2.0 ±0.05	1.5+0.10 -0.00	1.5 MIN.	0.6+0.00 -0.40	4.80 ±0.20	4.50 ±0.20	1.80 ±0.20
Application	A	H	T1	C	d	D	W	E1	F
TO-252-3	330.0 ±0.00	50 MIN.	16.4+2.00 -0.00	13.0+0.50 -0.20	1.5 MIN.	20.2 MIN.	16.0 ±0.30	1.75 ±0.10	7.50 ±0.05
	<b>P0</b>	<b>P1</b>	<b>P2</b>	<b>D0</b>	<b>D1</b>	<b>T</b>	<b>A0</b>	<b>B0</b>	<b>K0</b>
	4.0 ±0.10	8.0 ±0.10	2.0 ±0.05	1.5+0.10 -0.00	1.5 MIN.	0.6+0.00 -0.40	6.80 ±0.20	10.40 ±0.20	2.50 ±0.20
Application	A	H	T1	C	d	D	W	E1	F
TO-252-5	330.0 ±0.00	50 MIN.	16.4+2.00 -0.00	13.0+0.50 -0.20	1.5 MIN.	20.2 MIN.	16.0 ±0.30	1.75 ±0.10	7.50 ±0.05
	<b>P0</b>	<b>P1</b>	<b>P2</b>	<b>D0</b>	<b>D1</b>	<b>T</b>	<b>A0</b>	<b>B0</b>	<b>K0</b>
	4.0 ±0.10	8.0 ±0.10	2.0 ±0.05	1.5+0.10 -0.00	1.5 MIN.	0.6+0.00 -0.40	6.80 ±0.20	10.40 ±0.20	2.50 ±0.20

(mm)

**Devices Per Unit**

Package Type	Unit	Quantity
SOT-23-5	Tape & Reel	3000
SOP-8	Tape & Reel	2500
SOT-223	Tape & Reel	2500
SOT-89	Tape & Reel	1000
SOT-89-5	Tape & Reel	1000
TO-252-3	Tape & Reel	2500
TO-252-5	Tape & Reel	2500

### Taping Direction Information

SOT-23-5

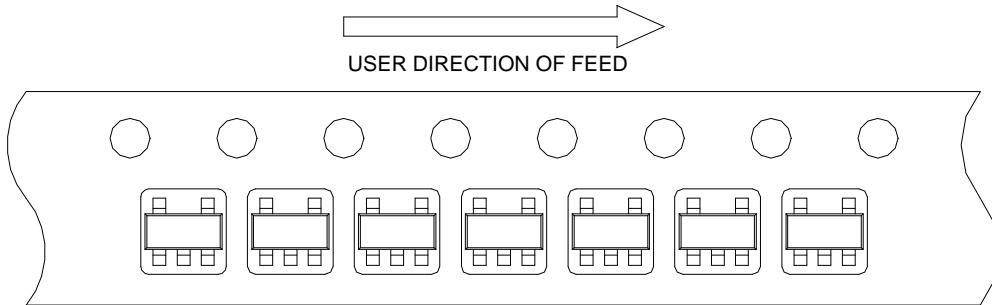

SOP-8

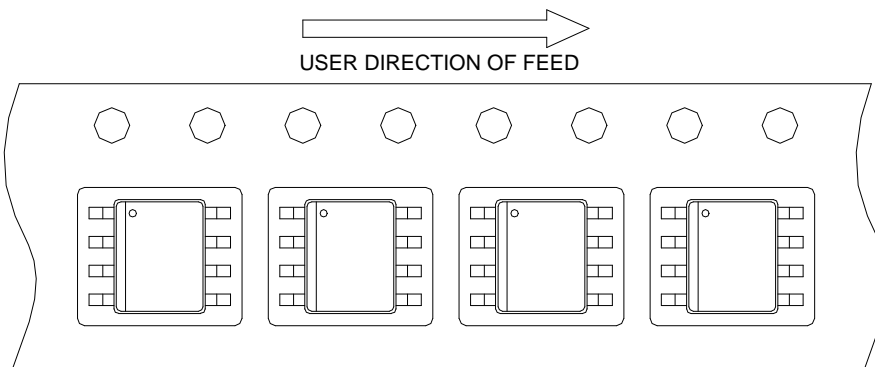

SOT-223

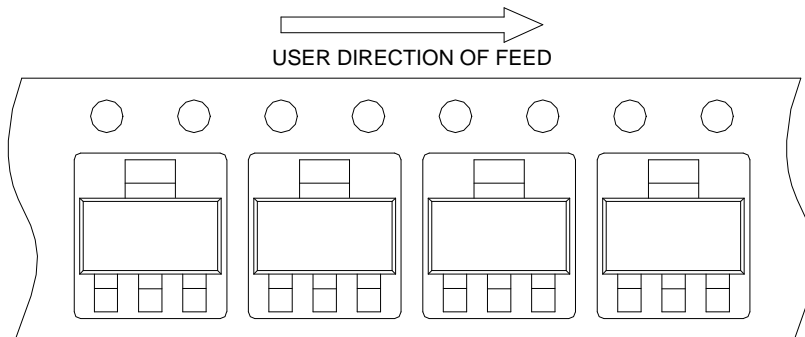

SOT-89

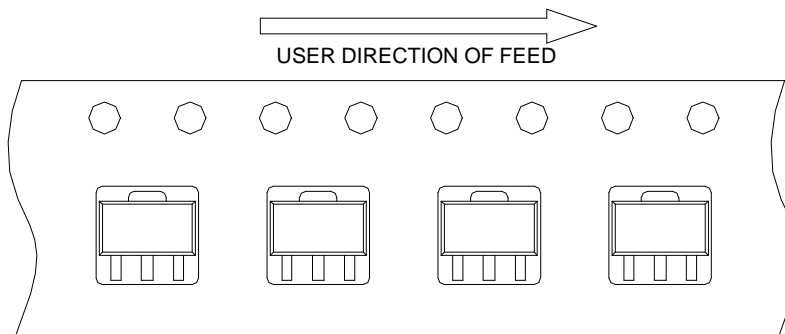

### Taping Direction Information

SOT-89-5

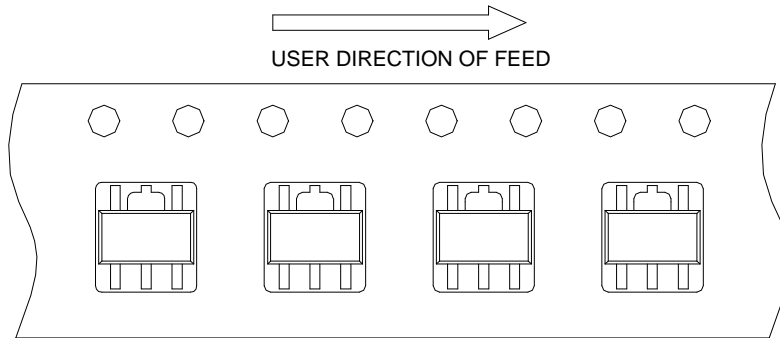

TO-252-3

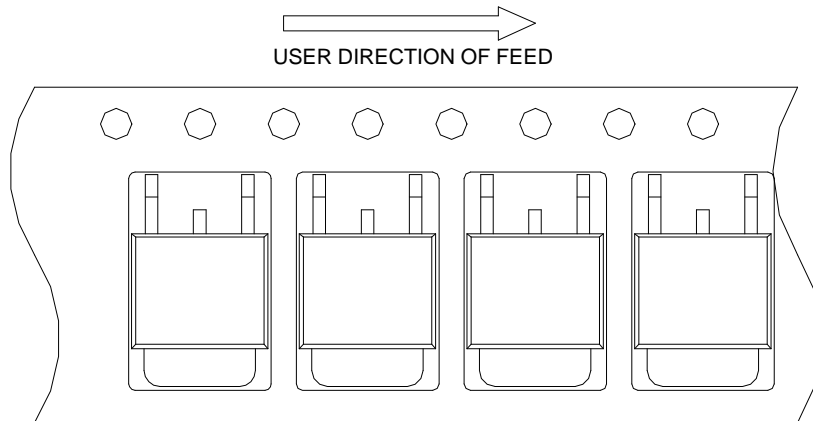

TO-252-5

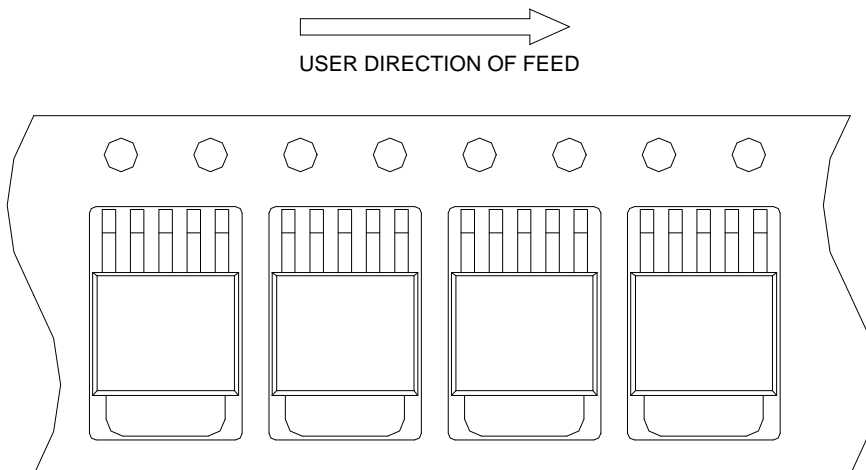

**Reflow Condition (IR/Convection or VPR Reflow)**

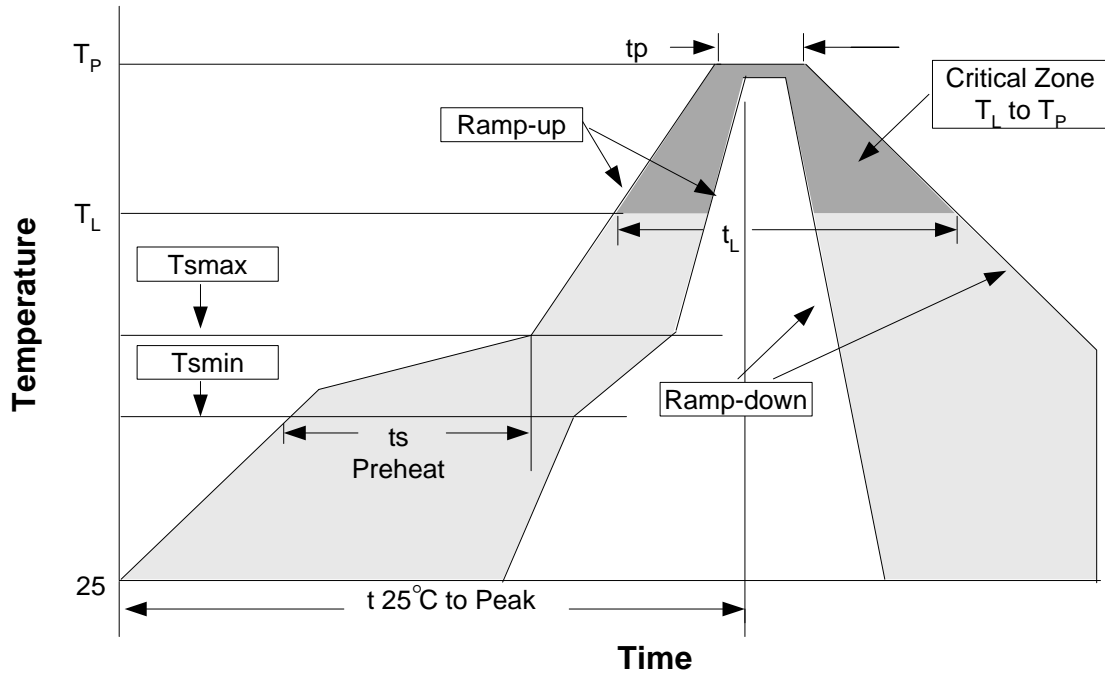

**Reliability Test Program**

Test item	Method	Description
SOLDERABILITY	MIL-STD-883D-2003	245°C, 5 sec
HOLT	MIL-STD-883D-1005.7	1000 Hrs Bias @ 125°C
PCT	JESD-22-B, A102	168 Hrs, 100%RH, 121°C
TST	MIL-STD-883D-1011.9	-65°C~150°C, 200 Cycles
ESD	MIL-STD-883D-3015.7	VHBM > 2KV, VMM > 200V
Latch-Up	JESD 78	10ms, 1 <sub>tr</sub> > 100mA

**Classification Reflow Profiles**

Profile Feature	Sn-Pb Eutectic Assembly	Pb-Free Assembly
Average ramp-up rate (T <sub>L</sub> to T <sub>P</sub> )	3°C/second max.	3°C/second max.
Preheat		
- Temperature Min (T <sub>min</sub> )	100°C	150°C
- Temperature Max (T <sub>max</sub> )	150°C	200°C
- Time (min to max) (t <sub>s</sub> )	60-120 seconds	60-180 seconds
Time maintained above:		
- Temperature (T <sub>L</sub> )	183°C	217°C
- Time (t <sub>L</sub> )	60-150 seconds	60-150 seconds
Peak/Classification Temperature (T <sub>P</sub> )	See table 1	See table 2
Time within 5°C of actual Peak Temperature (t <sub>p</sub> )	10-30 seconds	20-40 seconds
Ramp-down Rate	6°C/second max.	6°C/second max.
Time 25°C to Peak Temperature	6 minutes max.	8 minutes max.

Note: All temperatures refer to topside of the package. Measured on the body surface.



**Classification Reflow Profiles (Cont.)**

Table 1. SnPb Eutectic Process – Package Peak Reflow Temperatures

Package Thickness	Volume mm <sup>3</sup> <350	Volume mm <sup>3</sup> ≥350
<2.5 mm	240 +0/-5°C	225 +0/-5°C
≥2.5 mm	225 +0/-5°C	225 +0/-5°C

Table 2. Pb-free Process – Package Classification Reflow Temperatures

Package Thickness	Volume mm <sup>3</sup> <350	Volume mm <sup>3</sup> 350-2000	Volume mm <sup>3</sup> >2000
<1.6 mm	260 +0°C*	260 +0°C*	260 +0°C*
1.6 mm – 2.5 mm	260 +0°C*	250 +0°C*	245 +0°C*
≥2.5 mm	250 +0°C*	245 +0°C*	245 +0°C*

\*Tolerance: The device manufacturer/supplier **shall** assure process compatibility up to and including the stated classification temperature (this means Peak reflow temperature +0°C. For example 260°C+0°C) at the rated MSL level.

**Customer Service**

**Anpec Electronics Corp.**

Head Office :

No.6, Dusing 1st Road, SBIP,  
Hsin-Chu, Taiwan  
Tel : 886-3-5642000  
Fax : 886-3-5642050

Taipei Branch :

2F, No. 11, Lane 218, Sec 2 Jhongsing Rd.,  
Sindian City, Taipei County 23146, Taiwan  
Tel : 886-2-2910-3838  
Fax : 886-2-2917-3838