

SPECIFICATIONS:

MATERIAL:- \triangle
 INSULATOR: POLYAMIDE 9T, UL94V-0
 COLOR: BLACK
 CONTACT: PHOSPHOR BRONZE \triangle
 FINISH:-
 100% TIN PLATED

FOR COMPLETE SPECIFICATION, SEE COMPONENT SPECIFICATION IF AVAILABLE.

NOTES: ALL DIMENSIONS AND NOTES MARKED * ARE CRITICAL AND MUST BE CHECKED IN ACCORDANCE WITH QUALITY DOC. Q1-02A

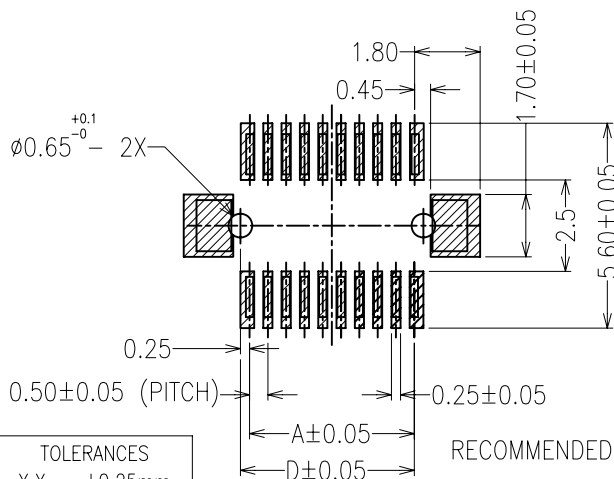

TOLERANCES
 X.X = ±0.25mm
 X.XX = ±0.13mm

RECOMMENDED PCB LAYOUT

M/H	TYPE	H	J	K				
2.0	01	05	1.62	2.6				
2.5	02		2.00					
3.0								
3.5	04	1.00	3.00	2.6				
4.0								
5.0								
6.0								
7.0								
8.0								
9.0								
10.0								
11.0								
11.5					05	1.50	3.50	3.6
4.5								
5.5								
6.5								
7.5								
8.5								
9.5								
10.5								
11.5								
12.0	06	7.00	10.00	2.54				
13.0								
14.0								
15.0								
16.0								
17.0								
12.5					07	7.50	10.50	2.54
13.5								
14.5								
15.5								
16.5								
17.5								

TOTAL NO. OF WAYS	A B C D					TOTAL NO. OF WAYS	A B C D			
	A	B	C	D	A		B	C	D	
10	2.0	5.0	4.0	2.5	62	15.0	18.0	17.0	15.5	
12	2.5	5.5	4.5	3.0	64	15.5	18.5	17.5	16.0	
14	3.0	6.0	5.0	3.5	66	16.0	19.0	18.0	16.5	
16	3.5	6.5	5.5	4.0	68	16.5	19.5	18.5	17.0	
18	4.0	7.0	6.0	4.5	70	17.0	20.0	19.0	17.5	
20	4.5	7.5	6.5	5.0	72	17.5	20.5	19.5	18.0	
22	5.0	8.0	7.0	5.5	74	18.0	21.0	20.0	18.5	
24	5.5	8.5	7.5	6.0	76	18.5	21.5	20.5	19.0	
26	6.0	9.0	8.0	6.5	78	19.0	22.0	21.0	19.5	
28	6.5	9.5	8.5	7.0	80	19.5	22.5	21.5	20.0	
30	7.0	10.0	9.0	7.5	82	20.0	23.0	22.0	20.5	
32	7.5	10.5	9.5	8.0	84	20.5	23.5	22.5	21.0	
34	8.0	11.0	10.0	8.5	86	21.0	24.0	23.0	21.5	
36	8.5	11.5	10.5	9.0	88	21.5	24.5	23.5	22.0	
38	9.0	12.0	11.0	9.5	90	22.0	25.0	24.0	22.5	
40	9.5	12.5	11.5	10.0	92	22.5	25.5	24.5	23.0	
42	10.0	13.0	12.0	10.5	94	23.0	26.0	25.0	23.5	
44	10.5	13.5	12.5	11.0	96	23.5	26.5	25.5	24.0	
46	11.0	14.0	13.0	11.5	98	24.0	27.0	26.0	24.5	
48	11.5	14.5	13.5	12.0	100	24.5	27.5	26.5	25.0	
50	12.0	15.0	14.0	12.5	110	27.0	30.0	29.0	27.5	
52	12.5	15.5	14.5	13.0	120	29.5	32.5	31.5	30.0	
54	13.0	16.0	15.0	13.5	130	32.0	35.0	34.0	32.5	
56	13.5	16.5	15.5	14.0	140	34.5	37.5	36.5	35.0	
58	14.0	17.0	16.0	14.5	150	37.0	40.0	39.0	37.5	
60	14.5	17.5	16.5	15.0	160	39.5	42.5	41.5	40.0	

Allan	4	03.10.07	A080
Allan	3	06.08.07	A066
Allan	2	15.03.07	A025
Allan	1	25.08.06	-

NAME	ISS.	DATE	C/NOTE
------	------	------	--------

APPROVED: *Alan*
 CHECKED: *Alan*

DRAWN: Allan

CUSTOMER REF.:

ASSEMBLY DRG:

ORDER CODE
M402VM-3- XXX - XX NR
 TOTAL NO. OF WAYS | TYPE
 (REFER TO TABLE)



HARWIN USA
 TEL: 603 893 5376
 FAX: 603 893 5396
 mis@harwin.com

HARWIN Europe (UK)
 TEL: 023 9231 4545
 FAX: 023 9231 4590
 mis@harwin.co.uk

HARWIN Asia
 TEL: +65 6 779 4909
 FAX: +65 6 779 3868
 mis@harwin.com.sg

THIS DRAWING AND ANY INFORMATION OR DESCRIPTIVE MATTER SET OUT HEREON ARE CONFIDENTIAL AND COPYRIGHT PROPERTY OF THE HARWIN GROUP AND MUST NOT BE DISCLOSED, LOANED, COPIED OR USED FOR MANUFACTURING, TENDERING OR FOR ANY OTHER PURPOSE WITHOUT THEIR WRITTEN PERMISSION.

TOLERANCES
 X. = ±1mm
 X.X = ±0.25mm
 X.XX = ±0.10mm
 X.XXX = ±0.01mm
 ANGLES = ±5°
 UNLESS STATED

MATERIAL: SEE NOTES
 FINISH: SEE NOTES
 S/AREA: mm²

TITLE:
M402V SERIES 0.5 BOARD TO BOARD SMT V/T TYPE MALE
 DRAWING NUMBER:
M402VM-3- XXX - XX NR
 SHT 1 OF 3

3

TOTAL NO. OF WAYS \ TYPE	01	02	04	05	06	07
10	●	●	●	●	○	●
12	●	●	●	●	○	○
14	●	●	●	●	○	●
16	●	●	●	●	○	●
18	●	●	●	●	○	○
20	●	●	●	●	○	○
22	●	●	●	○	○	○
24	●	●	●	●	●	○
26	●	●	●	○	○	○
28	●	●	●	●	○	○
30	●	●	●	●	●	○
32	●	●	●	●	○	○
34	●	○	●	●	○	○
36	○	●	●	●	○	○
38	●	○	●	●	●	○
40	●	●	●	●	●	○
42	○	○	○	○	○	○

TOTAL NO. OF WAYS \ TYPE	01	02	04	05	06	07
44	●	●	●	●	○	○
46	○	○	●	○	○	○
48	○	○	○	○	●	○
50	●	●	●	●	○	○
52	○	○	○	●	○	○
54	○	○	●	○	○	○
56	○	○	○	○	○	○
58	○	○	○	○	○	○
60	●	●	●	●	●	○
62	○	○	○	○	○	○
64	○	○	○	○	○	○
66	○	○	○	○	○	○
68	○	○	●	●	○	○
70	○	○	●	○	○	○
72	○	○	○	○	○	○
74	○	○	○	○	○	○
76	○	○	○	○	○	○

TOTAL NO. OF WAYS \ TYPE	01	02	04	05	06	07
78	○	○	○	○	○	○
80	●	●	●	●	○	○
82	○	○	○	○	○	○
84	○	○	○	○	○	○
86	○	○	○	○	○	○
88	○	○	○	○	○	○
90	○	○	○	○	●	○
92	○	○	○	○	○	○
94	○	○	○	○	○	○
96	○	○	○	○	○	○
98	○	○	○	○	○	○
100	●	●	●	●	●	○
110	○	○	○	○	○	○
120	○	●	○	○	○	○
130	○	○	○	○	○	○
140	○	○	○	○	○	○
150	○	○	○	○	○	○
160	○	○	○	○	○	○

● - MOULDS AVAILABLE
 ○ - MOULDS UPON REQUEST.
 PLEASE REFER TECHNICAL SALES

Allan	4	03.10.07	A080
Allan	3	06.08.07	A066
Allan	2	15.03.07	A025
Allan	1	25.08.06	-

NAME	ISS.	DATE	C/NOTE
------	------	------	--------

APPROVED: _____

CHECKED: *Ben*

ORDER CODE
M402VM-3- XXX - XX NR
 TOTAL NO. OF WAYS $\left\{ \begin{array}{l} \text{TYPE} \\ \text{(REFER TO TABLE)} \end{array} \right.$

DRAWN: Allan

CUSTOMER REF.:

ASSEMBLY DRG:

HARWIN

HARWIN USA
 TEL: 603 893 5376
 FAX: 603 893 5396
 mis@harwin.com

HARWIN Europe (UK)
 TEL: 023 9231 4545
 FAX: 023 9231 4590
 mis@harwin.co.uk

HARWIN Asia
 TEL: +65 6 779 4909
 FAX: +65 6 779 3868
 mis@harwin.com.sg

THIS DRAWING AND ANY INFORMATION OR DESCRIPTIVE MATTER SET OUT HEREON ARE CONFIDENTIAL AND COPYRIGHT PROPERTY OF THE HARWIN GROUP AND MUST NOT BE DISCLOSED, LOANED, COPIED OR USED FOR MANUFACTURING, TENDERING OR FOR ANY OTHER PURPOSE WITHOUT THEIR WRITTEN PERMISSION.

TOLERANCES
 X. = ±1mm
 X.X = ±0.25mm
 X.XX = ±0.10mm
 X.XXX = ±0.01mm
 ANGLES = ±5°
 UNLESS STATED

MATERIAL: SEE NOTES
 FINISH: SEE NOTES
 S/AREA: mm²

TITLE:
M402V SERIES 0.5 BOARD TO BOARD SMT V/T TYPE MALE
 DRAWING NUMBER:
M402VM-3- XXX - XX NR
 SHT 2 OF 3

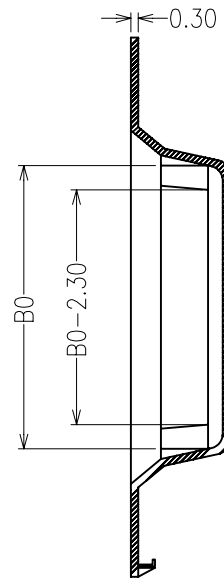
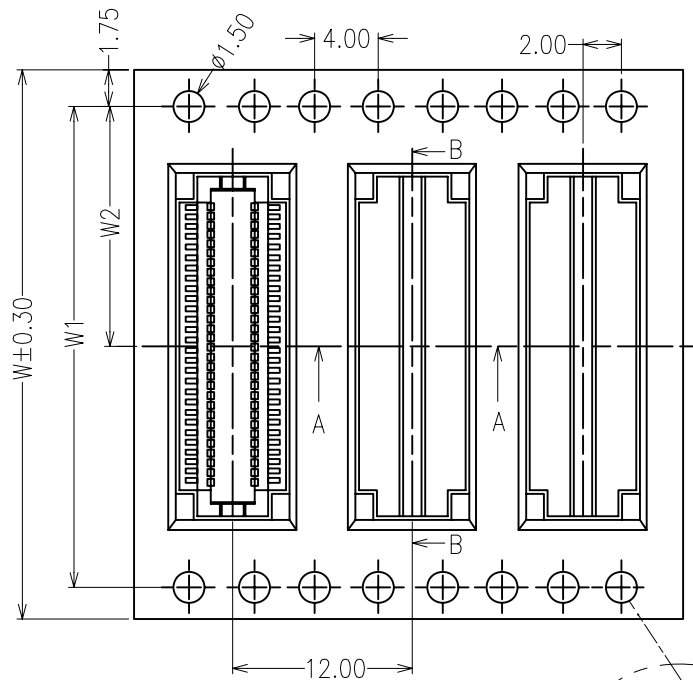

SECTION B-B

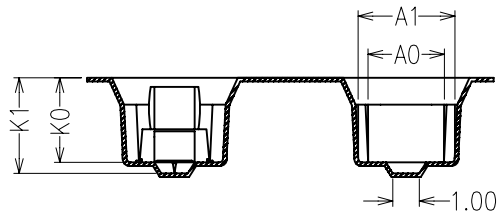

SECTION A-A

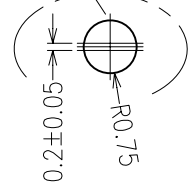

CKT	10	14	18	22	26	30	34	38	42	46
PIN	10 12	14 16	18 20	22 24	26 28	30 32	34 36	38 40	42 44	46 48
W	016	016	016	016	024	024	024	024	024	024
B0	5.75	6.75	7.75	8.75	9.75	10.75	11.75	12.75	13.75	14.75

CKT	50	54	58	62	66	70	74	78	82	86
PIN	50 52	54 56	58 60	62 64	66 68	70 72	74 76	78 80	82 84	86 88
W	024	032	032	032	032	032	044	044	044	044
B0	15.75	16.75	17.75	18.75	19.75	20.75	21.75	22.75	23.75	24.75

CKT	90	94	98	B0	C0	D0	E0	F0	G0
PIN	90 92	94 96	98 A0	B0	C0	D0	E0	F0	G0
W	044	044	044	044	056	056	056	056	056
B0	25.75	26.75	27.75	30.25	32.75	35.25	37.75	40.25	42.75

ITEM	A0	A1	K0	K1	PITCH	PCS/REEL
DIM	4.30	6.00	3.30	3.90	12.00	1500

W	W1	W2
16		7.50
24		11.50
32	28.40	14.20
44	40.40	20.20
56	52.40	26.20

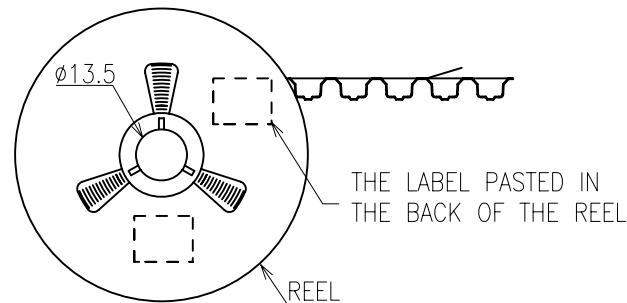
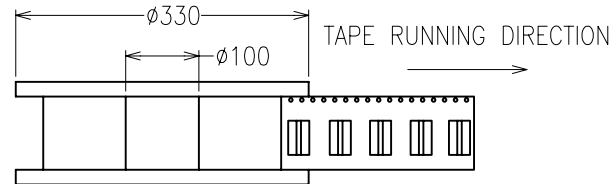

- NOTES:
1. 10 SPROCKET HOLE PITCH CUMULTAIVE TOLERANCE ± 0.20
 2. CARRIER CAMBER IS WITHIN 1MM IN 250MM
 3. MATERIAL: BALCK CONDUCTIVE POLYSTYRENE ALLOY

Allan	4	03.10.07	A080
Allan	3	06.08.07	A066
Htut	2	14.03.07	A025

NAME	ISS.	DATE	C/NOTE
------	------	------	--------

APPROVED: _____

CHECKED: *Htut*

DRAWN: Htut htut

CUSTOMER REF.:

ASSEMBLY DRG:

HARWIN

HARWIN USA
TEL: 603 893 5376
FAX: 603 893 5396
mis@harwin.com

HARWIN Europe (UK)
TEL: 023 9231 4545
FAX: 023 9231 4590
mis@harwin.co.uk

HARWIN Asia
TEL: +65 6 779 4909
FAX: +65 6 779 3868
mis@harwin.com.sg

THIS DRAWING AND ANY INFORMATION OR DESCRIPTIVE MATTER SET OUT HEREON ARE CONFIDENTIAL AND COPYRIGHT PROPERTY OF THE HARWIN GROUP AND MUST NOT BE DISCLOSED, LOANED, COPIED OR USED FOR MANUFACTURING, TENDERING OR FOR ANY OTHER PURPOSE WITHOUT THEIR WRITTEN PERMISSION.

TOLERANCES
X. = ± 1 mm
X.X = ± 0.20 mm
X.XX = ± 0.10 mm
X.XXX = ± 0.01 mm
ANGLES = $\pm 0^{\circ}30'$
UNLESS STATED

MATERIAL: SEE NOTES
FINISH: SEE NOTES
S/AREA: mm²

TITLE:
M402V SERIES 0.5 BOARD TO BOARD SMT V/T TYPE MALE
DRAWING NUMBER:
M402VM-3- XXX - XX NR
SHT 3 OF 3