

# COMPACT FLASH CARD CONNECTORS

## 560H SERIES (CFA COMPATIBLE)

### ■ FEATURES

- The connectors conform to the Compact Flash Association (CFA) specifications.
- The terminal of the plug is a 0.635 mm pitch, one-row, SMT type.
- Raised mounting type connectors (standoff), which allow mounting components under a connector, are also available.
- The ejector mechanism makes insertion and ejection of a card easier is available.
- There are two types of sockets for CFA cards: a straddle mount type and single-sided mounting type.

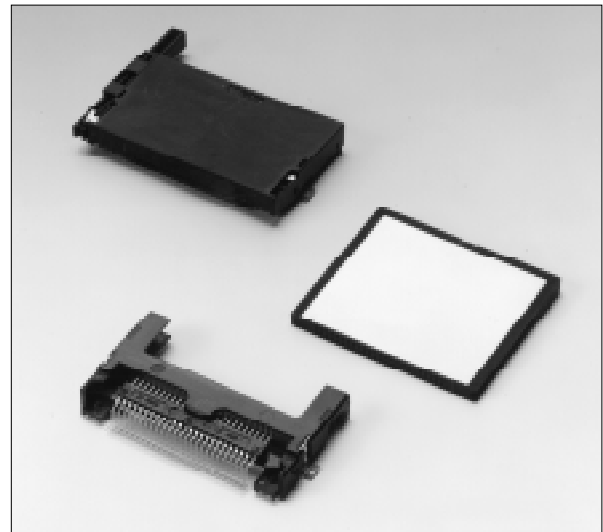

### ■ SPECIFICATIONS

Item	Specification
Operating temperature range	-55° to +85 ° C
Rated current	0.5A DC
Rated voltage	250V AC
Contact resistance	80mΩ max (DC 20mV, 10mA)
Insulation resistance	1000MΩ min., 500V DC,
Dielectric withstand voltage	500V DC

### ■ PIN CONNECTOR (PLUG) CONTACT LENGTH

Contact Type	Pin no.	Contact length
Power, ground pins	1, 13, 38, 50	4.98 mm (0.196 in.)
Card dection pins	25, 26	3.48 mm (0.137 in.)
Other signal pins	Other	4.24 mm (0.167 in.)

### ■ MATERIALS

Item	Material
Insulating material	Main body: PPS resin UL94V-0 Guide: PBT UL94V-0 Button: ABS UL94V-0
Conductor	Copper alloy
Plating	Contact: gold Terminal: palladium

# 560H Series (Compact Flash Connector)

## RIGHT ANGLE PLUG, SMT TYPE (WITH NO EJECTOR)

### ■ DIMENSIONS

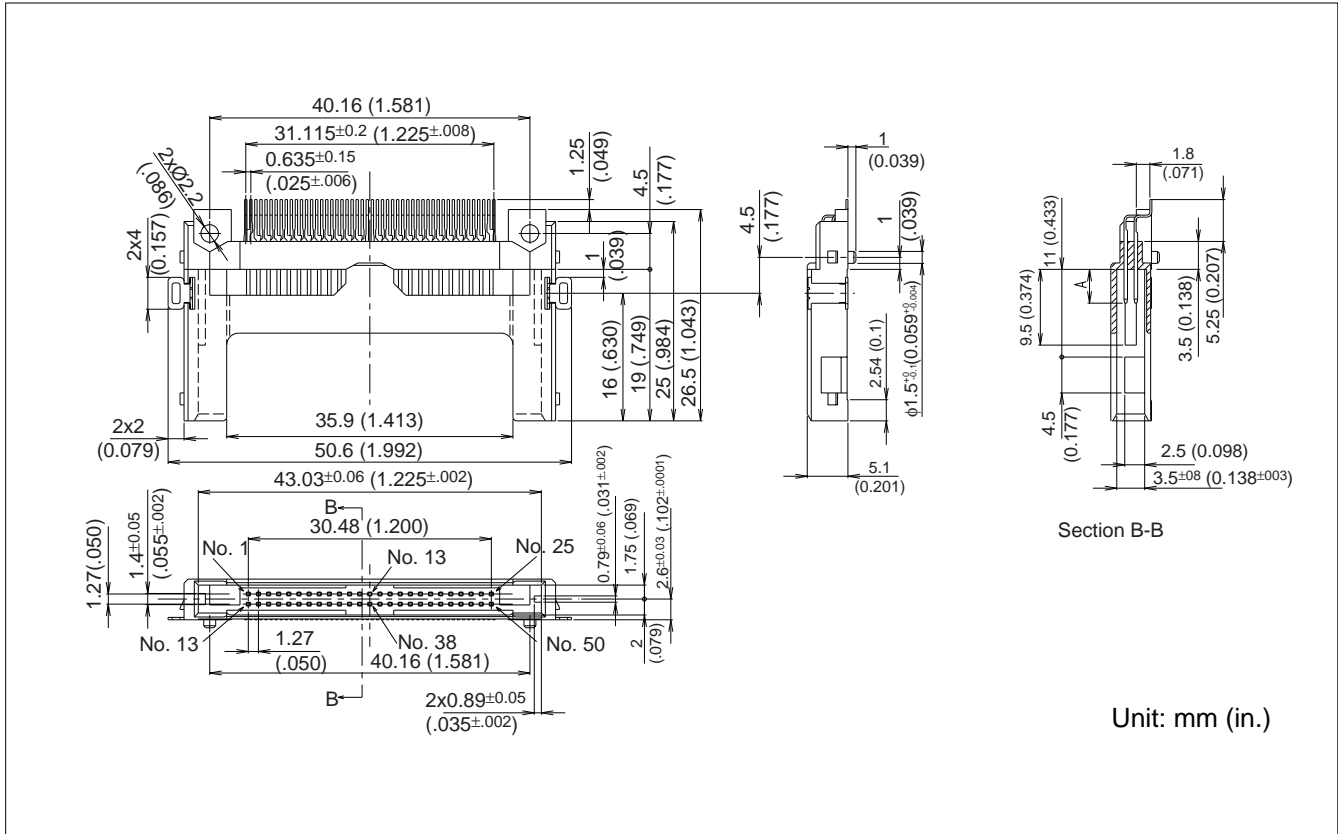

### ■ PC BOARD MOUNTING PATTERN (MOUNTING SIDE)

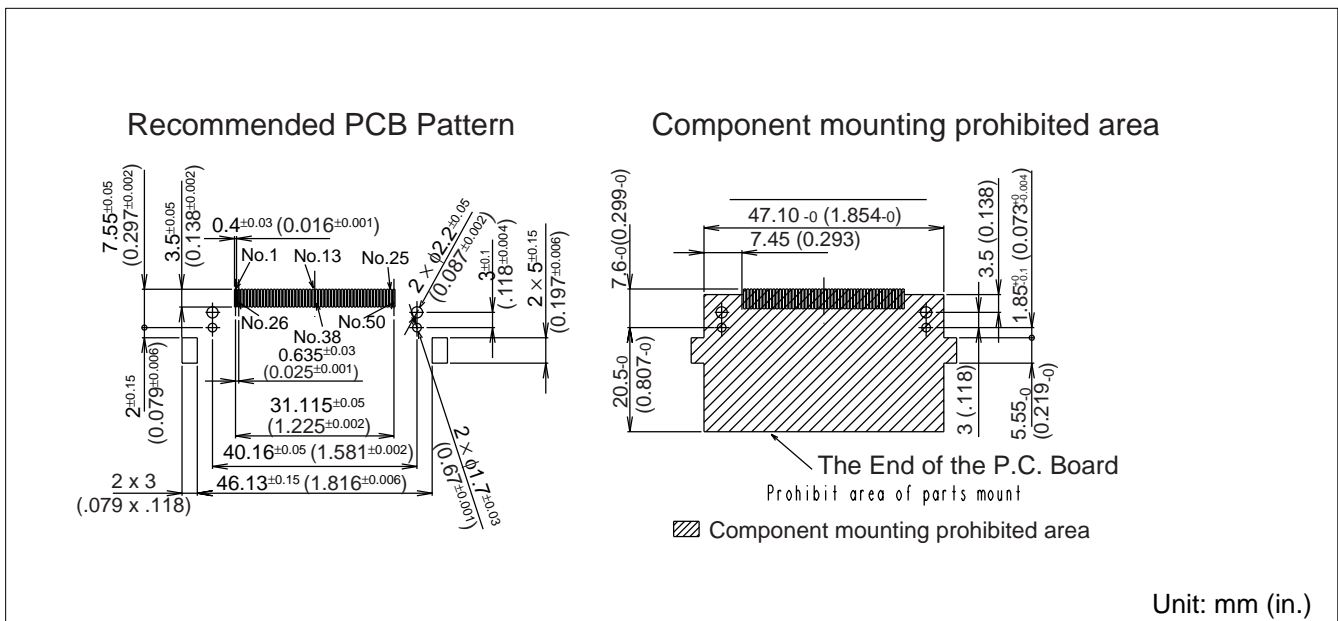

### ■ ORDERING PART NUMBER

FCN-568H050-G/A1

For above connector with ejector mechanism  
see page 3.

# 560H Series (Compact Flash Connector)

## RIGHT ANGLE PLUG, SMT TYPE (WITH EJECTOR)

### ■ DIMENSIONS

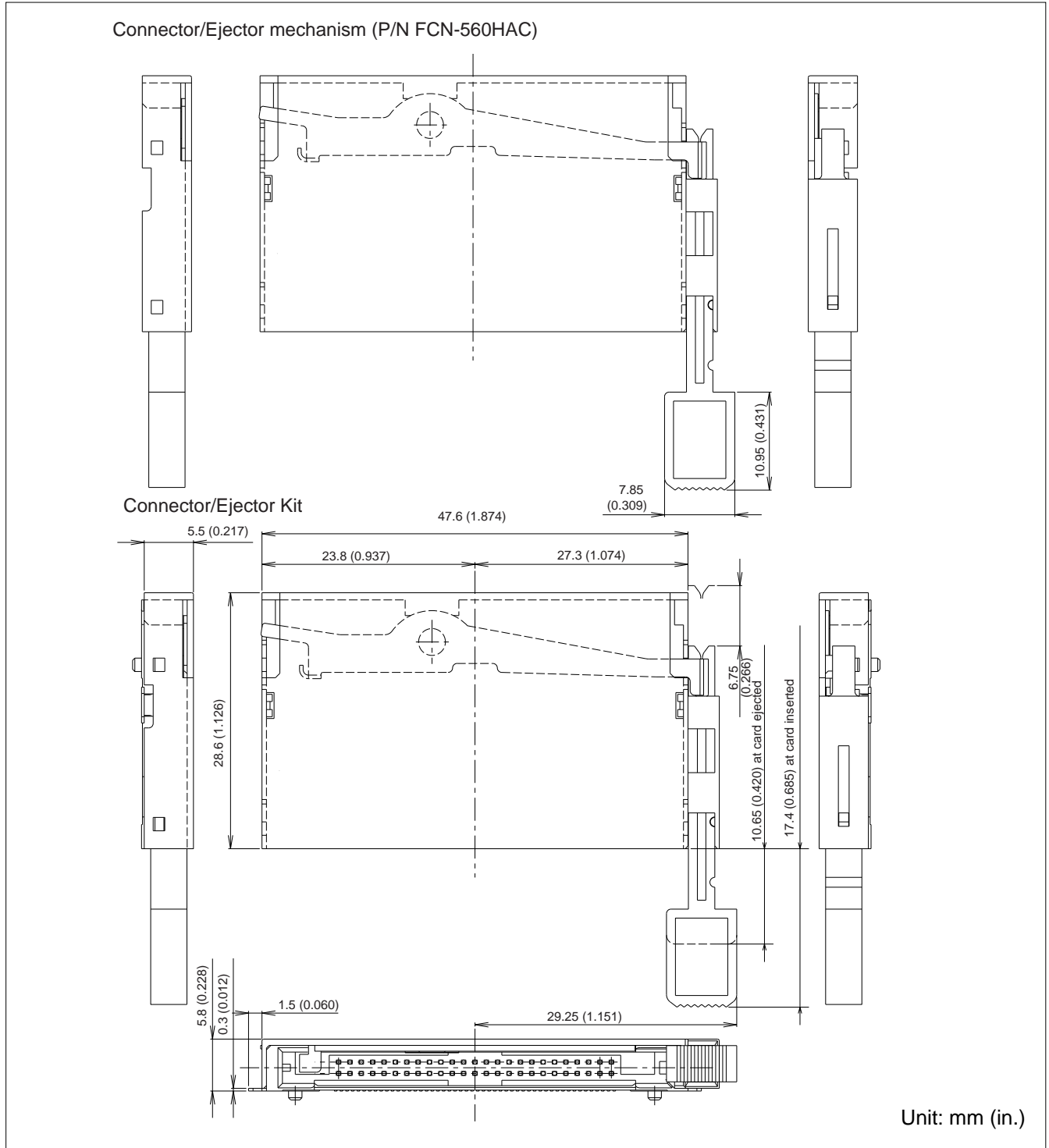

### ■ ORDERING PART NUMBER FOR CONNECTOR/EJECTOR KIT

FCN-568H050-G/A1AC



# 560H Series (Compact Flash Connector)

RIGHT ANGLE PLUG, SMT TYPE (WITH EJECTOR, TO BE MOUNTED ON BACK OF PC BOARD)

## ■ DIMENSIONS

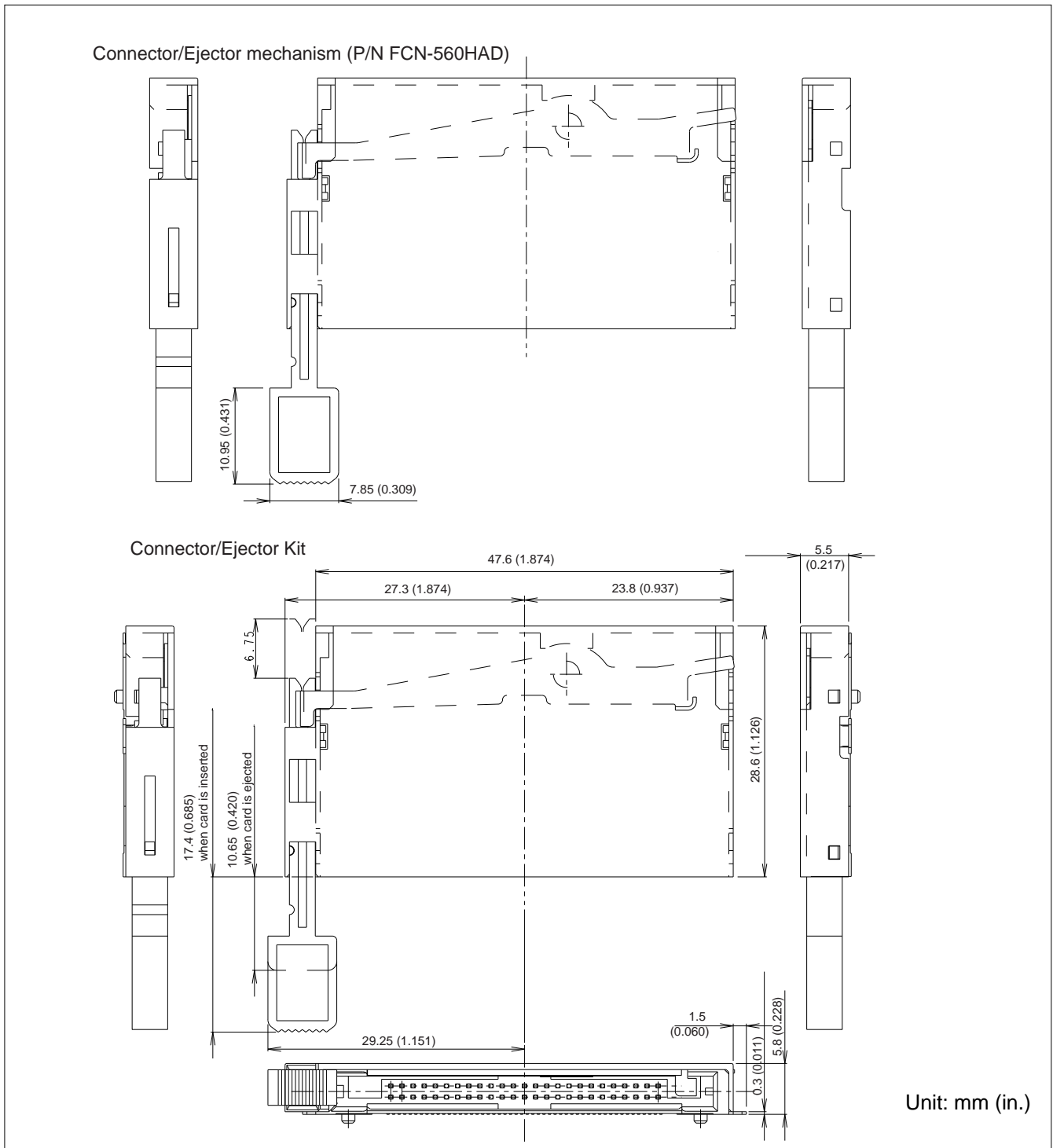

## ■ ORDERING PART NUMBER FOR CONNECTOR/EJECTOR KIT

FCN-568H050-G/A2AD

# 560H Series (Compact Flash Connector)

## RIGHT-ANGLE PLUG, SMT TYPE (WITH NO EJECTOR, 1.64mm RAISED TYPE)

### ■ DIMENSIONS

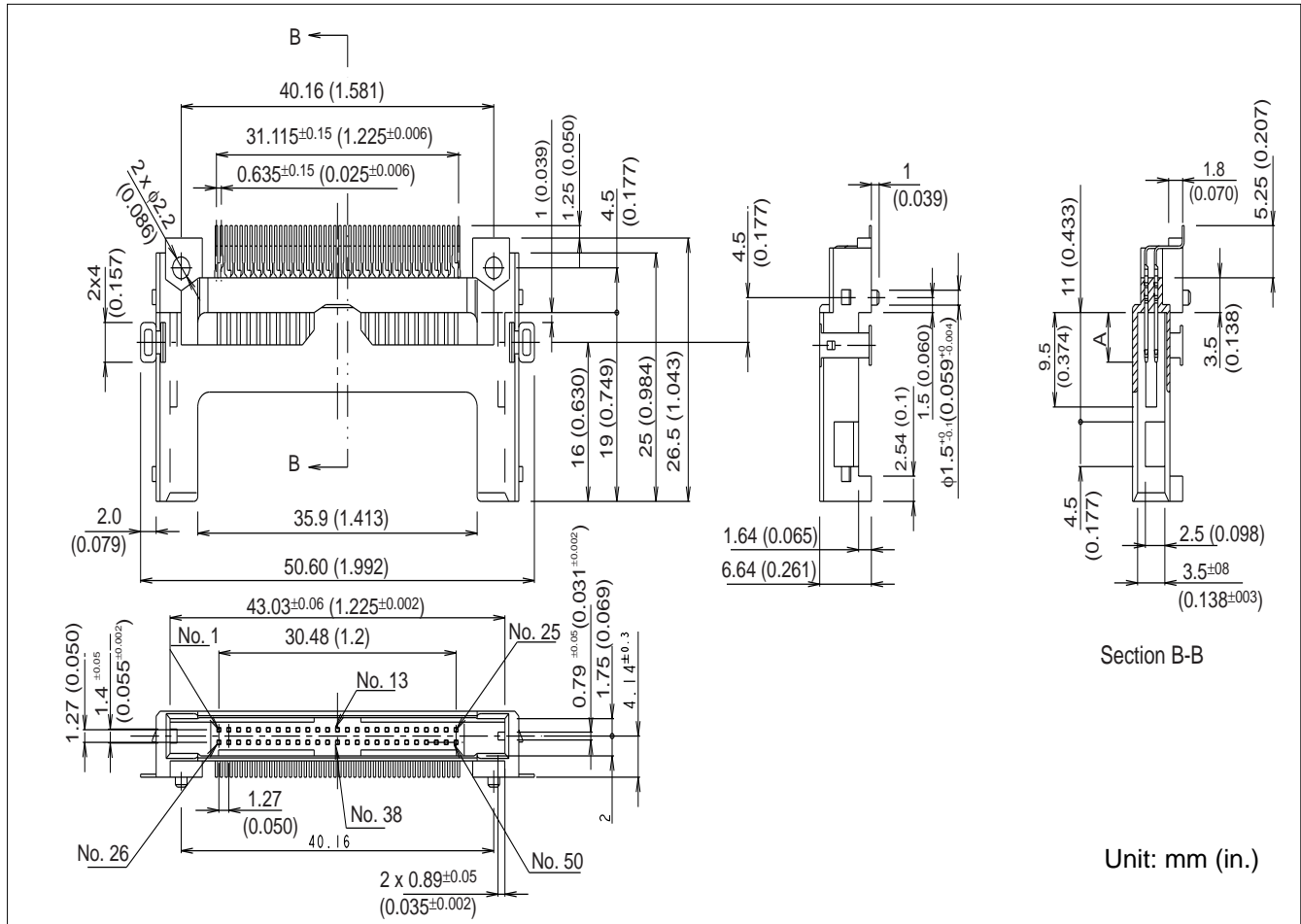

### ■ PC BOARD MOUNTING PATTERN (MOUNTING SIDE)

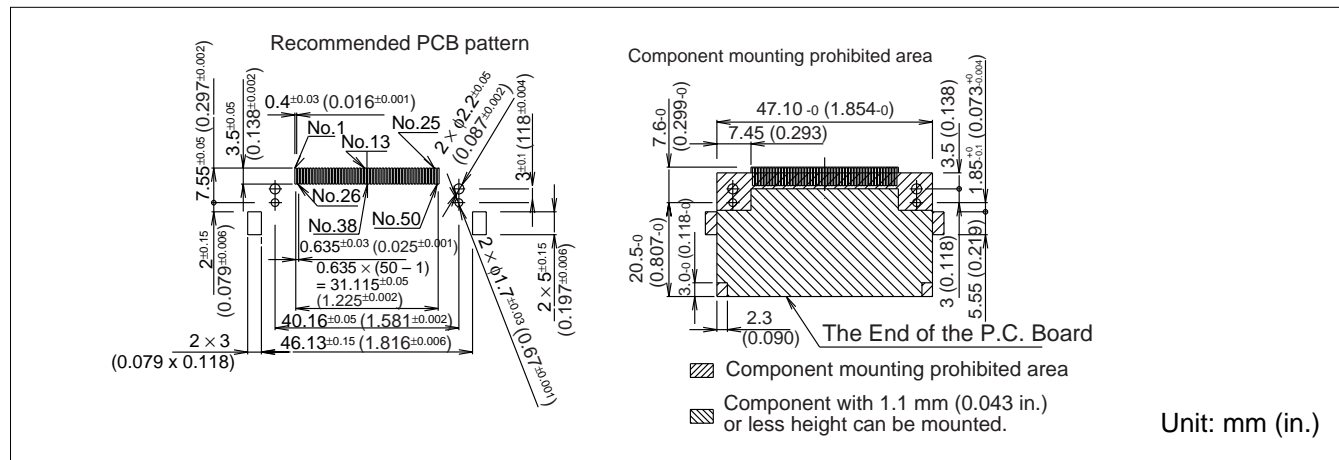

### ■ ORDERING PART NUMBER

FCN-568H050-G/A3

For above connector with ejector mechanism see page 7.

# 560H Series (Compact Flash Connector)

RIGHT-ANGLE PLUG, SMT TYPE (WITH EJECTOR, 1.64mm (0.065 in.) RAISED TYPE)

## ■ DIMENSIONS

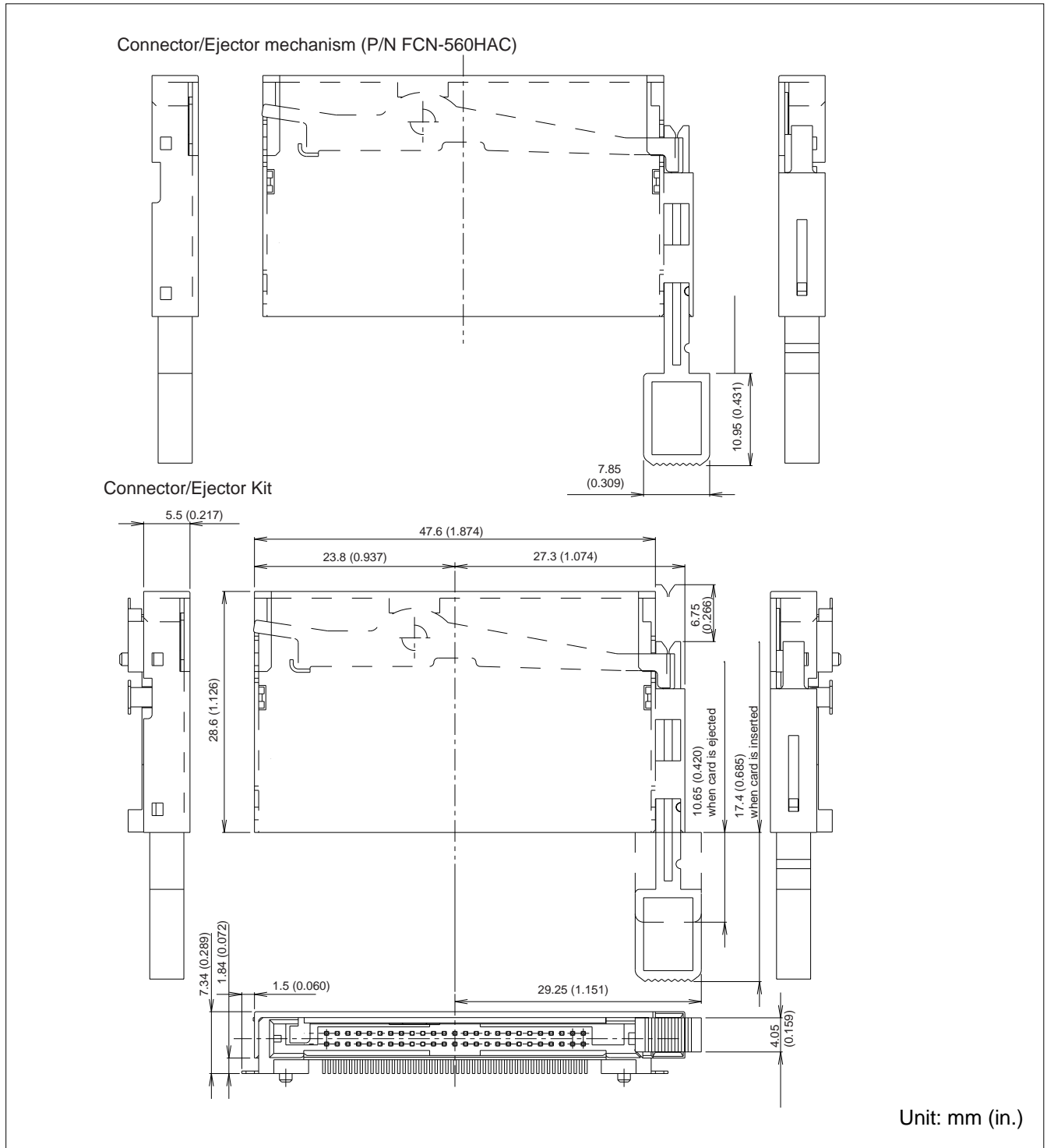

## ■ ORDERING PART NUMBER FOR CONNECTOR/EJECTOR KIT

FCN-568H050-G/A3AC





# 560H Series (Compact Flash Connector)

RIGHT-ANGLE PLUG, SMT TYPE (WITH EJECTOR, 1.64mm (0.065 in.) RAISED TYPE, TO BE MOUNTED ON BACK OF PC BOARD)

## ■ DIMENSIONS

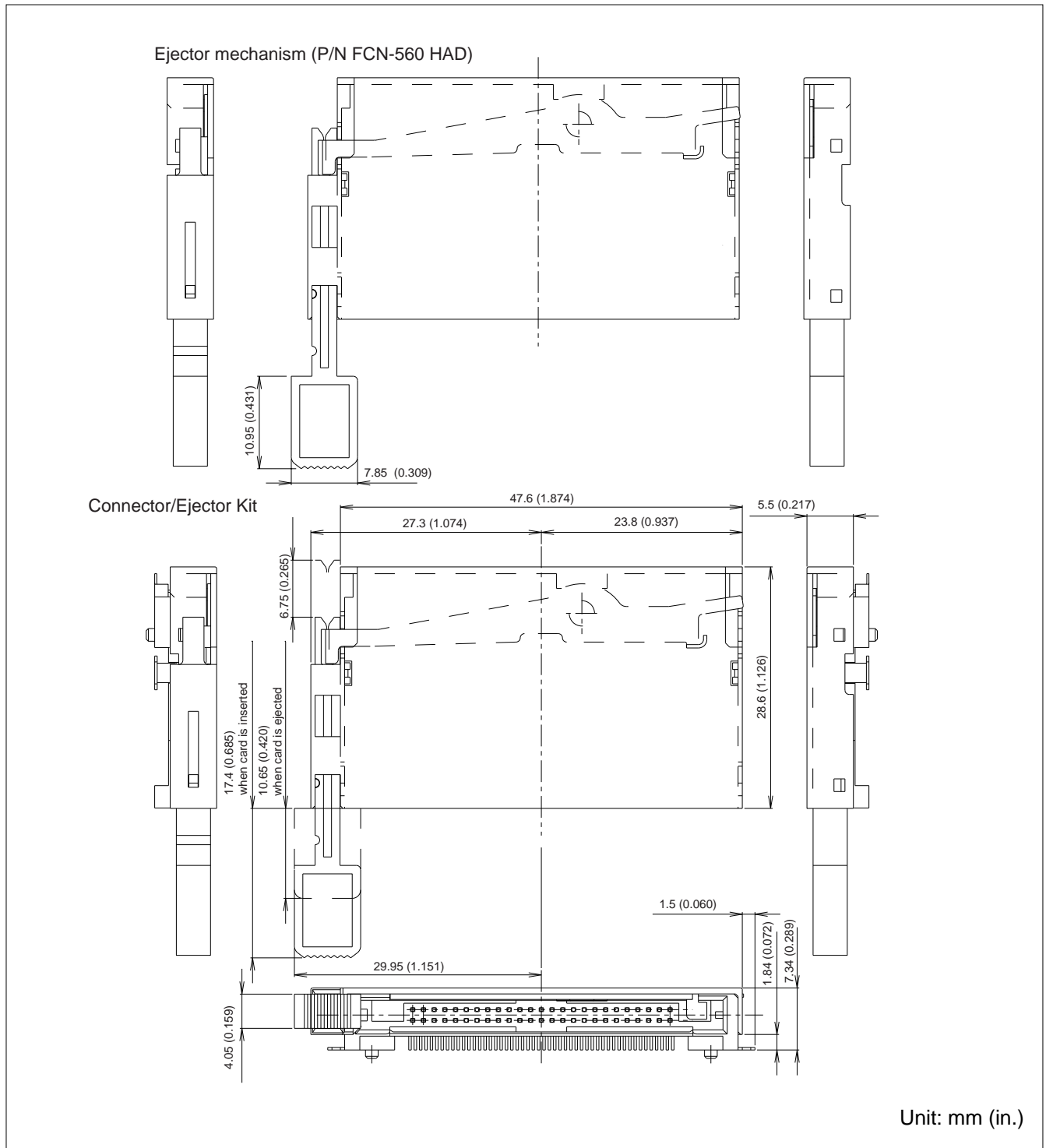

## ■ ORDERING PART NUMBER

FCN-568H050-G/A4AD

# 560H Series (Compact Flash Connector)

FCN-560H Series Connector PLUG (Guide)

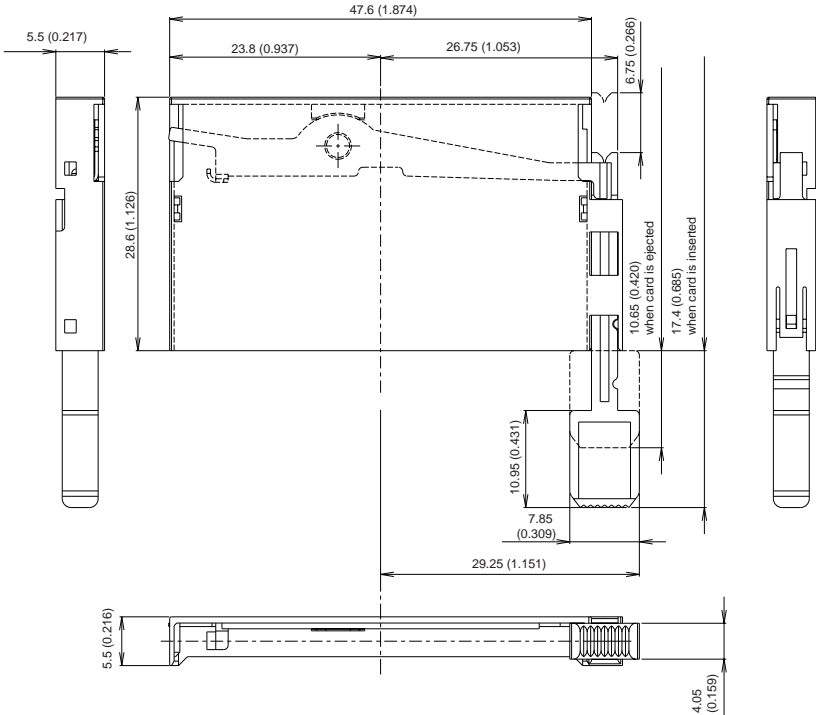

Part No: FCN-560HAC

FCN-560 Series Connector PLUG (GUIDE)

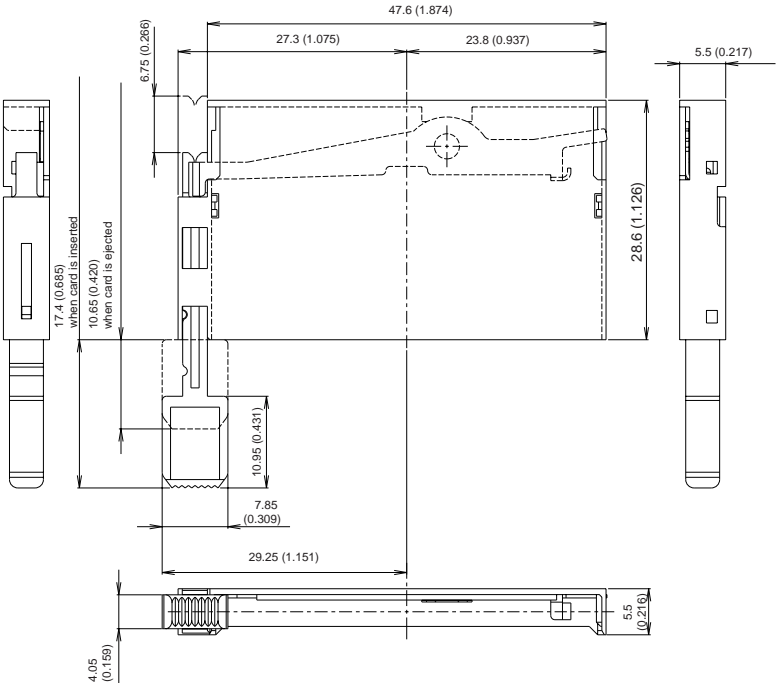

Part No: FCN-560HAD

# 560H Series (Compact Flash Connector)

## Fujitsu Components International Headquarter Offices

### Japan

Fujitsu Component Limited  
Gotanda-Chuo Building  
3-5, Higashigotanda 2-chome, Shinagawa-ku  
Tokyo 141, Japan  
Tel: (81-3) 5449-7010  
Fax: (81-3) 5449-2626  
Email: [promothq@ft.ed.fujitsu.com](mailto:promothq@ft.ed.fujitsu.com)  
Web: [www.fcl.fujitsu.com](http://www.fcl.fujitsu.com)

### North and South America

Fujitsu Components America, Inc.  
250 E. Caribbean Drive  
Sunnyvale, CA 94089 U.S.A.  
Tel: (1-408) 745-4900  
Fax: (1-408) 745-4970  
Email: [marcom@fcai.fujitsu.com](mailto:marcom@fcai.fujitsu.com)  
Web: [www.fcai.fujitsu.com](http://www.fcai.fujitsu.com)

### Europe

Fujitsu Components Europe B.V.  
Diamantlaan 25  
2132 WV Hoofddorp  
Netherlands  
Tel: (31-23) 5560910  
Fax: (31-23) 5560950  
Email: [info.marketing@fceu.fujitsu.com](mailto:info.marketing@fceu.fujitsu.com)  
Web: [www.fceu.fujitsu.com](http://www.fceu.fujitsu.com)

### Asia Pacific

Fujitsu Components Asia Ltd.  
102E Pasir Panjang Road  
#04-01 Citilink Warehouse Complex  
Singapore 118529  
Tel: (65) 375-8560  
Fax: (65) 273-3021  
Email: [fcal@fcal.fujitsu.com](mailto:fcal@fcal.fujitsu.com)  
[www.fcal.fujitsu.com](http://www.fcal.fujitsu.com)

© 2001 Fujitsu Components America, Inc. All company and product names are trademarks or registered trademarks of their respective owners. Rev. 09/2001