

Interference Suppression Film Capacitors MKP Radial Potted Type

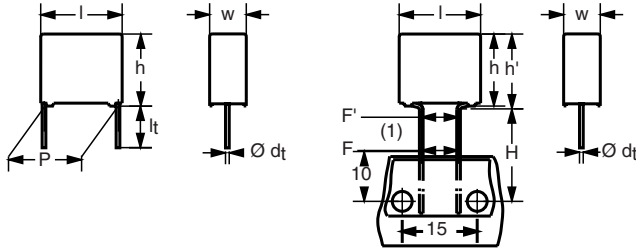

Dimensions in mm

(1) $|F - F'| < 0.3 \text{ mm}$
 $F = 7.5 + 0.6 / - 0.1 \text{ mm}$

FOCUS PRODUCT

APPLICATIONS

X1 class

For X1 electromagnetic interference suppression in across the line applications (50/60 Hz) with a maximum mains voltage of 440 Vac.

For applications limitations please refer page 9.

REFERENCE STANDARDS

"IEC 60384-14 2nd edition and EN 132400"

"IEC 60065, pass. flamm. class B"

250 V: UL1414

440 V: UL1283; CSA-C22.2 No.8; ENEC

MARKING

C-value; tolerance; rated voltage; sub-class; manufacturer's type designation; code for dielectric material; manufacturer location; manufacturer's emblem; year and week

DIELECTRIC

Polypropylene film

ELECTRODES

Metallized film

CONSTRUCTION

Mono construction

RATED VOLTAGE

AC 440 V; 50 to 60 Hz

FEATURES

15 to 27.5 mm lead pitch and 15 mm bent back to 7.5 mm. Supplied loose in box, taped on ammpack or reel

Lead (Pb)-free product

RoHS-compliant product



RoHS
COMPLIANT

PERMISSIBLE DC VOLTAGE

DC 1000 V

ENCAPSULATION

Plastic case, epoxy resin sealed, flame retardant UL-class 94 V-0

CLIMATIC TESTING CLASS ACC. TO EN 60068-1

55/105/56/B

CAPACITANCE RANGE (E12 SERIES)

E12 series 0.01 to 1 μF

Preferred values acc. to E6

CAPACITANCE TOLERANCE

$\pm 20 \%$; $\pm 10 \%$; $\pm 5 \%$

LEADS

Tinned wire

RATED TEMPERATURE

105 °C

MAXIMUM APPLICATION TEMPERATURE

105 °C

DETAIL SPECIFICATION

For more detailed data and test requirements contact:

rfi@vishay.com

COMPOSITION OF CATALOG NUMBER

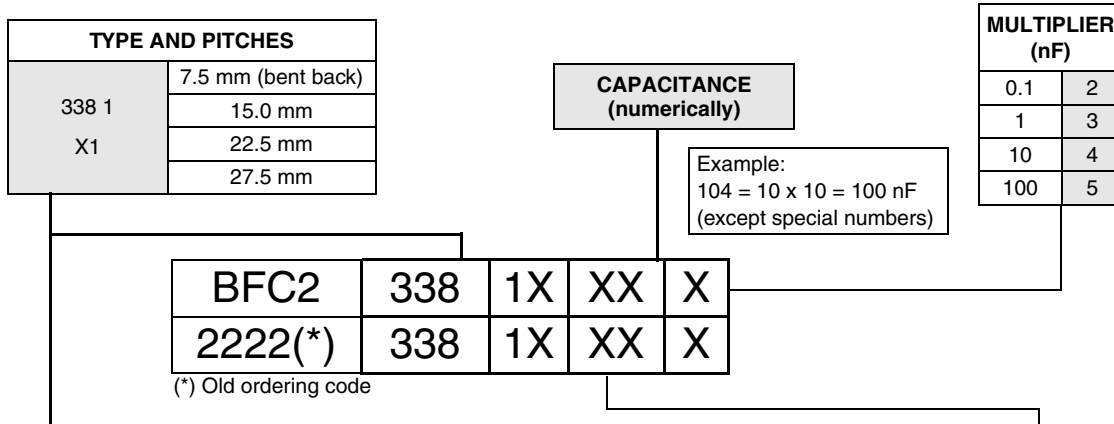

TYPE	PACKAGING	LEAD CONFIGURATION	C-TOL	PREFERRED TYPES
338 1 X1	loose in box	lead length 3.5 ± 0.3 mm	± 20 %	BFC2 338 10 ...
		lead length 5.0 ± 1.0 mm		BFC2 338 12 ...
		lead length 25.0 ± 2.0 mm		BFC2 338 14 ...
	taped on reel	bent back to 7.5 mm; H = 16.0 mm; P ₀ = 15.0 mm; reel diameter = 500 mm		BFC2 338 16 ...
		ALTERNATIVE TAPED VERSIONS		ON REQUEST
338 1 X1	taped on reel	H = 18.5 mm; for P ₀ = 12.7 mm; reel diameter = 500 mm	± 20 %	BFC2 338 17 ...
		ALTERNATIVE C-TOL		ON REQUEST
338 1 X1	loose in box	lead length 3.5 ± 0.3 mm	± 10 %	See tables for detail
			± 5 %	
		lead length 5.0 ± 1.0 mm	± 10 %	
	± 5 %			
	taped on reel	lead length 25.0 ± 2.0 mm	± 10 %	
			± 5 %	
Bent back to 7.5 mm; H = 16.0 mm; P ₀ = 15.0 mm; reel diameter = 500 mm			± 10 %	
	H = 18.5 mm; P ₀ = 12.7 mm; reel diameter = 500 mm	± 5 %		
		± 10 %		
		± 5 %		

Note

For detailed tape specifications refer to Packaging information” www.vishay.com/docs/28139/packinfo.pdf”

SPECIFIC REFERENCE DATA MKP 338 1 440 VAC (X1)

DESCRIPTION	VALUE	
Tangent of loss angle: C ≤ 470 nF C > 470 nF	at 1 kHz	at 10 kHz
	≤ 10 × 10 ⁻⁴ ≤ 20 × 10 ⁻⁴	≤ 20 × 10 ⁻⁴ ≤ 70 × 10 ⁻⁴
Rated voltage pulse slope (dU/dt) _R at 615 V: Pitch = 15 mm and 7.5 mm (bent back) Pitch = 22.5 mm Pitch = 27.5 mm	250 V/μs 150 V/μs 100 V/μs	
R between leads, for C ≤ 0.33 μF at 100 V; 1 min	> 15 000 MΩ	
R between leads, for C > 0.33 μF at 100 V; 1 min	> 5000 s	
R between leads and case; 100 V; 1 min	> 30 000 MΩ	
Withstanding (DC) voltage (cut off current 10 mA); rise time 100 V/s	3400 V; 1 min	
Withstanding (AC) voltage between leads and case	2380 V; 1 min	



Interference Suppression Film Capacitors Vishay BCcomponents
MKP Radial Potted Type

MKP 338 1 GENERAL DATA

$U_{Rac} = 440 V$; $C - tol = 20 \% (U_{Rdc} = 1000 V)$

C (μF)	DIMENSIONS W x H x L (mm)	MASS (g) ⁽¹⁾	CATALOG NUMBER BFC2 338 1..... AND PACKAGING						
			LOOSE IN BOX					TAPED	
			Short leads			Long leads		reel diameter = 500 mm H = 18.5 mm; P ₀ = 12.7 mm	
			$L_t = 3.5 \pm 0.3$ mm	$L_t = 5.0 \pm 1.0$ mm	SPQ	$L_t = 25.0 \pm 2.0$ mm	SPQ	LAST 5 DIGITS	SPQ
LAST 5 DIGITS			LAST 5 DIGITS		LAST 5 DIGITS				
Pitch = 15.0 ± 0.4 mm; d_t = 0.60 ± 0.06 mm									
0.01	5.0 × 11.0 × 17.5	1.0	10103	12103	1000	14103	1000	17103	1100
0.012			10123	12123		14123		17123	
0.015			10153	12153		14153		17153	
0.018			10183	12183		14183		17183	
0.022			10223	12223		14223		17223	
0.027	6.0 × 12.0 × 17.5	1.4	10273	12273	1000	14273	1000	17273	900
0.033			10333	12333		14333		17333	
Pitch = 15.0 ± 0.4 mm; d_t = 0.80 ± 0.08 mm									
0.039	7.0 × 13.5 × 17.5	1.8	10393	12393	750	14393	500	17393	800
0.047			10473	12473		14473		17473	
0.056	8.5 × 15.0 × 17.5	2.4	10563	12563	750	14563	500	17563	650
0.068			10683	12683		14683		17683	
0.082	10.0 × 16.5 × 17.5	3.0	10823	12823	500	14823	450	17823	600
0.1			10104	12104		14104		17104	
Pitch = 22.5 ± 0.4 mm; d_t = 0.80 ± 0.08 mm									
0.12	8.5 × 18.0 × 26.0	3.8	10124	12124	200	14124	250	17124	450
0.15			10154	12154		14154		17154	
0.18	10.0 × 19.5 × 26.0	6.8	10184	12184	200	14184	200	17184	350
0.22			10224	12224		14224		17224	
Pitch = 27.5 ± 0.4 mm; d_t = 0.80 ± 0.08 mm									
0.27	11.0 × 21.0 × 31.0	7.4	10274	12274	100	14274	125		
0.33	13.0 × 23.0 × 31.0	9.2	10334	12334	100	14334	125		
0.39	15.0 × 25.0 × 31.0	12.3	10394	12394	100	14394	125		
0.47			10474	12474		14474			
0.56	18.0 × 28.0 × 31.0	16.1	10564	12564	100	14564	100		
0.68			10684	12684		14684			
0.82	21.0 × 31.0 × 31.0	20.3	10824	12824	50	14824	75		
1			10105	12105		14105			

Note

- Weight for short lead products only

BENT BACK PITCH 7.5 mm

C (μF)	DIMENSIONS W x H x L (mm)	MASS (g) ⁽²⁾	CATALOG NUMBER BFC2 338 1 AND PACKAGING						
			LOOSE IN BOX					TAPED	
			Short leads			Long leads		reel diameter = 500 mm ⁽¹⁾ H = 16.0 mm; P ₀ = 15.0 mm	
			$L_t = 3.5 \pm 0.3$ mm	$L_t = 5.0 \pm 1.0$ mm	SPQ	$L_t = 25.0 \pm 2.0$ mm	SPQ	LAST 5 DIGITS	SPQ
LAST 5 DIGITS			LAST 5 DIGITS		LAST 5 DIGITS				
Original pitch = 15.0 mm; bent back pitch = 7.5 ± 0.4 mm; d_t = 0.60 ± 0.06 mm									
0.010	5.0 × 13.0 × 17.5	1.0						16103	950
0.012								16123	
0.015								16153	
0.018								16183	
0.022								16223	
0.027	6.0 × 14.0 × 17.5	1.4						16273	800
0.033								16333	

C (μ F)	DIMENSIONS W x H x L (mm)	MASS (g) ⁽²⁾	CATALOG NUMBER BFC2 338 1 AND PACKAGING						
			LOOSE IN BOX					TAPED reel diameter = 500 mm ⁽¹⁾ H = 16.0 mm; P ₀ = 15.0 mm	
			Short leads			Long leads		LAST 5 DIGITS	SPQ
			L _t = 3.5 ± 0.3 mm LAST 5 DIGITS	L _t = 5.0 ± 1.0 mm LAST 5 DIGITS	SPQ	L _t = 25.0 ± 2.0 mm LAST 5 DIGITS	SPQ		
Original pitch = 15.0 mm; bent back pitch = 7.5 ± 0.4 mm; dt = 0.80 ± 0.08 mm									
0.039 0.047	7.0 × 15.5 × 17.5	1.8						16393 16473	700
0.056 0.068	8.5 × 17.0 × 17.5	1.4						16563 16683	550
0.082 0.100	10.0 × 18.5 × 17.5	3.0						16823 16104	500

Notes

1. Reel diameter = 356 mm is available on request
2. Weight for short lead product only

U_{Rac} = 440 V; C-tol = ± 10 % (U_{Rdc} = 1000 V)

C (μ F)	DIMENSIONS W x H x L (mm)	MASS (g) ⁽¹⁾	CATALOG NUMBER BFC2 338 1 AND PACKAGING						
			LOOSE IN BOX					TAPED reel diameter = 500 mm ⁽¹⁾ H = 18.5 mm; P ₀ = 12.7 mm	
			Short leads			Long leads		LAST 5 DIGITS	SPQ
			L _t = 3.5 ± 0.3 mm LAST 5 DIGITS	L _t = 5.0 ± 1.0 mm LAST 5 DIGITS	SPQ	L _t = 25.0 ± 2.0 mm LAST 5 DIGITS	SPQ		
Pitch = 15.0 ± 0.4 mm; d_t = 0.60 ± 0.06 mm									
0.010 0.012 0.015 0.018	5.0 × 11.0 × 17.5	1.0	18114 18115 18116 18117	18314 18315 18316 18317	1000	18514 18515 18516 18517	1000	18914 18915 18916 18917	1100
0.022 0.027	6.0 × 12.0 × 17.5	1.4	18118 18119	18318 18319	1000	18518 18519	1000	18918 18919	900
Pitch = 15.0 ± 0.4 mm; d_t = 0.80 ± 0.08 mm									
0.033 0.039	7.0 × 13.5 × 17.5	1.8	18121 18122	18321 18322	750	18521 18522	500	18921 18922	800
0.047 0.056	8.5 × 15.0 × 17.5	2.4	18123 18124	18323 18324	750	18523 18524	500	18923 18924	650
0.068 0.082	10.0 × 16.5 × 17.5	3.0	18125 18126	18325 18326	500	18525 18526	450	18925 18926	600
Pitch = 22.5 ± 0.4 mm; d_t = 0.80 ± 0.08 mm									
0.10 0.12 0.15	7.0 × 16.5 × 26.0	2.9	18127 18128 18129	18327 18328 18329	200	18527 18528 18529	250	18927 18928 18929	550 450
0.18	10.0 × 19.5 × 26.0	6.8	18131	18331	200	18531	200	18931	350
Pitch = 27.5 ± 0.4 mm; d_t = 0.80 ± 0.08 mm									
0.22 0.27	11.0 × 21.0 × 31.0	7.4	18132 18133	18332 18333	100	18532 18533	125		
0.33	13.0 × 23.0 × 31.0	9.2	18134	18334	100	18534	125		
0.39 0.47	15.0 × 25.0 × 31.0	12.3	18135 18136	18335 18336	100	18535 18536	125		
0.56 0.68	18.0 × 28.0 × 31.0	16.1	18137 18138	18337 18338	100	18537 18538	100		
0.82	21.0 × 31.0 × 31.0	20.3	18139	18339	50	18539	75		

Note

1. Weight for short lead products only



Interference Suppression Film Capacitors Vishay BCcomponents
MKP Radial Potted Type

BENT BACK PITCH 7.5 mm

C (μ F)	DIMENSIONS W x H x L (mm)	MASS (g) ⁽²⁾	CATALOG NUMBER BFC2 338 1 AND PACKAGING						
			LOOSE IN BOX				TAPED		
			Short leads			Long leads			reel diameter = 500 mm H = 18.5 mm; P ₀ = 12.7 mm
			L _t = 3.5 ± 0.3 mm	L _t = 5.0 ± 1.0 mm	SPQ	L _t = 25.0 ± 2.0 mm	SPQ	LAST 5 DIGITS	SPQ
LAST 5 DIGITS	LAST 5 DIGITS		LAST 5 DIGITS						
Original pitch = 15.0 mm; bent back pitch = 7.5 ± 0.4 mm; dt = 0.60 ± 0.06 mm									
0.010 0.012 0.015 0.018	5.0 x 13.0 x 17.5	1.0					18714 18715 18716 18717	950	
0.022 0.027	6.0 x 14.0 x 17.5	1.4					18718 18719	800	
Original pitch = 15.0 mm; bent back pitch = 7.5 ± 0.4 mm; dt = 0.80 ± 0.08 mm									
0.033 0.039	7.0 x 15.5 x 17.5	1.8					18721 18722	700	
0.047 0.056	8.5 x 17.0 x 17.5	2.4					18723 18724	550	
0.068 0.082	10.0 x 18.5 x 17.5	3.0					18725 18726	500	

Notes

1. Reel diameter = 356 mm is available on request
2. Weight for short lead products only

U_{Rac} = 440 V; C-tol = ± 5 % (U_{Rdc} = 1000 V)

C (μ F)	DIMENSIONS W x H x L (mm)	MASS (g) ⁽¹⁾	CATALOG NUMBER BFC2 338 1 AND PACKAGING						
			LOOSE IN BOX				TAPED		
			Short leads			Long leads			reel diameter = 500 mm ⁽¹⁾ H = 18.5 mm; P ₀ = 12.7 mm
			L _t = 3.5 ± 0.3 mm	L _t = 5.0 ± 1.0 mm	SPQ	L _t = 25.0 ± 2.0 mm	SPQ	LAST 5 DIGITS	SPQ
LAST 5 DIGITS	LAST 5 DIGITS		LAST 5 DIGITS						
Pitch = 15.0 ± 0.4 mm; d_t = 0.60 ± 0.06 mm									
0.010 0.012 0.015 0.018	5.0 x 11.0 x 17.5	1.0	18214 18215 18216 18217	18414 18415 18416 18417	1000	18614 18615 18616 18617	18934 18935 18936 18937	1100	
0.022 0.027	6.0 x 12.0 x 17.5	1.4	18218 18219	18418 18419	1000	18618 18619	18938 18939	900	
Pitch = 15.0 ± 0.4 mm; d_t = 0.80 ± 0.08 mm									
0.033 0.039	7.0 x 13.5 x 17.5	1.8	18221 18222	18421 18422	750	18621 18622	18941 18942	800	
0.047 0.056	8.5 x 15.0 x 17.5	2.4	18223 18224	18423 18424	750	18623 18624	18943 18944	650	
0.068 0.082	10.0 x 16.5 x 17.5	3.0	18225 18226	18425 18426	500	18625 18626	18945 18946	600	
Pitch = 22.5 ± 0.4 mm; d_t = 0.80 ± 0.08 mm									
0.10 0.12	8.5 x 18.0 x 26.0	3.8	18227 18228	18427 18428	200	18627 18628	18947 18948	450	
0.15 0.18	10.0 x 19.5 x 26.0	4.4	18229 18231	18429 18431	200	18629 18631	18949 18951	350	

C (μ F)	DIMENSIONS W x H x L (mm)	MASS (g) ⁽¹⁾	CATALOG NUMBER BFC2 338 1 AND PACKAGING						
			LOOSE IN BOX				TAPED		
			Short leads			Long leads			reel diameter = 500 mm ⁽¹⁾ H = 18.5 mm; P ₀ = 12.7 mm
			$L_t =$ 3.5 \pm 0.3 mm	$L_t =$ 5.0 \pm 1.0 mm	SPQ	$L_t =$ 25.0 \pm 2.0 mm	SPQ	LAST 5 DIGITS	SPQ
LAST 5 DIGITS	LAST 5 DIGITS		LAST 5 DIGITS						
Pitch = 27.5 \pm 0.4 mm; d_t = 0.80 \pm 0.08 mm									
0.22	11.0 x 21.0 x 31.0	7.4	18232	18432	100	18632	125		
0.27	13.0 x 23.0 x 31.0	9.2	18233	18433	100	18623	125		
0.33			18234	18434		18624			
0.39	15.0 x 25.0 x 31.0	12.3	18235	18435	100	18635	125		
0.47			18236	18436		18636			
0.56	18.0 x 28.0 x 31.0	16.1	18237	18437	100	18637	100		
0.68			18238	18438		18638			
0.82	21.0 x 31.0 x 31.0	20.3	18239	18349	50	18639	75		

Note

1. Weight for short lead product only

BENT BACK PITCH 7.5 mm

C (μ F)	DIMENSIONS w x h x L (mm)	MASS (g) ⁽²⁾	CATALOG NUMBER BFC2 338 1 AND PACKAGING						
			LOOSE IN BOX				TAPED		
			Short leads			Long leads			reel diameter = 500 mm ⁽¹⁾ H = 16.0 mm; P ₀ = 15.0 mm
			$L_t =$ 3.5 \pm 0.3 mm	$L_t =$ 5.0 \pm 1.0 mm	SPQ	$L_t =$ 25.0 \pm 2.0 mm	SPQ	LAST 5 DIGITS	SPQ
LAST 5 DIGITS	LAST 5 DIGITS		LAST 5 DIGITS						
Original pitch = 15.0 mm; bent back pitch = 7.5 \pm 0.4 mm; dt = 0.60 \pm 0.06 mm									
0.010	5.0 x 13.0 x 17.5	1.0					18814	950	
0.012							18815		
0.015							18816		
0.018							18817		
0.022	6.0 x 14.0 x 17.5	1.4					18818	800	
0.027							18819		
Original pitch = 15.0 mm; bent back pitch = 7.5 \pm 0.4 mm; dt = 0.80 \pm 0.08 mm									
0.033	7.0 x 15.5 x 17.5	1.8					18821	700	
0.039							18822		
0.047	8.5 x 17.0 x 17.5	2.4					18823	550	
0.056							18824		
0.068	10.0 x 18.5 x 17.5	3.0					18825	500	
0.082							18826		

Notes

1. Reel diameter = 356 mm is available on request
2. Weight for short lead product only

Interference Suppression Film Capacitors Vishay BCcomponents
MKP Radial Potted Type

SAFETY APPROVALS X1	VOLTAGE	VALUE	FILE NUMBERS
EN132400	440 V (AC)	10 nF to 1 μ F	14220
UL1414	250 V (AC)	10 nF to 1 μ F	E112471
UL1283 and CSA-C22.2 No.8	440 V (AC)	10 nF to 1 μ F	E109565

The Enec-approval together with the CB-Certificate replace all national marks of the following countries (they have already signed the ENEC-Agreement): Austria; Belgium; Czech. Republic; Denmark; Finland; France; Germany; Greece; Hungary; Ireland; Italy; Luxembourg; Netherlands; Norway; Portugal; Slovenian; Spain; Switzerland and United Kingdom.

MOUNTING

Normal Use

The capacitors are designed for mounting on printed-circuit boards. The capacitors packed in bandoliers are designed for mounting in printed-circuit boards by means of automatic insertion machines.

For detailed tape specifications refer to Type detail specification "HQN-384-01/102, Packaging information".

Specific Method of Mounting to Withstand Vibration and Shock

In order to withstand vibration and shock tests, it must be ensured that the stand-off pips are in good contact with the printed-circuit board:

- For pitches ≤ 15 mm capacitors shall be mechanically fixed by the leads
- For longer pitches the capacitors shall be mounted in the same way and the body clamped

Space Requirements on printed Circuit Board

The maximum length and width of film capacitors is shown in Figure:

- Eccentricity as in figure. The maximum eccentricity is smaller than or equal to the lead diameter of the product concerned
- Product height with seating plane as given by "IEC 60717" as reference: $h_{max} \leq h + 0.3$ mm

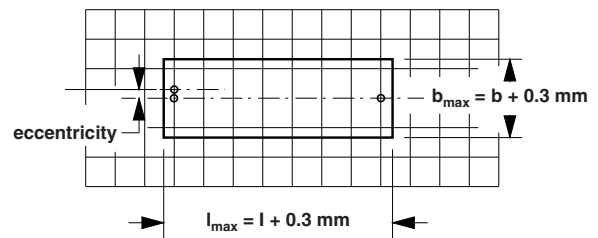

CBA116

Storage Temperature

- Storage temperature: $T_{stg} = 25$ to $+ 40$ °C with RH maximum 80 % without condensation

Ratings and Characteristics Reference Conditions

Unless otherwise specified, all electrical values apply to an ambient temperature of 23 ± 1 °C, an atmospheric pressure of 86 to 106 kPa and a relative humidity of 50 ± 2 %.

For reference testing, a conditioning period shall be applied over 96 ± 4 hours by heating the products in a circulating air oven at the rated temperature and a relative humidity not exceeding 20 %.

CHARACTERISTICS

Capacitance

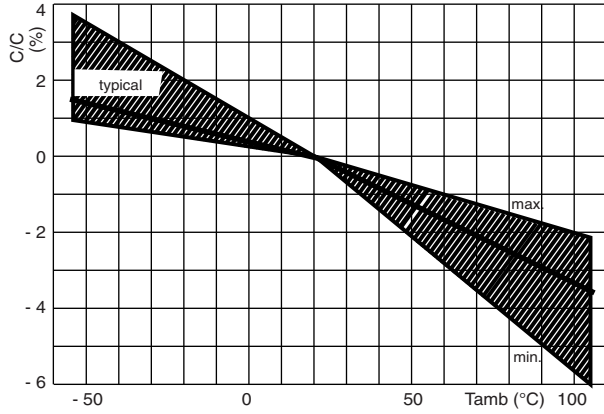

Target of loss angle

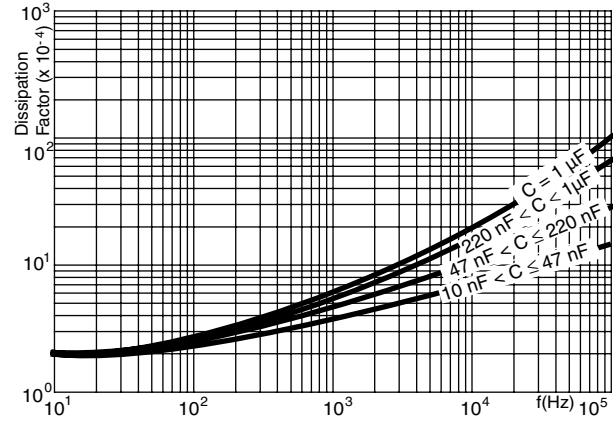

Impedance

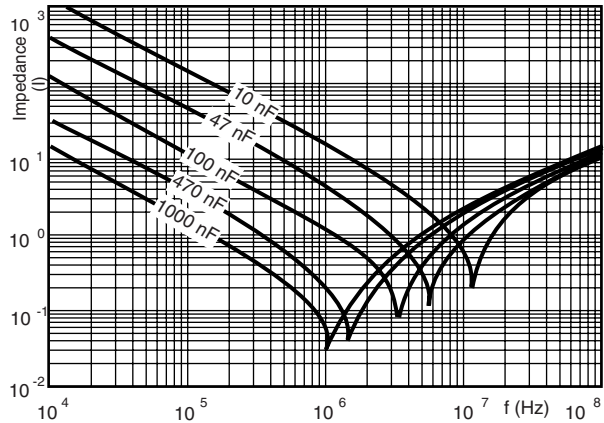

Resonant frequency

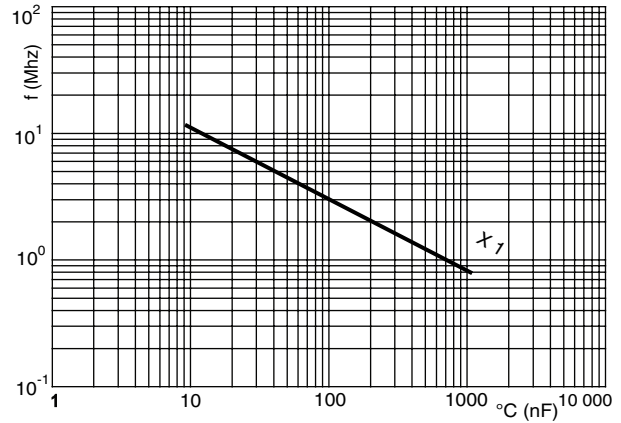

Max RMS voltage and AC current (sinewave)

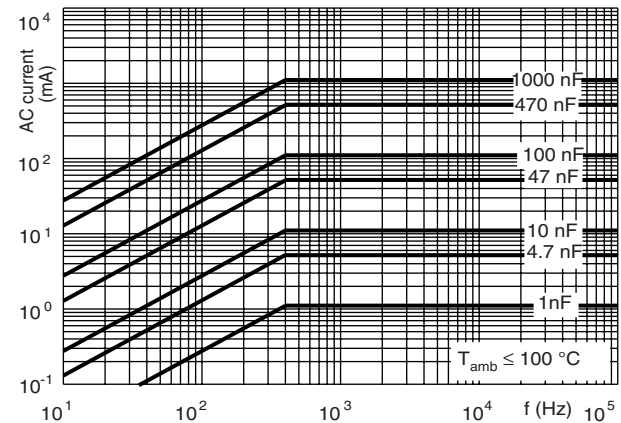
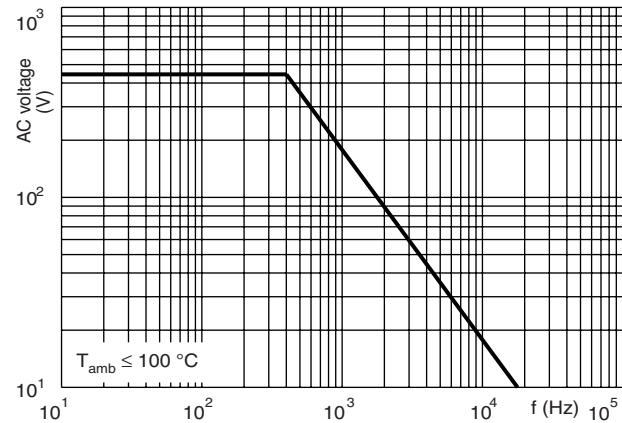



Insulation resistance

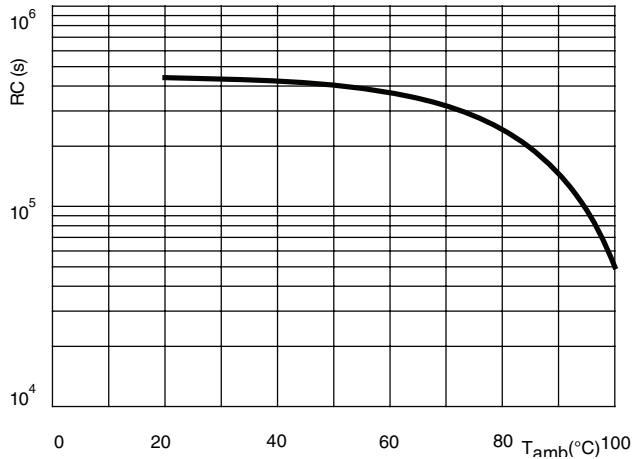

APPLICATION NOTES

- For X1 electromagnetics interference suppression in **across the line applications** (50/60 Hz) with a maximum mains voltage of 440 V (AC).
- These capacitors are not intended for continuous pulse applications. For these situations, capacitors of the AC and pulse programs must be used.
- These capacitors are not intended for series impedance application. For these situations in case of safety approvals are requested, please refer to our special capacitors of 1772 series with internal series connection.
- The maximum ambient temperature must not exceed 105 °C.
- Rated voltage pulse slope:
If the pulse voltage is lower than the rated voltage, the values of the specific reference data can be multiplied by 620 V (DC) and divided by the applied voltage.



Interference Suppression Film Capacitors Vishay BCcomponents
MKP Radial Potted Type

SUB - CLAUSE NUMBER AND TEST	D OR ND	CONDITIONS	PERFORMANCE REQUIREMENTS
4.7 Vibration (see note 3.1) 4.7.2 Final inspection 4.9 Shock (see note 3) 4.9.2 Final measurements		Visual examination Mounting: see Section "Mounting" of this specification Procedure B4 Frequency range: 10 to 55 Hz Amplitude: 0.75 mm or Acceleration 98 m/s ² (whichever is less severe) Total duration 6 h Visual examination Mounting: see Section "Mounting" for more information Pulse shape: half sine Acceleration: 490 m/s ² Duration of pulse: 11 ms Visual examination Capacitance Tangent of loss angle Insulation resistance	No visible damage No visible damage No visible damage $ \Delta C/C \leq 5\%$ of the value measured initially Increase of $\tan \delta$: ≤ 0.008 Compared to values measured initially As specified in Section "Insulation Resistance" of this specification
SUB - GROUP C1 COMBINED SAMPLE OF SPECIMENS OF SUB - GROUPS C1A AND C1B	D		
4.11 Climatic sequence 4.11.1 Initial measurements 4.11.2 Dry heat 4.11.3 Damp heat cyclic Test Db First cycle 4.11.4 Cold 4.11.5 Damp heat cyclic Test Db remaining cycles 4.11.6 Final measurements		Capacitance Measured in 4.4.2 and 4.9.2 Tangent of loss angle: Measured initially in C1A and C1B Temperature: 105 °C Duration: 16 h Temperature: - 55 °C Duration: 2 h Visual examination Capacitance Tangent of loss angle Voltage proof 1900 V (DC); 1 min between term. Insulation resistance	No visible damage Legible marking $ \Delta C/C \leq 5\%$ of the value measured in 4.11.1. Increase of $\tan \delta$: ≤ 0.008 Compared to values measured in 4.11.1. No permanent breakdown or flash-over $\geq 50\%$ of values specified in Section "Insulation resistance" of this specification
SUB - GROUP C2	D		
4.12 Damp heat steady state		56 days, 40 °C, 90 to 95 % RH No load	

Vishay BCcomponents Interference Suppression Film Capacitors
MKP Radial Potted Type

SUB - CLAUSE NUMBER AND TEST	D OR ND	CONDITIONS	PERFORMANCE REQUIREMENTS
4.12.1 Initial measurements 4.12.3 Final measurements		Capacitance Tangent of loss angle at 10 kHz Visual examination Capacitance Tangent of loss angle Voltage proof 1900 V (DC); 1 min between term. Insulation resistance	No visible damage Legible marking $ \Delta C/C \leq 5\%$ of the value measured in 4.12.1. Increase of $\tan \delta$: ≤ 0.008 Compared to values measured in 4.12.1. No permanent breakdown or flash-over $\geq 50\%$ of values specified in Section "Insulation resistance" of this specification
SUB GROUP C3	D		
4.13.1 Initial measurements 4.13 Impulse voltage 4.14 Endurance 4.14.7 Final measurements		Capacitance Tangent of loss angle at 10 kHz 3 successive impulses, full wave, peak voltage: X1: 4 kV Max. 24 pulses Duration: 1000 h 1.25 U_{Rac} at 105 °C Once in every hour the voltage is increased to 1000 V (RMS) for 0.1 s via resistor of $47 \Omega \pm 5\%$ Visual examination Capacitance Tangent of loss angle Voltage proof 1900 V (DC); 1 min between terminations. 2400 V (DC); 1 min between terminations and case. Insulation resistance	No selfhealing breakdowns or flashover No visible damage Legible marking $ \Delta C/C \leq 10\%$ compared to values measured in 4.13.1. Increase of $\tan \delta$: ≤ 0.008 Compared to values measured in 4.13.1. No permanent breakdown or flash-over $\geq 50\%$ of values specified in Section "Insulation resistance" of this specification
SUB - GROUP C 4	D		
4.15 Charge and discharge 4.15.1 Initial measurements 4.15.3 Final measurements		10 000 cycles (50 c/s) charge to UR half sinewave Duration: 5 ms Discharge resistance: $R = \frac{615 \text{ Vdc}}{1.5 \times C((dU)/(dt))}$ $R_{min} = 2.2$ Capacitance Tangent of loss angle at 10 kHz Capacitance	$ \Delta C/C \leq 10\%$ compared to values measured in 4.15.1.

Interference Suppression Film Capacitors Vishay BCcomponents
MKP Radial Potted Type

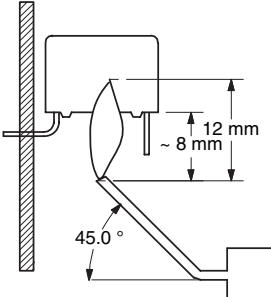
SUB - CLAUSE NUMBER AND TEST	D OR ND	CONDITIONS	PERFORMANCE REQUIREMENTS
		Tangent of loss angle Insulation resistance	Increase of $\tan \delta$: ≤ 0.008 Compared to values measured in 4.15.1. $\geq 50\%$ of values specified in Section "Insulation resistance" of this specification
SUB - GROUP C5	D		
4.16 Radio frequency characteristic		Resonance frequency	As specified in Section "Resonant frequency" of this specification. $\pm 10\%$
SUB - GROUP C6	D		
4.17 Passive flammability Class B		Bore of gas jet: $\varnothing 0.5$ mm Fuel: butane Test duration for actual volume V in mm ³ : $V \leq 250$: 10 s $250 < V \leq 500$: 20 s $500 < V \leq 1750$: 30 s $V > 1750$: 60 s One flame application 	After removing test flame from capacitor, the capacitor must not continue to burn for more than 10 s. No burning particle must drop from the sample.
SUB - GROUP C7	D		
4.18 Active flammability		20 x 4 kV discharges on the test capacitor connected to UR	The cheese cloth around the capacitors shall not burn with a flame. No electrical measurements are required.



Notice

Specifications of the products displayed herein are subject to change without notice. Vishay Intertechnology, Inc., or anyone on its behalf, assumes no responsibility or liability for any errors or inaccuracies.

Information contained herein is intended to provide a product description only. No license, express or implied, by estoppel or otherwise, to any intellectual property rights is granted by this document. Except as provided in Vishay's terms and conditions of sale for such products, Vishay assumes no liability whatsoever, and disclaims any express or implied warranty, relating to sale and/or use of Vishay products including liability or warranties relating to fitness for a particular purpose, merchantability, or infringement of any patent, copyright, or other intellectual property right.

The products shown herein are not designed for use in medical, life-saving, or life-sustaining applications. Customers using or selling these products for use in such applications do so at their own risk and agree to fully indemnify Vishay for any damages resulting from such improper use or sale.