

# WIRE WOUND INDUCTOR - CERAMIC or FERRITE

AISC-1008(F)



**RoHS**  
Compliant



2.92 x 2.79 x 2.29mm

## FEATURES:

- Ceramic or Ferrite Construction assures the utmost in the thermal stability and high SRF
- Exceptionally high Q compared to non-wirewound inductor, especially at high frequencies
- Inductance values available from 4.7 to 10,000nH

## APPLICATIONS:

- Widely applied in the VCO, SAW circuit for GSM, CDMA communications
- Used in hard disk, notebook computer and other electronic equipment

## STANDARD SPECIFICATIONS:

### PARAMETERS

ABRACON P/N:

AISC-1008(F)-xxx

Operating temperature:

-25°C to + 125°C

Storage temperature:

-25°C to + 85°C, 70% RH max.

Abracon Part Number	L (nH)	L. Test Freq (MHz)	Tolerance (±%)	Q Min	Q Test Freq (MHz)	SRF Min (MHz)	R <sub>DC</sub> Max (Ω)	I <sub>DC</sub> Max (mA)
AISC-1008-R0047	4.7	50	10,20	60	1500	>6000	0.11	1000
AISC-1008-R010	10	50	5,10,20	50	500	4100	0.08	1000
AISC-1008-R012	12	50	5,10,20	50	500	3400	0.09	1000
AISC-1008-R015	15	50	5,10,20	50	500	2600	0.13	1000
AISC-1008-R018	18	50	5,10,20	50	350	2600	0.11	1000
AISC-1008-R022	22	50	2,5,10,20	55	350	2400	0.12	1000
AISC-1008-R027	27	50	2,5,10,20	55	350	1700	0.13	1000
AISC-1008-R033	33	50	2,5,10,20	60	350	1700	0.14	1000
AISC-1008-R039	39	50	2,5,10,20	60	350	1600	0.15	1000
AISC-1008-R047	47	50	2,5,10,20	70	350	1600	0.16	1000
AISC-1008-R056	56	50	2,5,10,20	70	350	1400	0.18	1000
AISC-1008-R068	68	50	2,5,10,20	65	350	1200	0.21	1000
AISC-1008-R082	82	50	2,5,10,20	65	350	1000	0.22	1000
AISC-1008-R10	100	25	2,5,10,20	60	350	1000	0.56	650
AISC-1008-R12	120	25	2,5,10,20	60	350	1000	0.63	650
AISC-1008-R15	150	25	2,5,10,20	45	100	850	0.62	580
AISC-1008-R18	180	25	2,5,10,20	45	100	800	0.70	620
AISC-1008-R22	220	25	2,5,10,20	45	100	700	0.80	500
AISC-1008-R27	270	25	2,5,10,20	45	100	700	0.91	500
AISC-1008-R33	330	25	2,5,10,20	45	100	600	1.05	450
AISC-1008-R39	390	25	2,5,10,20	45	100	500	1.12	470
AISC-1008-R47	470	25	2,5,10,20	45	100	500	1.19	470
AISC-1008-R56	560	25	2,5,10,20	45	100	450	1.33	400
AISC-1008-R62	620	25	2,5,10,20	45	100	415	1.40	300
AISC-1008-R68	680	25	2,5,10,20	45	100	375	1.47	400
AISC-1008-R75	750	25	2,5,10,20	45	100	360	1.54	360
AISC-1008-R82	820	25	2,5,10,20	45	100	350	1.61	400
AISC-1008-R91	910	25	2,5,10,20	40	50	320	1.68	380
AISC-1008-1R0	1,000	25	2,5,10,20	35	50	290	1.75	370
AISC-1008-1R2	1,200	7.9	2,5,10,20	35	50	250	2.00	310
AISC-1008-1R5	1,500	7.9	2,5,10,20	28	50	200	2.30	330
AISC-1008-1R8	1,800	7.9	2,5,10,20	28	50	160	2.60	300
AISC-1008-2R2	2,200	7.9	2,5,10,20	28	50	120	2.80	280
AISC-1008-2R7	2,700	7.9	2,5,10,20	22	25	100	3.20	290
AISC-1008-3R3	3,300	7.9	2,5,10,20	22	25	80	3.40	260
AISC-1008-3R9	3,900	7.9	2,5,10,20	20	25	60	3.60	260
AISC-1008-4R7	4,700	7.9	2,5,10,20	20	25	60	4.00	250
AISC-1008-5R6	5,600	7.9	5,10,20	20	25	60	5.70	220
AISC-1008-6R8	6,800	7.9	5,10,20	20	25	60	7.70	180
AISC-1008-8R2	8,200	7.9	5,10,20	20	25	50	10.7	150
AISC-1008F-1R2	1,200	7.9	5,10,20	48	50	210	0.70	650
AISC-1008F-1R5	1,500	7.9	5,10,20	41	50	190	0.75	630
AISC-1008F-1R8	1,800	7.9	5,10,20	39	50	170	0.84	600
AISC-1008F-2R2	2,200	7.9	5,10,20	34	50	150	1.15	520
AISC-1008F-2R7	2,700	7.9	5,10,20	34	50	100	1.28	490
AISC-1008F-3R3	3,300	7.9	5,10,20	32	50	100	1.46	450
AISC-1008F-3R9	3,900	7.9	5,10,20	32	7.9	70	1.56	420
AISC-1008F-4R7	4,700	7.9	5,10,20	31	7.9	60	1.68	400
AISC-1008F-5R6	5,600	7.9	5,10,20	23	7.9	50	1.82	380
AISC-1008F-6R8	6,800	7.9	5,10,20	31	7.9	40	2.00	360
AISC-1008F-8R2	8,200	7.9	5,10,20	23	7.9	40	2.65	330
AISC-1008F-100	10,000	7.9	5,10,20	31	7.9	40	2.95	300

ABRACON IS  
ISO 9001 / QS 9000  
CERTIFIED



Visit [www.abracon.com](http://www.abracon.com) for Terms & Conditions of Sale **Revised: 01.19.10**  
30332 Esperanza, Rancho Santa Margarita, California 92688  
tel 949-546-8000 | fax 949-546-8001 | [www.abracon.com](http://www.abracon.com)

# WIRE WOUND INDUCTOR - CERAMIC or FERRITE

AISC-1008(F)



RoHS  
Compliant



2.92 x 2.79 x 2.29mm

## OPTIONS AND PART IDENTIFICATION:

(Left blank if standard)

AISC - 1008(F) - □□□ - □ - □

Material Code	
Blank	Ceramic
F	Ferrite

**Inductance Code**  
Please refer to the Table above.

Packaging	
T	Tape & Reel

Tolerance Code	
G	±2%
J	±5%
K	±10%
M	±20%

## Electrical Properties for AISC-1008:

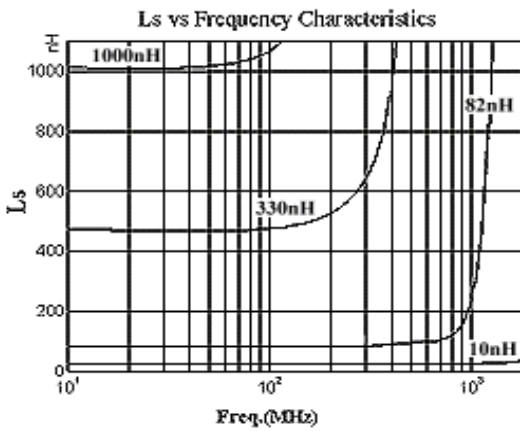

L vs Frequency

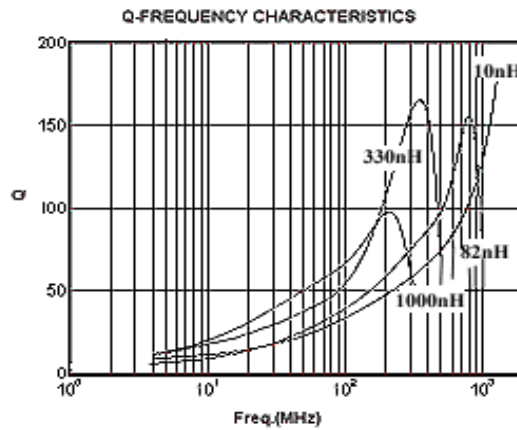

Q vs Frequency

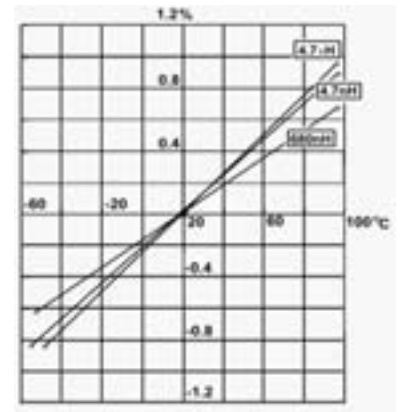

Temperature Characteristic

## Electrical Properties for AISC-1008F

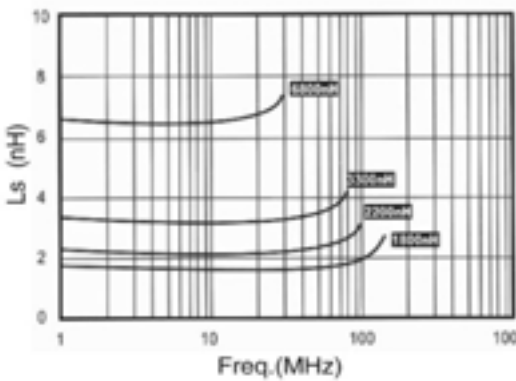

L vs Frequency

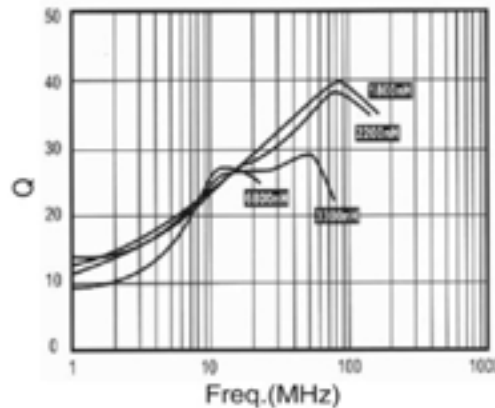

Q vs Frequency

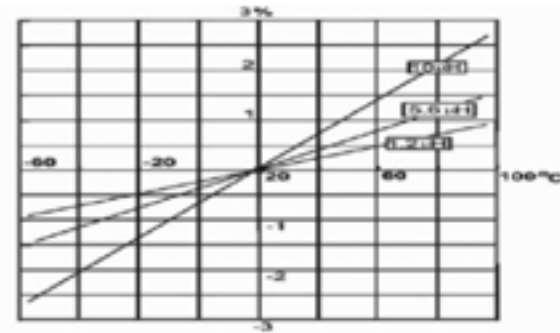

Temperature Characteristic

ABRACON IS  
ISO 9001 / QS 9000  
CERTIFIED



**ABRACON**  
CORPORATION

Visit [www.abracon.com](http://www.abracon.com) for Terms & Conditions of Sale **Revised: 01.19.10**  
30332 Esperanza, Rancho Santa Margarita, California 92688  
tel 949-546-8000 | fax 949-546-8001 | [www.abracon.com](http://www.abracon.com)

# WIRE WOUND INDUCTOR - CERAMIC or FERRITE

AISC-1008(F)



RoHS  
Compliant

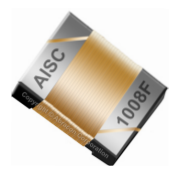

2.92 x 2.79 x 2.29mm

## OUTLINE DRAWING:

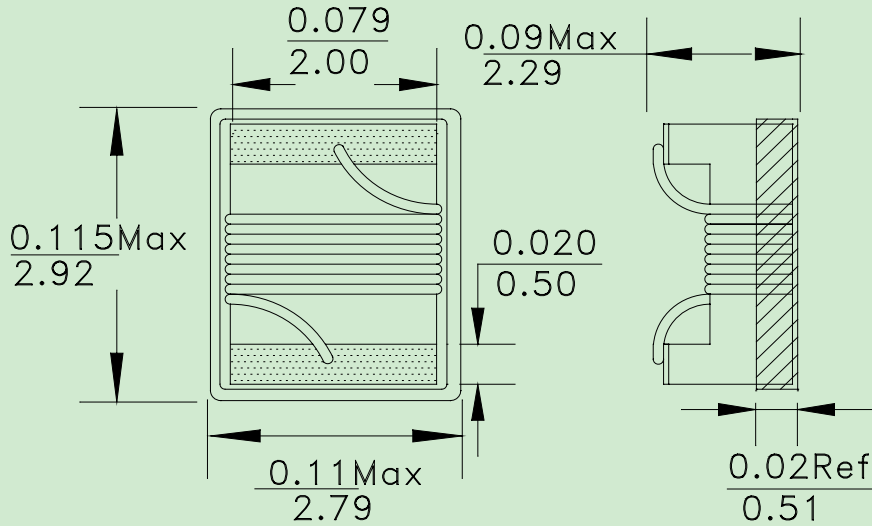

## TAPE & REEL: Tape and reel 2,000pcs/reel

### Dimensions of Tape

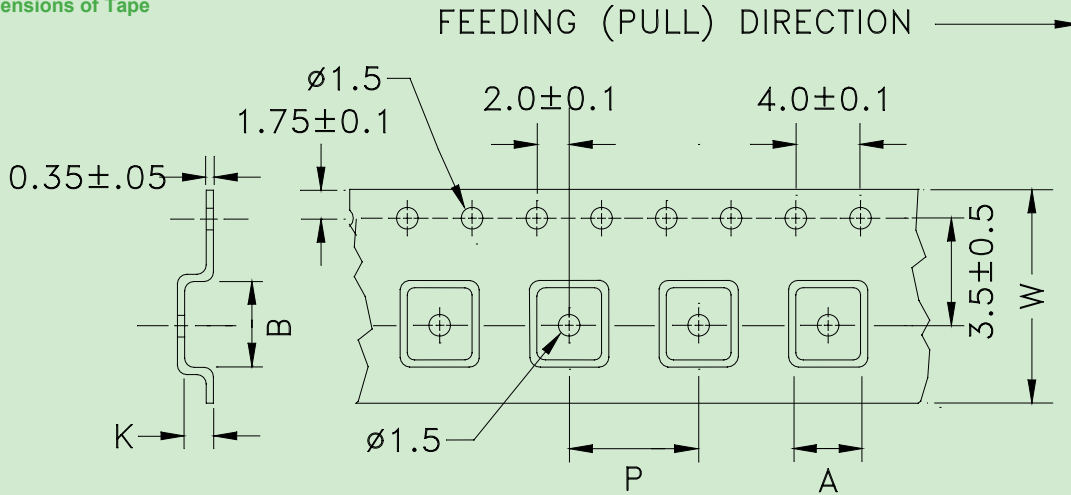

ABRACON P/N	A (mm)	B (mm)	K (mm)	P (mm)	W (mm)	PCS/REEL
AISC-1008(F)	2.9	3.1	2.31	4	8	2,000

### Dimensions of Reel

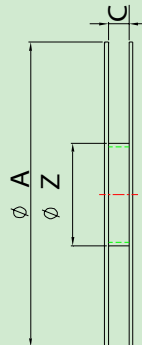
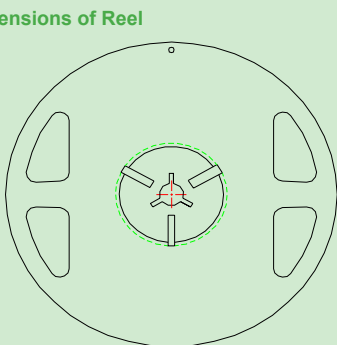

series	A	C	Z
AISC-1008(F)	178±2.0	8.4+1.5	60±1.0

Dimensions: mm

ABRACON IS  
ISO 9001 / QS 9000  
CERTIFIED



Visit [www.abracon.com](http://www.abracon.com) for Terms & Conditions of Sale **Revised: 01.19.10**  
30332 Esperanza, Rancho Santa Margarita, California 92688  
tel 949-546-8000 | fax 949-546-8001 | [www.abracon.com](http://www.abracon.com)