

IMS30 Series: 30W DC/DC Converters
32-75V Input
3.3V & 5.1V, 1.8V & 3.3V Dual Outputs

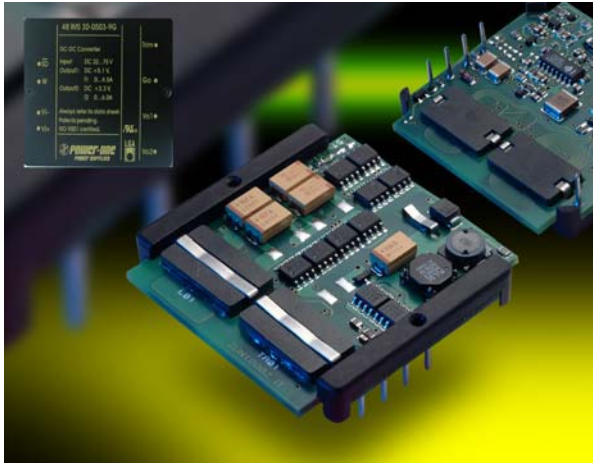

Features

- Single board design
- Industry standard pin-out
- Fixed frequency operation
- Magnetic feedback
- Low profile – 8.5 mm height
- Input/output isolation: 1500 Vdc
- Programmable input undervoltage lockout
- Low conducted and radiated EMI
- Output over-current protection
- Thermal protection (with auto-reset)
- Remote on/off (primary referenced)
- Output over-voltage protection (-0503 version)
- Wide output voltage trim adjust, positive or negative
- Operating temperature to 105°C
- UL, CSA and EN/IEC60950 (3rd ed.) approval pending

Applications

- Distributed power architectures
- Industrial applications
- Telecommunications equipment
- LAN/WAN applications
- Data processing

Description

The IMS30 series of board-mountable converters are industry standard size, low profile, dual output, DC/DC converters and are particularly suitable for applications in industry and telecommunication where variable input voltages or high transients are prevalent. The product provides on-board conversion of standard telecom, datacom and industrial input voltage to isolated low output voltages using highly efficient synchronous rectifiers.

Selection Chart						
Model	Input voltage range, Vdc	Input current, max Adc	Output voltage, Vdc	Output rated current, Adc	Output ripple and noise, mVp-p	Efficiency, %
48IMS30-0503-9G	32 - 75	1.2	5.1	3.1	50	85
			3.3	4.2	50	
48IMS30-0302-9G	32 - 75	1.1	3.3	4.0	40	83
			1.8	5.0	30	

IMS30 Series: 30W DC/DC Converters
32-75V Input
3.3V & 5.1V, 1.8V & 3.3V Dual Outputs

Absolute Maximum Ratings

Stresses in excess of the absolute maximum ratings may cause performance degradation, adversely affect long term reliability and cause permanent damage to the converter. Specifications apply over specified input voltage, output load and temperature range, unless otherwise noted.

Parameter	Conditions/Description	Min	Max	Units
Input voltage (Vin)	Continuous	32	75	Vdc
Transient Input Voltage (Vint)	Transient, 100ms (max 3 sec)		100	Vdc
Operating CaseTemp. (Tc)	All operating conditions	-45	105	°C
Storage Temperature (Ts)		-55	125	°C
ON/OFF Control Voltage (Vrc)	Referenced to -Vin	-10	5	Vdc

Environmental and Mechanical Specifications

Specifications apply over specified input voltage, output load and temperature range, unless otherwise noted.

Parameter	Conditions/Description	Min	Nom	Max	Units
Shock	IEC68-2-27			100	g
Sinusoidal Vibration	IEC68-2-6			10	g
Weight				0.6/17	oz/g
Water Washing	Standard process	Yes			
MTBF	Per Bellcore TR-NWT-000332		2,500		kHrs

Isolation Specifications

Specifications apply over specified input voltage, output load and temperature range, unless otherwise noted.

Parameter	Conditions/Description	Min	Nom	Max	Units
Insulation Safety Rating		Basic			
Isolation Voltage (Vps)				1,500	Vdc
Isolation Resistance (Rps)		10			MΩ
Isolation Capacitance (Cps)			4,700		pF

Input Specifications

Specifications apply over specified input voltage, output load and temperature range, unless otherwise noted.

Parameter	Conditions/Description	Min	Nom	Max	Units
Input Voltage (Vin)	Continuous	32	48	75	Vdc
Input Current when Shutdown	Vin.Nom, Remote Control activated		1	2	mAdc
Input Current No Load	Vin.Nom, Io = 0			100	mAdc
Turn-On Input Voltage (-0503)	Ramping Up, Io.Max		31		Vdc
Turn-Off Input Voltage (-0503)	Ramping Down, Io.Max		30		Vdc
Turn-On Input Voltage (-0302)	Ramping Up, Io.Max		31.2		Vdc
Turn-Off Input Voltage (-0302)	Ramping Down, Io.Max		30.4		Vdc
Turn-On Time	To Output Regulation Band After Remote Control Rise Time		250	400	ms
			25		ms
			5		ms
Input Reflected Ripple Current	Vin.Max, Io.Max			60	mAp-p
Input Capacitance				2	μF

IMS30 Series: 30W DC/DC Converters
32-75V Input
3.3V & 5.1V, 1.8V & 3.3V Dual Outputs

Output Specifications

All specifications apply over input voltage, output load and temperature @ 25°C, unless otherwise noted.

48IMS30-0503-9G: (Vo1) 5.1V/3.1A

Parameter		Conditions/Description	Min	Nom	Max	Units
Output Voltage Setpoint Accuracy	Vo1	Vin.Nom, Io1 = 1.55A, Io2 = 2.1A, 25°C	4.9	5.1	5.3	Vdc
Output Current #	Io1	Vin.Min to Vin.Max	0.6		3.1	Adc
Line Regulation		Vin.Min to Vin.Max, 50% Io.Max		50	100	mV
Load Regulation			See graph (Load/Cross regulation window)			
Cross Regulation						
Dynamic Regulation Peak Deviation		50-100% Io.Max load step change.			250	± mV
Settling Time		to 1% error band			1000	µs
Output Voltage Ripple*	Vr	Vin.Min to Vin.Max, Io.Min to Io Max, 20MHz Bandwidth		50	100	mVp-p
Admissible Load Cap.	Comax	Io.Max, Vin.Nom**			2,200	µF
Output Current Limit Threshold	Icl	Vout <0.90 Vo.Nom, both outputs set to Icl, Vimin	120		180	%Io.Max
Switching Frequency	Fs	Vin.Nom, Io.Max		260		kHz
Temperature Coeff.	Tco				0.02	%Vo/°C

48IMS30-0503-9G: (Vo2) 3.3V/4.2A

Parameter		Conditions/Description	Min	Nom	Max	Units
Output Voltage Setpoint Accuracy	Vo2	Vin.Nom, Io1 = 1.55A, Io2 = 2.1A, 25°C	3.265	3.3	3.335	Vdc
Output Current #	Io2	Vin.Min to Vin.Max	0.6		4.2	Adc
Line Regulation		Vin.Min to Vin.Max, 50% Io.Max			33	mV
Load Regulation		Vin.Nom, Io.Min to Io.Max		35	70	mV
Cross Regulation		Io2 = 4.2A, Io1 Min to Max, measure ΔVo2			33	mV
Dynamic Regulation Peak Deviation		50-100% Io.Max load step change.			200	± mV
Settling Time		to 1% error band			3000	µs
Output Voltage Ripple*	Vr	Vin.Min to Vin.Max, Io.Min to Io Max, 20MHz Bandwidth		50	100	mVp-p
Admissible Load Cap.	Comax	Io.Max, Vin.Nom			2,200	µF
Output Current Limit Threshold	Icl	Vout <0.90 Vo.Nom, both outputs set to Icl, Vi.min	120		180	%Io.Max
Temperature Coeff.	Tco				0.02	%Vo/°C
Trim Range**	Vt	Io.Min to Io.Max, Vin.Min to Vin.Max	2.97		3.63	Vdc

* Measure with a 1µF ceramic across each output to ground, 20MHz bandwidth

** Measured with constant resistive load

*** When Vo2 is trimmed, Vo1 follows linearly

IMS30 Series: 30W DC/DC Converters
32-75V Input
3.3V & 5.1V, 1.8V & 3.3V Dual Outputs

48IMS30-0503-9G Characteristic curves

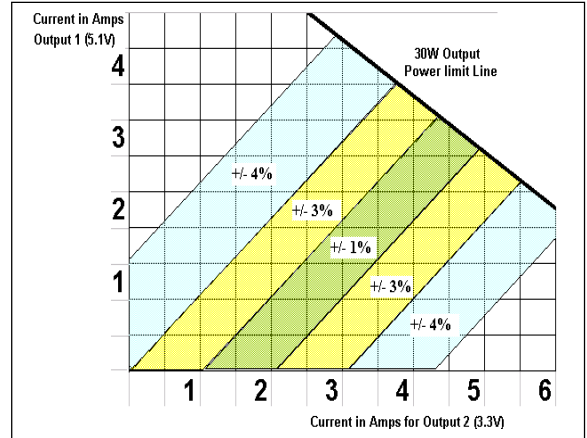
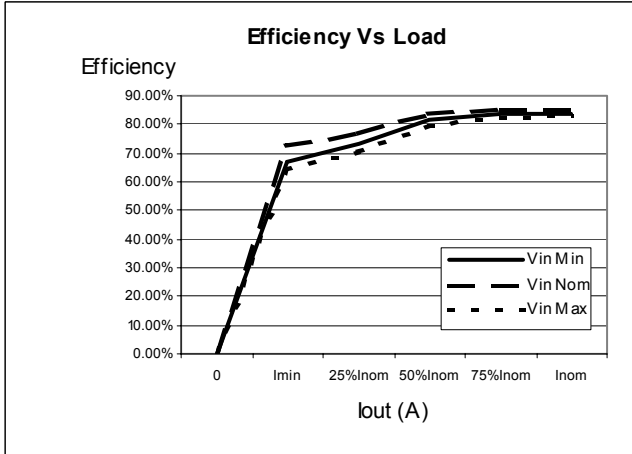

Cross regulation and load regulation window

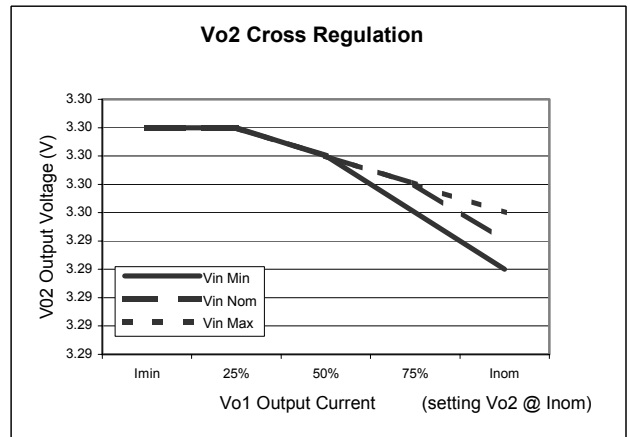
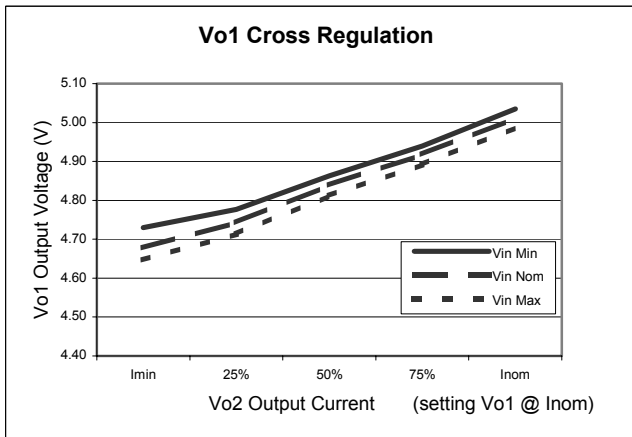
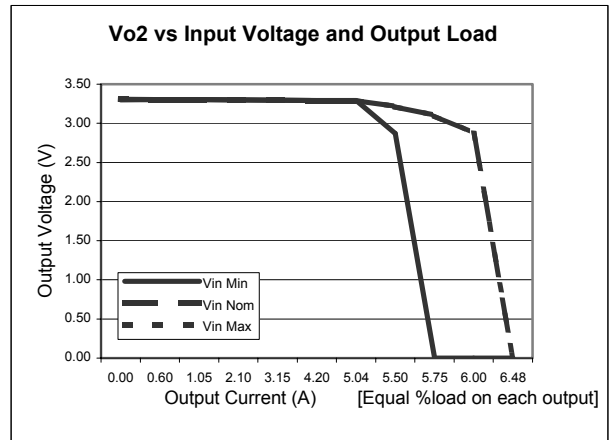
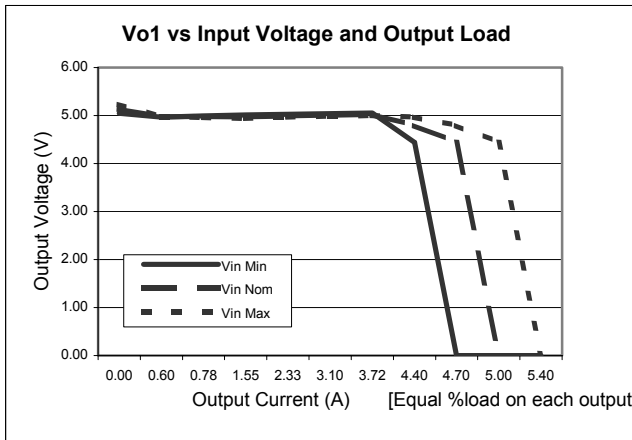

IMS30 Series: 30W DC/DC Converters
32-75V Input
3.3V & 5.1V, 1.8V & 3.3V Dual Outputs

Output Specifications

All specifications apply over input voltage, output load and temperature @ 25°C, unless otherwise noted.

48IMS30-0302-9G: (Vo1) 3.3V/4A

Parameter		Conditions/Description	Min	Nom	Max	Units
Output Voltage Setpoint Accuracy	Vo1	Vin.Nom, Io1 = 2.0A, Io2 = 3.0A, 25°C	3.25	3.3	3.35	Vdc
Output Current	Io1	Vin.Min to Vin.Max	0.4		4.0	Adc
Line Regulation		Vin.Min to Vin.Max, 50% Io.Max			33	mV
Load Regulation			See graph (Load/Cross regulation window)			
Cross Regulation						
Load Regulation		Vin.Nom, Io.Min to Io.Max		140	200	mV
Cross Regulation		Io1 = 4.0A, Io2 Min to Max, measure ΔVo1			250	mV
Dynamic Regulation Peak Deviation		50-100% Io.Max load step change.			200	± mV
Settling Time		to 1% error band			800	μs
Output Voltage Ripple*	Vr	Vin.Min to Vin.Max, Io.Min to Io Max, 20MHz Bandwidth		40	100	mVp-p
Admissible Load Cap.	Comax	Io.Max, Vin.Nom**			2200	μF
Output Current Limit Threshold	Icl	Vout ≤0.90 Vo.Nom, both outputs set to Icl	120		180	%Io.Max
Switching Frequency	Fs	Vin.Nom, Io.Max		350		kHz
Temperature Coeff.	Tco				0.02	%Vo/°C

48IMS30-0302-9G: (Vo2) 1.8V/5A

Parameter		Conditions/Description	Min	Nom	Max	Units
Output Voltage Setpoint Accuracy	Vo2	Vin.Nom, Io1 = 2.0A, Io2 = 3.0A, 25°C	1.775	1.8	1.825	Vdc
Output Current	Io2	Vin.Min to Vin.Max	0.5		5.0	Adc
Line Regulation		Vin.Min to Vin.Max, 50% Io.Max			18	mV
Load Regulation		Vin.Nom, Io.Min to Io.Max		100	150	mV
Cross Regulation		Io2 = 5.0A, Io1 Min to Max, measure ΔVo2			90	mV
Dynamic Regulation Peak Deviation		50-100% Io.Max load step change.			150	± mV
Settling Time		to 1% error band			600	μs
Output Voltage Ripple*	Vr	Vin.Min to Vin.Max, Io.Min to Io Max, 20MHz Bandwidth		30	75	mVp-p
Admissible Load Cap.	Comax	Io.Max, Vin.Nom**			2200	μF
Output Current Limit Threshold	Icl	Vout ≤0.90 Vo.Nom, both outputs set to Icl	120		180	%Io.Max
Temperature Coeff.	Tco				0.02	%Vo/°C
Trim Range***	Vt	Io.Min to Io.Max, Vin.Min to Vin.Max	1.62		1.98	Vdc

* Measure with a 1μF ceramic across each output to ground, 20MHz bandwidth

** Measured with constant resistive load

*** When Vo2 is trimmed, Vo1 follows linearly

IMS30 Series: 30W DC/DC Converters
32-75V Input
3.3V & 5.1V, 1.8V & 3.3V Dual Outputs

48IMS30-0302-9G Characteristic curves

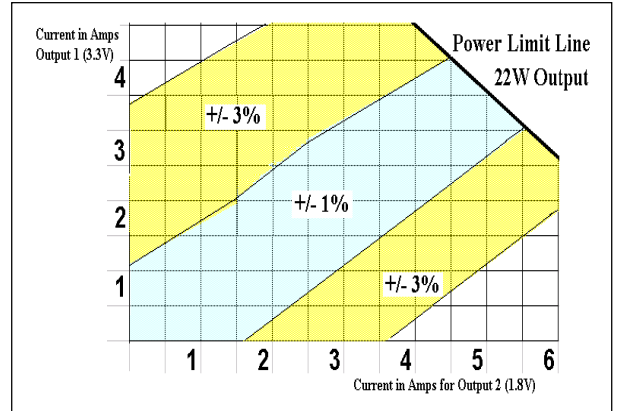
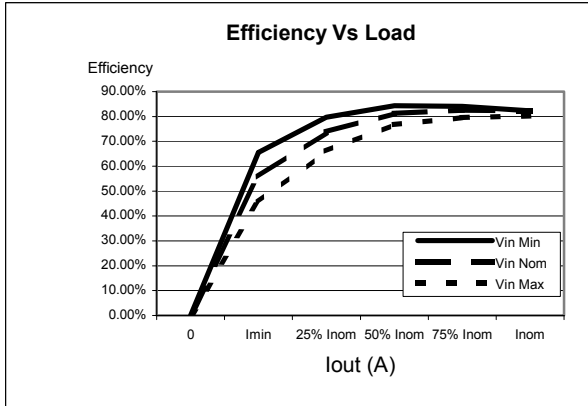

Cross regulation and load regulation window

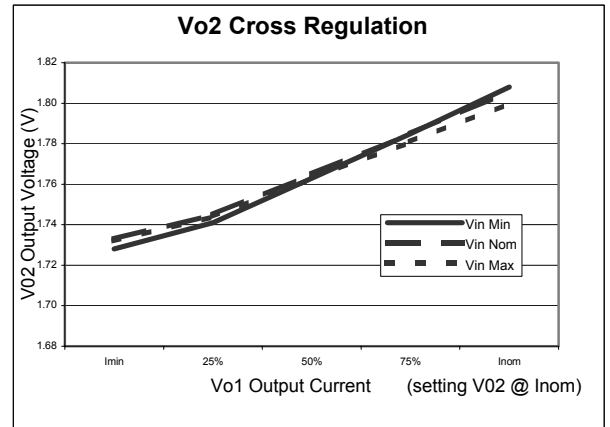
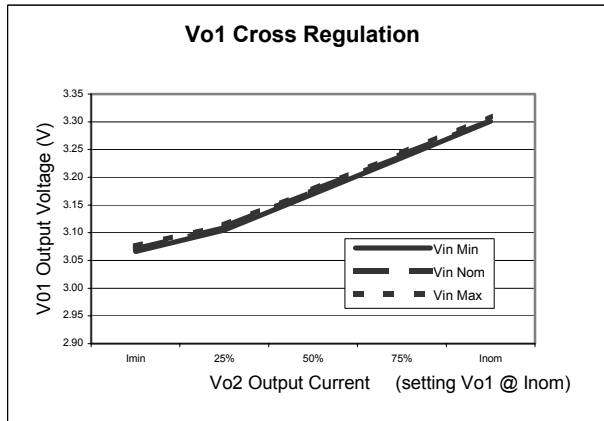
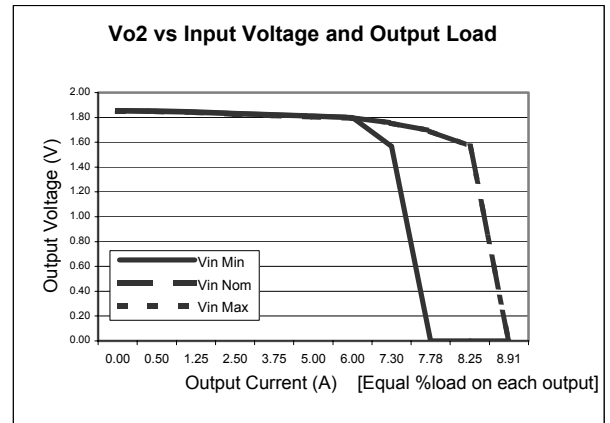
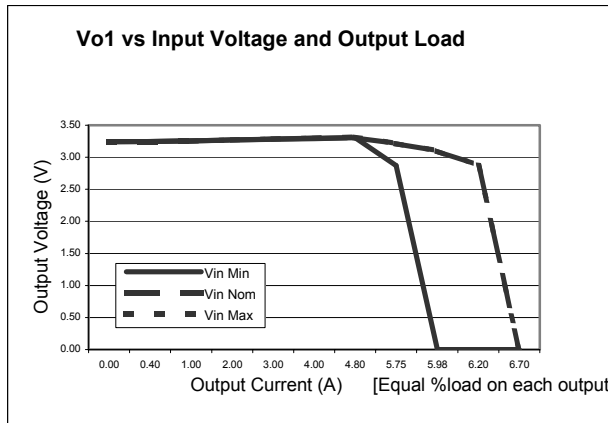

IMS30 Series: 30W DC/DC Converters
32-75V Input
3.3V & 5.1V, 1.8V & 3.3V Dual Outputs

Feature Specifications

All specifications apply over input voltage, output load and temperature range, unless otherwise noted.

Parameter	Conditions/Description	Min	Nom	Max	Units
Shutdown (ON/OFF)					
POSITIVE LOGIC	On/Off signal is low – converter is OFF				
Converter ON	High logic range	2.0		5.0	Vdc
Converter OFF	Shutdown pin is pulled low	-1.0		0.7	Vdc
NEGATIVE LOGIC	On/Off signal is low – converter is ON				
Converter ON	Low logic range	-10		0.8	Vdc
Converter OFF	Shutdown pin is pulled high	2.4		5.0	Vdc

Temperature Derating Curves

The derating curves below give an indication of the output power achievable with and without forced air-cooling. However in the final application, in order to ensure the reliability of the unit, care must be taken to ensure the maximum case temperature is not exceeded under any conditions.

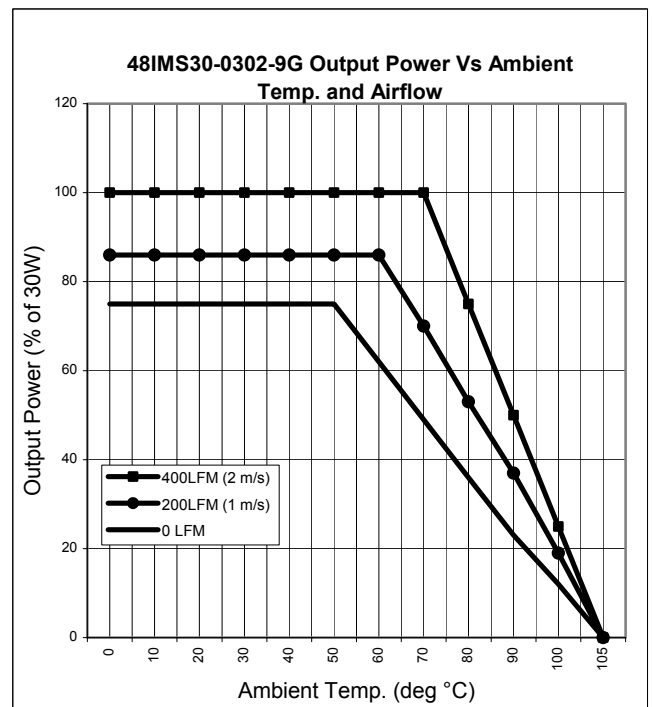
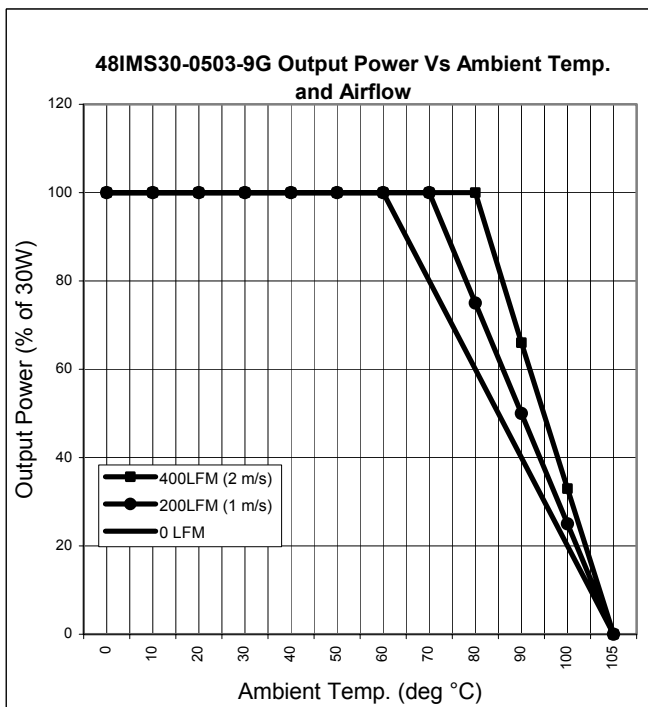

IMS30 Series: 30W DC/DC Converters
32-75V Input
3.3V & 5.1V, 1.8V & 3.3V Dual Outputs

Typical Application

This series of converters does not require any external components for proper operation. However, if the distribution of the input voltage to the converter contains significant inductance, a capacitor across the input terminals may be required to stabilise the input voltage. A minimum of 1 μ F, quality electrolytic / ceramic capacitor is recommended for this purpose.

For output decoupling it is recommended to connect, directly across the output pins, a 1 μ F ceramic capacitor.

Remote Control Features:-

- **Shutdown (Positive Logic)**

The remote control pin functions as a normal soft shutdown. It is referenced to the Vi- pin. With positive logic, when the remote control pin is pulled low, the output is turned off and the unit goes into a very low input power mode.

An open collector switch is recommended to control the voltage between the remote control pin and the Vi- pin of the converter. The remote control pin is pulled up internally, so no external voltage source is required. The user should avoid connecting a resistor between the remote control pin and the Vi+ pin.

The user must take care to ensure that the pin reference for the control is connected close to the Vi- pin. The control signal must not be referenced ahead of EMI filtering, or remotely from the unit. If the remote control pin is not used, it can be left floating.

- **Inhibit (Negative Logic)**

(Option "i" excludes shutdown)

The output(s) of the converter may be enabled or disabled by means of a logic signal (TTL, CMOS, etc.) applied to the inhibit (SD) pin. No output voltage overshoot will occur when the unit is turned on. If the inhibit function is not required the inhibit pin should be connected to Vi- to enable the output (active low logic, fail safe).

Programmable Undervoltage Lockout

The remote control pin (SD) can also be used as a programmable undervoltage lockout. The undervoltage lockout value is 30V with a typical 0.5V hysteresis window, which can be trimmed up by means of an external resistor, connected between the SD pin and Vi- pin.

48IMS30	
Rext [K Ω]	Vi min [V]
∞	31
50	34
29	36
20	38
15	40

Output Current Limiting

When the output is overloaded above the maximum output current rating, the voltage will start to reduce to maintain the output power to a safe level. In a condition of high overload or short-circuit where the output voltage is pulled below approximately 30% of Vo.Nom, the unit will enter a 'Hiccup' mode of operation. Under this condition the unit will attempt to restart, approximately every 100ms until the overload has cleared.

Synchronisation Feature

It is possible to synchronise the switching frequency of one or more converters to an external symmetrical clock signal. Consult factory if this option is required, for full application details.

Short Circuit Behaviour

The current limit characteristic shuts down the converter whenever a short circuit or an overload is applied to its output. The converter self-protects and automatically recovers after removal of the overload condition (hiccup mode).

IMS30 Series: 30W DC/DC Converters
32-75V Input
3.3V & 5.1V, 1.8V & 3.3V Dual Outputs

Output Voltage Trim

The trim feature allows the user to adjust the output voltage from the nominal (+/-10%). This is a secondary referenced control trim. If the control circuit is left open circuit the nominal output voltages appear.

A single external resistor can adjust output voltage. To increase V_{out} , a resistor is connected between Trim pin (#17) and Go pin (#15). To decrease V_{out} , a resistor is connected between Trim pin (#17) and V_{o2} pin (#11). Output V_{o1} linearly follows V_{o2} when trimmed.

To increase V_o :

$$R_{adj} = (C / (V_d - V_o)) - B \quad \Omega$$

Where: V_d = Desired output voltage
 V_o = Nominal output voltage.

To decrease V_o :

$$R_{adj} = [A * (V_d - D) / (V_o - V_d)] - B \quad \Omega$$

Where: V_d = Desired output voltage
 V_o = Nominal output voltage.

Model	A	B	C	D
48IMS30-0503-9G	1800	1800	2229	1.24
48IMS30-0302-9G	450	500	1080	1.24

Note:

When the output voltage is trimmed up, the output power from the converter must not exceed its maximum rating. This is determined by measuring the output voltage on the output pins, and multiplying it by the output current.

Thermal Considerations

The converter is designed for natural or forced convection cooling. The output power of the converter is limited by the maximum case temperature (T_c). To ensure reliable long term operation of the converters, and to comply with safety agency requirements, Power-One limits maximum allowable case temperature (T_c) to 105°C (see Mechanical Drawings).

Overtemperature Protection

The converters are protected from possible overheating by means of an internal non-latching temperature monitoring circuit. It shuts down the unit above the internal temperature limit and attempts to automatically restart in short periods. This feature prevents from excessive internal temperature excursion, which could occur in heavy overload conditions.

Overvoltage Protection

Overvoltage protection is available on the 48IMS30-0503-9G and has a typical inception point 130% of V_{o2} . In the event of an overvoltage, the secondary loop flags the primary side controller and the unit self protects.

Input Transient Voltage Protection

A built-in suppressor diode provides effective protection against transients and high-energy pulses that may occur. This diode also provides for reverse polarity protection at the input by conducting current in the reverse direction.

IMS30 Series: 30W DC/DC Converters
32-75V Input
3.3V & 5.1V, 1.8V & 3.3V Dual Outputs

Safety Considerations

These converters feature 1500 Volt DC isolation from input to output. The input to output resistance is greater than 10M Ω . These converters are provided with basic insulation between input and output circuits according to EN60950 / UL1950 / CSA60950-00. Nevertheless, if the system using the converter needs to receive safety agency approval, certain rules must be followed in the design of the system. In particular, all of the creepage and clearance requirements of the end-use safety requirements must be observed. These documents include UL60950, CSA60950-00 and EN60950, although specific applications may have additional requirements.

In order for the output of the converter to be considered as SELV (Safety Extra Low Voltage) or TNV-1, according to EN60950 / UL1950 / CSA60950-00, one of the following requirements must be met in the system design:

- The converter has no internal fuse. An external fuse must be provided to protect the system from catastrophic failure. A fuse with a rating not greater than 3.15A is recommended. The user can select a lower rating fuse based upon the inrush transient and the maximum input current of the converter, which occurs at the minimum input voltage. Both input traces and the chassis ground trace (if applicable) must be capable of conducting a current of 1.5 times the value of the fuse without opening. The fuse must not be placed in the grounded input line, if any.
- If the voltage source feeding the module is SELV, the output of the converter is considered SELV and may be grounded or ungrounded.
- The circuitry of the converter may generate transients, which exceed the input voltage. Even if the input voltage is SELV (<60V) the components on the primary side of the converter may have to be considered as hazardous. A safety interlock may be needed to prevent the user from accessing the converter while operational.

EMC Specifications

Conducted Noise:

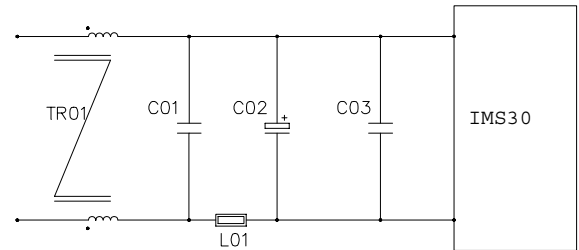

Suggested circuit required for level B of CISPR 22/EN 55022, measured at $U_{j nom}$ and $I_{o nom}$.

Reference Designator	Description	Part Number	Vendor
TR01	80 μ H common mode choke	PD0034	Pulse Engineering
C01	1 μ F ceramic capacitor	18124C105KAT4A	AVX
L01	47 μ H inductor	DS5022P-473	Coilcraft
C02	47 μ F electrolytic capacitor	B41588-D9476-T	Siemens
C03	130nF ceramic capacitor	1206B134M101NT	Novacap

Electromagnetic Susceptibility:

Standard	Applied Stress	Class Level	Performance Outcome *
Electrostatic Discharge EN61000-4-2	2KV to pins	1	B
Electromagnetic Field EN61000-4-3	3V/m	2	A
Electrical Fast Transient EN61000-4-4	2000 Vp to input	3	B
Conducted Disturbances EN61000-4-6	3Vrms to input	2	B

* **A** denotes normal operation, no deviation from specification. **B** denotes temporary deviation from specification is possible.

Mechanical Drawing

Note:- mm[inches]
 Tolerances: -
0.5-10 ±0.1
10-100 ±0.2

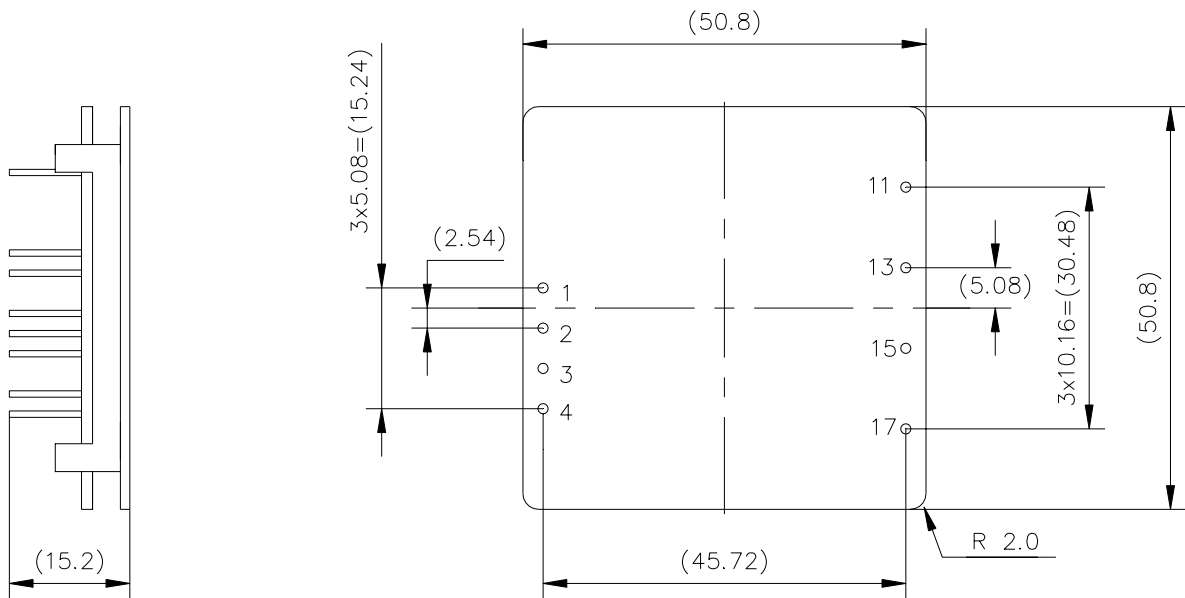

NOTE:
Option P has overall length of 13.2 mm

Bottom View

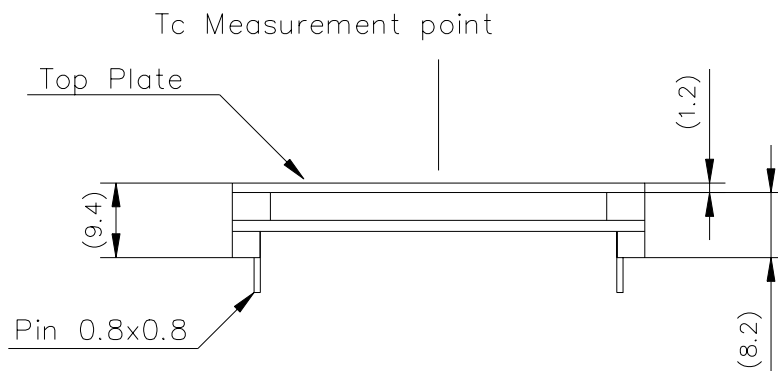

IMS30 Series: 30W DC/DC Converters
32-75V Input
3.3V & 5.1V, 1.8V & 3.3V Dual Outputs

Pin-Out

Pin	Designation	Function	Reference	-K option
1	Vi+	Positive input voltage	Primary	Vi+
2	Vi-	Negative input voltage	Primary	Vi-
3	W	Synchronisation	Primary	No pin
4	SD	Remote Control (shutdown / inhibit / PUL)	Primary	SD
5				
6				
7				
8				
9				
10				
11	Vo2	Output voltage 2	Secondary	Vo2
12				
13	Vo1	Output voltage 1	Secondary	Go
14				
15	Go	Common output return	Secondary	Vo1
16				
17	Trim	Output voltage adjust	Secondary	No Pin

Ordering Information (consult factory for availability)

Options	Suffixes to part number
Negative logic version	Add suffix "i" (example 48IMS30-0503-9Gi)
Alternate pin-out version	Add suffix "K" (example 48IMS30-0503-9GK)
Alternate pin length (13.2 mm)	Add suffix "P" (example 48IMS30-0503-9GP)

Notes

1. Consult factory for the complete list of available options.
2. Power-One products are not authorized for use as critical components in life support systems, equipment used in hazardous environments, or nuclear control systems without the express written consent of the President of Power-One, Inc.
3. Specifications are subject to change without notice.