

15 Watt DC-DC Converters

IMX 15 Series IMY 15 Series

Wide input voltage ranges up to 150 V DC
1 or 2 outputs up to 48 V DC
1500...4000 V DC I/O electric strength test

- Extremely wide input voltage ranges
- Electrical isolation, also between outputs
- Emissions below EN 55022, level B
- Immunity to IEC/EN 61000-4-2,-3,-4,-5 and -6
- High efficiency (typ. 87%)
- Input undervoltage lock-out
- Shut down input, output voltages adjustable
- Flex power: Flexible load distribution on outputs
- Outputs no-load, overload and short-circuit proof
- Operating ambient temperature up to $-40...85^{\circ}\text{C}$
- Thermal protection
- 2" x 1.6" case with 10.5 mm profile
- Supplementary insulation: 20/40 IMX 15 types
- Double or reinforced insulation: 110 IMY 15 types

Safety according to IEC/EN 60950, UL 1950



¹ For 110 IMY 15 types

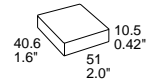

Summary

The IMX 15 and IMY 15 series of board mountable 15 Watt DC-DC converters has been designed according to the latest industry requirements and standards. The converters are particularly suitable for use in mobile or stationary applications in transport, railways, industry, or telecommunication where variable input voltages or high transient voltages are prevalent.

Covering a total input voltage range from 8.4 up to 150 V with 3 different types, the units are available with single, dual and electrically isolated double outputs from 3.3 up to 48 V externally adjustable, with flexible load distribution on dual and double output units. A shut down input allows remote converter on-off. Features include consistently high efficiency over the entire input voltage range, high reliability and excellent dynamic response to load and line changes.

The converters are designed and built according to the international safety standards IEC/EN 60950, UL 1950, CAN/CSA C22.2 No.950-95 and approved / recognized LGA, UL and cUL. The 20 IMX 15 and 40 IMX 15 types provide supplementary insulation. Connected to a secondary circuit the

40 IMX 15 types provide SELV outputs even if the bus voltage at the converter input exceeds the SELV-limit of 60 V DC. The 110 IMY 15 types provide double insulation and are CE marked. They may be connected to e.g. a rectified 110 V AC source without any further isolation barrier.

The circuit comprises of integrated planar magnetics and all components are automatically assembled and solidly soldered onto a single PCB without any wire connection. Magnetic feedback ensures maximum reliability and repeatability in the control loop over all operating conditions. Careful considerations of possible thermal stresses ensure the absence of hot spots providing long life in environments where temperature cycles are a reality. The thermal design allows operation at full load up to an ambient temperature of 71°C in free air without using any potting material. For extremely high vibration environments the case has holes for screw mounting. Various options as e.g. extended temperature range $-40...85^{\circ}\text{C}$ or an alternative pinout provide a high level of application specific engineering and design-in flexibility.

Table of Contents

	Page		Page
Summary	1	Auxiliary Functions	12
Type Survey and Key Data	2	Electromagnetic Compatibility (EMC)	13
Type Key and Product Marking	3	Immunity to Environmental Conditions	15
Functional Description	4	Mechanical Data	16
Electrical Input Data	5	Safety and Installation Instructions	17
Electrical Output Data	7	Description of Option	20

Type Survey and Key Data

Table 1: Type survey

Output 1		Output 2		Output power $P_{o\ nom}$ [W]	Input voltage $U_{i\ min}...U_{i\ max}$ [V DC]	Efficiency η_{typ} [%]	Type designation	Options ²
$U_{o\ nom}$ [V DC]	$I_{o\ nom}^1$ [A]	$U_{o\ nom}$ [V DC]	$I_{o\ nom}^1$ [A]					
3.3	4.5	-	-	14.9	8.4...36	84	20 IMX 15-03-9RG	-8, i, C, L, Z
3.3	4.5	-	-	14.9	16.8...75 ³	85	40 IMX 15-03-9RG	-8, i, C, L, Z
3.3	4.5	-	-	14.9	50...150 ⁴	84	110 IMY 15-08-8RG	i, Z
5.1	3.5	-	-	17.8	8.4...36	88	20 IMX 15-05-9RG	-8, i, C, L, Z
5.1	3.5	-	-	17.8	16.8...75 ³	88	40 IMX 15-05-9RG	-8, i, C, L, Z
5.1	3.5	-	-	17.8	50...150 ⁴	86	110 IMY 15-05-8RG	i, Z
5.1	2.3	-	-	11.7	8.4...36	85	20 IMX 15-05-9R	-8, i, C, L, Z
5.1	2.5	-	-	12.8	16.8...75 ³	83	40 IMX 15-05-9R	-8, i, C, L, Z
5.1	2.5	-	-	12.8	50...150 ⁴	83	110 IMY 15-05-8R	i, Z
12	1.3	-	-	15.6	8.4...36	88	20 IMX 15-12-9C	-8
12	1.3	-	-	15.6	16.8...75 ³	88	40 IMX 15-12-9C	-8
15	1.0	-	-	15	8.4...36	88	20 IMX 15-15-9C	-8
15	1.0	-	-	15	16.8...75 ³	88	40 IMX 15-15-9C	-8
5.1	1.35	3.3	1.35	11.3	8.4...36	84	20 IMX 15-0503-9R	-8, i, L, Z
5.1	1.5	3.3	1.5	12.6	16.8...75 ³	84	40 IMX 15-0503-9R	-8, i, L, Z
5.1	1.5	3.3	1.5	12.6	50...150 ⁴	82	110 IMY 15-0503-8R	i, Z
5	1.3	5	1.3	13.0	8.4...36	86	20 IMX 15-05-05-9	-8, K, i, C, L, Z
5	1.4	5	1.4	14.0	16.8...75 ³	86	40 IMX 15-05-05-9	-8, K, i, C, L, Z
5	1.4	5	1.4	14.0	50...150 ⁴	86	110 IMY 15-05-05-8	i, Z
12	0.65	12	0.65	15.6	8.4...36	88	20 IMX 15-12-12-9	-8, K, i, C, L, Z
12	0.7	12	0.7	16.8	16.8...75 ³	88	40 IMX 15-12-12-9	-8, K, i, C, L, Z
12	0.7	12	0.7	16.8	50...150 ⁴	87	110 IMY 15-12-12-8	i, Z
15	0.5	15	0.5	15.0	8.4...36	88	20 IMX 15-15-15-9	-8, K, i, C, L, Z
15	0.56	15	0.56	16.8	16.8...75 ³	88	40 IMX 15-15-15-9	-8, K, i, C, L, Z
15	0.56	15	0.56	16.8	50...150 ⁴	87	110 IMY 15-15-15-8	i, Z
24	0.32	24	0.32	15.4	8.4...36	86	20 IMX 15-24-24-9	-8, i, L, Z
24	0.35	24	0.35	16.8	16.8...75 ³	86	40 IMX 15-24-24-9	-8, i, L, Z
24	0.35	24	0.35	16.8	50...150 ⁴	86	110 IMY 15-24-24-8	i, Z

¹ Flexible load distribution on dual and double outputs possible up to 75% of the total output power $P_{o\ nom}$ on one of the 2 outputs.

IMX/IMY 15-0503 types have reduced load distribution flexibility; 1.8 A max. on one of the 2 outputs. The other output should not exceed the difference to the total output power $P_{o\ nom}$.

² See: *Description of Options*.

³ Short-time operation down to $U_{i\ min} \geq 14.4$ V possible. P_o reduced to approx. 85% of rated output power.

⁴ Short-time operation down to $U_{i\ min} \geq 43.2$ V possible. P_o reduced to approx. 85% of rated output power.

Type Key and Product Marking

		20	IMX	15	-	05	-	05	-	7	R	G	K	i	C	L	Z
Input voltage range U_i																	
8.4...36 V DC	20																
16.8...75 V DC	40																
50...150 V DC	110																
Series	IMX 15, IMY 15																
Output voltage type output 1	03, 05, 12, 15, 24																
Dash designates double output unit with two independent electrically isolated outputs	- ¹																
Output voltage type output 2	03, 05, 12, 15, 24																
Operating ambient temperature range T_A																	
-40...71°C (standard)	-9																
-40...85°C (option)	-8 ²																
Options and features:																	
R input and magnetic feedback	R ^{2 3}																
Synchronous rectification	G																
Alternative pinout	K ^{2 4}																
Inhibit	i ^{2 5}																
Industrial C-pinout	C																
Surface mount version with PCB lid	L																
Open frame	Z																

¹ Not applicable with option K or -0503- types.

² For lead times contact factory. Some types require a minimum order quantity.

³ Standard features for single output and -0503- types. Excludes option K.

⁴ Option K excludes option R.

⁵ Option inhibit excludes shut down and option K.

Examples: 20 IMX 15-05-05-9: DC-DC converter, input voltage range 8.4...36 V, 2 electrically isolated outputs each providing 5 V, 1.3 A.

110 IMY 15-0503-9R: DC-DC converter, input voltage range 50...150 V, 2 outputs with common return providing +5.1 V, 1.5 A and +3.3 V, 1.5 A. Unit fitted with magnetic feedback for tight output voltage regulation.

Product Marking

Basic type designation, output voltages and currents, applicable safety approval and recognition marks, Power-One patent nos. and company logo. Date code and serial no.

Functional Description

The IMX/IMY 15 series of DC-DC converters are magnetic feed-back controlled flyback converters using current mode PWM (Pulse Width Modulation). The -05- and -0503- output voltage versions as well as all double output versions fitted with option R feature an active magnetic feedback loop via a pulse transformer which results in very tight regulation of the output voltage (see fig.: *Block diagram, single output types, -0503- types and double output types with option R*). The output voltages of these versions can be adjusted via the R input. The R input is referenced to the secondary side and allows for programming of the output voltages in the range of approximately 80 to 105% of $U_{o\ nom}$ using either an external resistor or an external voltage source.

The voltage regulation on the dual and double output versions without option R is achieved with a passive transformer feedback from the main transformer (see fig.: *Block*

diagram, for double output types). The output voltages can be adjusted via the Trim input. The Trim input is referenced to the primary side of the converter and allows for programming of the output voltages in the range 100 to 105% of $U_{o\ nom}$ by an external resistor or within 75 to 105% using an external voltage source. The load regulation output characteristic allows for paralleling of one or several double output units with equal output voltages.

Current limitation is provided by the primary circuit, thus limiting the total output power of double output types. The shut down input allows remote converter on/off.

Overtemperature protection will shut down the unit in excessive overload conditions with automatic restart approximately every 50 to 60 ms.

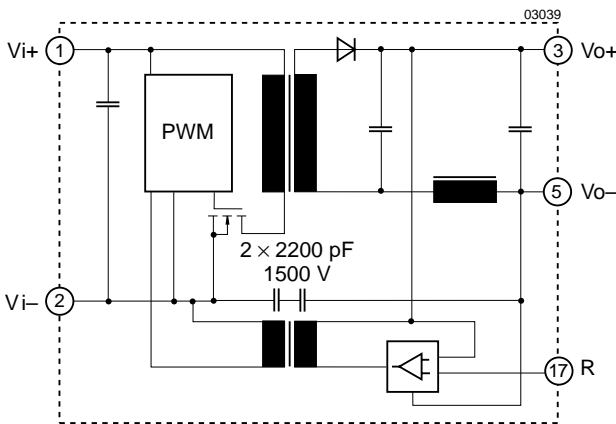

Fig. 1
Block diagram, single output types

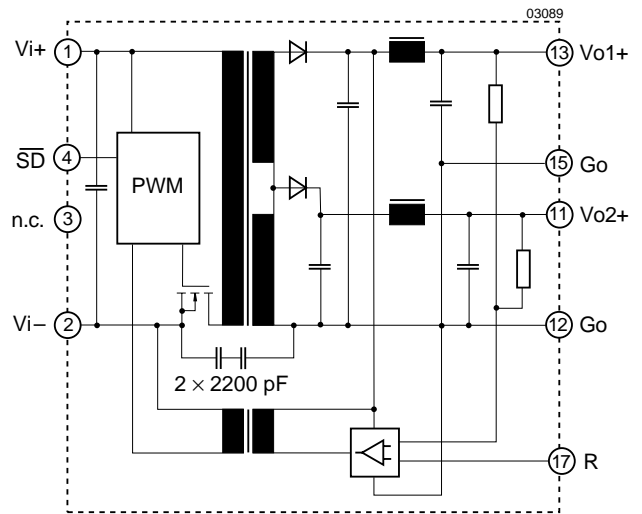

Fig. 3
Block diagram, -0503- types.

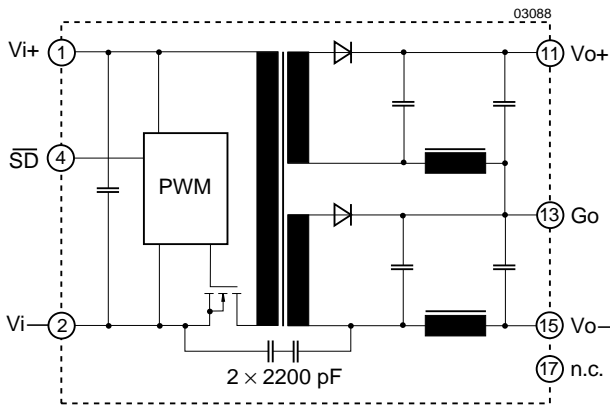

Fig. 2
Block diagram, dual output types, alternative K-pinout.

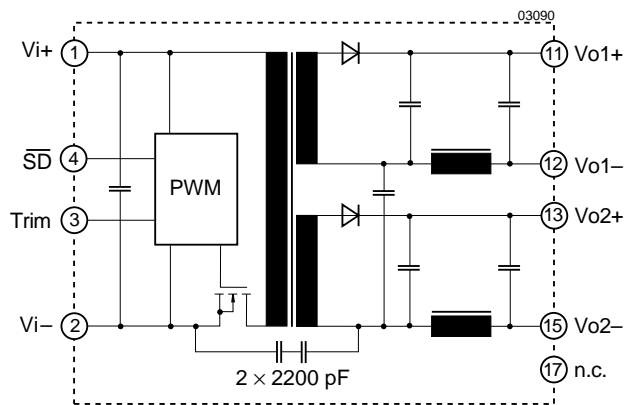

Fig. 4
Block diagram, double output types, standard pinout.

Electrical Input Data

General conditions:

- $T_A = 25^\circ\text{C}$, unless T_C is specified.
- Shut down pin left open-circuit.
- Trim or R input left open-circuit.

Table 2: Input Data

Input			20 IMX			40 IMX			110 IMY			Unit			
Characteristics		Conditions	min	typ	max	min	typ	max	min	typ	max				
U_i	Input voltage range ¹		$T_{A \text{ min}} \dots T_{A \text{ max}}$			8.4 ⁵	36		16.8 ^{5 6}	75		50 ^{5 7}	150		V DC
$U_{i \text{ nom}}$	Nominal input voltage		$I_o = 0 \dots I_{o \text{ nom}}$			20			40			110			
$U_{i \text{ sur}}$	Repetitive surge voltage		Abs. max input (3 s)			40			⁹	100		168			
$t_{\text{start up}}$	Converter start-up time ²	Switch on	Worst case condition at $U_{i \text{ min}}$ and full load			0.25	0.5		0.25	0.5		0.25	0.5		s
		$\overline{\text{SD}}$ high				0.1			0.1			0.1			
t_{rise}	Rise time ²		$U_{i \text{ nom}}$ resistive load			5			5			5			ms
			$I_o \text{ nom}$ capac. load			10	20		10	20		10	20		
$I_{i \text{ o}}$	No load input current		$I_o = 0, U_{i \text{ min}} \dots U_{i \text{ max}}$			40			20			10			mA
I_{rr}	Reflected ripple current		$I_o = 0 \dots I_{o \text{ nom}}$			30			30			20			mA _{pp}
$I_{\text{inr p}}$	Inrush peak current ³		$U_i = U_{i \text{ nom}}$			8			9			10			A
C_i	Input capacitance		for surge calculation			1.5			0.75			0.35			μF
$U_{\overline{\text{SD}}}$	Shut down voltage		Unit shut down			-10...0.7			-10...0.7			-10...0.7			V DC
			Unit operating			open or 2...20			open or 2...20			open or 2...20			
$R_{\overline{\text{SD}}}$	Shut down input resistance		For current calculations			approx. 10			approx. 10			approx. 10			kΩ
$I_{\overline{\text{SD}}}$	Input current if unit shut down		$U_{i \text{ min}} \dots U_{i \text{ max}}$			6			3			1			mA
f_s	Switching frequency		$U_{i \text{ min}} \dots U_{i \text{ max}}, I_o = 0 \dots I_{o \text{ nom}}$			approx. 300			approx. 300			approx. 300			kHz
$U_{i \text{ RFI}}$	Input RFI level conducted		EN 55022 ⁴			B ⁸			B			B			

¹ $U_{i \text{ min}}$ will not be as stated if U_o is increased above $U_{o \text{ nom}}$ by use of the R or the Trin input. If the output voltage is set to a higher value, $U_{i \text{ min}}$ will be proportionately increased.

² Measured with resistive and max. admissible capacitive load.

³ Source impedance according to prETS 300132-2, version 4.3.

⁴ Measured with a lead length of 0.1 m, leads twisted. Double output units with both outputs in parallel.

⁵ Input undervoltage lock-out at typ. 80% of $U_{i \text{ min}}$.

⁶ Short time operation down to $U_{i \text{ min}} > 14.4$ V possible. P_o reduced to approx. 85% of $P_{o \text{ nom}}$.

⁷ Short time operation down to $U_{i \text{ min}} > 43.2$ V possible. P_o reduced to approx. 85% of $P_{o \text{ nom}}$.

⁸ 20 IMX 15 types require 4.7 μF/50 V capacitance across the input (Polyester, Philips 372 series).

⁹ See: *Transient ETR 283 (19Pfl1), Electromagnetic Immunity*.

Inrush current

The inrush current has been kept as low as possible by choosing a very small input capacitance. A series resistor may be installed in the input line to further reduce this current.

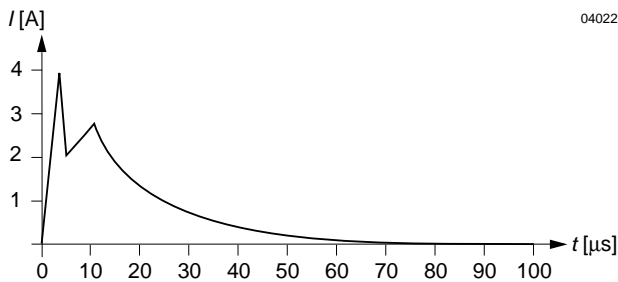

04022

Fig. 6
Typical inrush current at $U_{i\text{ nom}}$, $P_{o\text{ nom}}$ versus time (40 IMX 15). Source impedance according to ETS 300132-2 at $U_{i\text{ nom}}$.

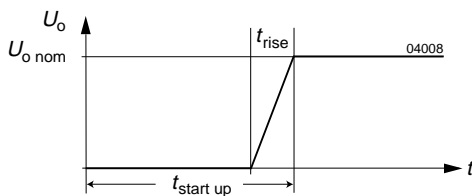

Fig. 7
Converter start-up and rise time

Input Undervoltage Lockout

A special feature of these units is the accurate undervoltage lockout protection which protects the units (and system) from large currents caused by operation at low voltages. This ensures easier start-up in distributed power systems.

Table 3: Turn on and turn off voltage

Type	Turn On	Turn Off	Units
20 IMX	7.5...8	7...7.5	V
40 IMX	12.5...13.5	12...13	
110 IMY	40...42.5	38...40.5	

Reverse Polarity Protection

The built-in suppressor diode also provides for reverse polarity protection at the input by conducting current in the reverse direction. An external fuse is required to limit this current.

Table 4: Recommended external fuses

Converter type	Fuse type
20 IMX 15	F4.0A
40 IMX 15	F2.0A
110 IMY 15	F1.0A

Input Transient Voltage Protection

A built-in suppressor diode provides effective protection against input transients which may be caused for example by short-circuits across the input lines where the network inductance may cause high energy pulses.

Table 5: Built-in transient voltage suppressor

Type	Breakdown voltage $V_{Br\text{ nom}}$ [V]	Peak power at 1 ms P_p [W]	Peak pulse current I_{pp} [A]
20 IMX 15	40	1500	22
40 IMX 15	100	1500	9.7
110 IMY 15	168	600	0.5

For very high energy transients as for example to achieve IEC/EN 61000-4-5 or ETR 283 (19 Pfl1) compliance (as per table: *Electromagnetic Immunity*) an external inductor and capacitor are required. The components should have similar characteristics as listed in table: *Components for external circuitry for IEC/EN 61000-4-5, level 2 or ETR 283 (19Pfl1) compliance.*

Note: The suppressor diode D is only necessary for 20 IMX 15 types.

Table 6: Components for external circuitry for IEC/EN 61000-4-5, level 2 or ETR 283 (19Pfl1) compliance.

Type	Inductor (L)	Capacitor (C)	Diode (D)
20 IMX	68 μ H, 2.7 A	330 μ F, 63 V	1.5 k E47A
40 IMX	220 μ H, 1.3 A	2 \times 100 μ F, 100 V	-
110 IMY	330 μ H, 0.43 A	2 \times 100 μ F, 200 V	-

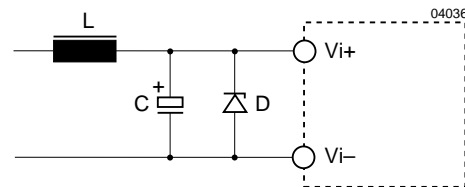

Fig. 8
Example for external circuitry to comply with IEC/EN 61000-4-5 or ETR 283 (19Pfl1); the suppressor diode D is only necessary for 20 IMX 15 types.

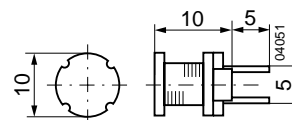

Fig. 9
Dimensions of inductor L for 110 IMY 15 types (e.g. TOKO 494LYF-0098K).

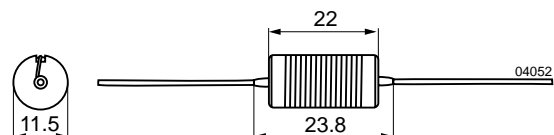

Fig. 10
Dimensions of inductor L for 20 IMX 15 and 40 IMX 15 types (e.g. Coil Craft, PCH-45 series).

Electrical Output Data

General conditions:

- $T_A = 25^\circ\text{C}$, unless T_C is specified
- Shutdown pin left open circuit (not connected)
- R input not connected

Table 7a: Output data for single output units and -0503- types.

Output			3.3 V (RG)			5.1 V (RG)			Unit
Characteristics	Conditions		min	typ	max	min	typ	max	
U_{o1} U_{o2}	Output voltage		$U_{i \text{ nom}}$ $I_o = 0.5 I_{o \text{ nom}}$			$U_{i \text{ nom}}$ $I_o = 0.5 I_{o \text{ nom}}$			V DC
$I_{o \text{ nom}}$	Output current ¹		$U_{i \text{ min}} \dots U_{i \text{ max}}$			$U_{i \text{ min}} \dots U_{i \text{ max}}$			A
	20 IMX 40 IMX/110 IMY								
I_{o1L}	Current limit ²		$U_{i \text{ nom}}, T_C = 25^\circ\text{C}$ $U_{o1} = 93\% U_{\text{nom}}$			$U_{i \text{ nom}}, T_C = 25^\circ\text{C}$ $U_{o1} = 93\% U_{\text{nom}}$			
ΔU_o	Line/load regulation		$U_{i \text{ min}} \dots U_{i \text{ max}}$ $I_o = (0.01 \dots 1) I_{o \text{ nom}}$			$U_{i \text{ min}} \dots U_{i \text{ max}}$ $I_o = (0.01 \dots 1) I_{o \text{ nom}}$			%
$u_{o1/2}$	Output voltage noise		$U_{i \text{ min}} \dots U_{i \text{ max}}$ $I_o = I_{o \text{ nom}}$			$U_{i \text{ min}} \dots U_{i \text{ max}}$ $I_o = I_{o \text{ nom}}$			mV _{pp}
			4			5			
U_{oL}	Output overvoltage limit. ⁶		115			115			%
$C_{o \text{ ext}}$	Admissible capacitive load		4000			4000			μF
$u_{o \text{ d}}$	Dynamic load regulation	Voltage deviat.	$U_{i \text{ nom}}$ $I_{o \text{ nom}} \leftrightarrow 1/2 I_{o \text{ nom}}$ IEC/EN 61204			$U_{i \text{ nom}}$ $I_{o \text{ nom}} \leftrightarrow 1/2 I_{o \text{ nom}}$ IEC/EN 61204			mV
t_d		Recovery time	1			1			ms
α_{U_o}	Temperature coefficient $\Delta U_o / \Delta T_C$		$U_{i \text{ min}} \dots U_{i \text{ max}}$ $I_o = 0 \dots I_{o \text{ max}}$			$U_{i \text{ min}} \dots U_{i \text{ max}}$ $I_o = 0 \dots I_{o \text{ max}}$			%/K

¹ Flexible load distribution: 20 IMX 15-0503-7; 1.6 A max. and 40 IMX 15/110 IMY 15-0503-7 types; 1.8 A max. on one of the 2 outputs, the other output should not be loaded such that the total output power exceeds $P_{o \text{ nom}}$ according to table: *Type survey*.

² The current limit is primary side controlled. In the event of a sustained overload condition the thermal protection may cause the unit to shutdown (restart on cool-down).

³ For -0503- types: total capacitance, of both outputs.

⁴ BW = 20 MHz

⁵ Measured with a probe according to EN 61204

⁶ The overvoltage protection is via a primary side second regulation loop. It is not tracking with R control

Table 7b: Output data for single output units and -0503- types.

Output			5.1 V			5.1/3.3 V			Unit
Characteristics	Conditions		min	typ	max	min	typ	max	
U_{o1} U_{o2}	Output voltage	$U_{i \text{ nom}}$ $I_o = 0.5 I_{o \text{ nom}}$	5.05		5.15	5.0 3.13		5.12 3.46	V DC
$I_{o \text{ nom}}$	Output current ¹	20 IMX 40 IMX/110 IMY	$U_{i \text{ min}} \dots U_{i \text{ max}}$			2 × 1.35			A
			2.3			2 × 1.5			
I_{o1L} I_{o2L}	Current limit ^{2, 4}	20 IMX	$U_{i \text{ nom}}, T_C = 25^\circ\text{C}$			2.7			
				$U_{o1} - 93\% U_{\text{nom}}$			3.8		
I_{o1L} I_{o2L}		40 IMX/110 IMY	3.2			2.9			
			3.6			4.0			
ΔU_o	Line/load regulation		$U_{i \text{ min}} \dots U_{i \text{ max}},$ $I_o = (0.01 \dots 1) I_{o \text{ nom}}$			±0.5			%
			$U_{i \text{ nom}}$			+3, -5			
			$I_o = (0.1 \dots 1) I_{o \text{ nom}}$			±4.5			
$u_{o1/2}$	Output voltage noise		$U_{i \text{ min}} \dots U_{i \text{ max}}$ ⁵			80			mV _{pp}
			$I_o = I_{o \text{ nom}}$ ⁶			40			
U_{oL}	Output overvoltage limit. ⁷		115		130	115		130	%
$C_{o \text{ ext}}$	Admissible capacitive load		4000			total: 4000 ³			μF
$u_{o \text{ d}}$	Dynamic load regulation	Voltage deviat.	$U_{i \text{ nom}}$			±250			mV
t_d		Recovery time	$I_{o \text{ nom}} \leftrightarrow 1/2 I_{o \text{ nom}}$ IEC/EN 61204			1			ms
α_{U_o}	Temperature coefficient $\Delta U_o / \Delta T_C$		$U_{i \text{ min}} \dots U_{i \text{ max}}$ $I_o = 0 \dots I_{o \text{ max}}$			±0.02			%/K

¹ Flexible load distribution: 20 IMX 15-0503-7; 1.6 A max. and 40 IMX 15/110 IMY 15-0503-7 types; 1.8 A max. on one of the 2 outputs, the other output should not be loaded such that the total output power exceeds $P_{o \text{ nom}}$ according to table: *Type survey*.

² The current limit is primary side controlled. In the event of a sustained overload condition the thermal protection may cause the unit to shutdown (restart on cool-down).

³ For -0503- types: total capacitance, of both outputs.

⁴ For -0503- types: Conditions for specified output. Other output loaded with constant current $I_o = 0.5 I_{o \text{ nom}}$.

⁵ BW = 20 MHz

⁶ Measured with a probe according to EN 61204

⁷ The overvoltage protection is via a primary side second regulation loop. It is not tracking with R control

Table 7c: Output data for dual and double output units.

Output			2 × 5 V		2 × 12 V		2 × 15 V		2 × 24 V		Unit
Characteristics		Conditions	min	typ	max	min	typ	max	min	typ	
U_{o1} U_{o2}	Output voltage	$U_{i\text{ nom}}$ $I_o = 0.5 I_{o\text{ nom}}$	4.95	5.05	11.90	12.10	14.88	15.12	23.80	24.20	V DC
$I_{o\text{ nom}}$	Output current ¹	$U_{i\text{ min}} \dots U_{i\text{ max}}$	2 × 1.3		2 × 0.65		2 × 0.50		2 × 0.32		A
	20 IMX 40 IMX/110 IMY		2 × 1.4		2 × 0.70		2 × 0.56		2 × 0.35		
I_{oL}	Current limit ^{2, 4}	$U_{i\text{ nom}}, T_C = 25^\circ\text{C}$ $U_o = 93\% U_{o\text{ nom}}$	3.0		1.6		1.3		0.85		
	20 IMX 40 IMX/110 IMY		3.2		1.7		1.4		0.90		
ΔU_{o1} ΔU_{o2}	Line/load regulation	U_{o1} U_{o2} $U_{i\text{ min}} \dots U_{i\text{ max}}, I_{o\text{ nom}}$ $U_{i\text{ nom}}$ $I_o = (0.1 \dots 1) I_{o\text{ nom}}$	±1		±1		±1		±1		%
			±3		±3		±3		±3		
$u_{o1/2}$	Output voltage noise	$U_{i\text{ min}} \dots U_{i\text{ max}}$ ⁵ $I_o = I_{o\text{ nom}}$ ⁶	80		120		150		240		mV _{pp}
			40		60		70		120		
U_{oL}	Output overvoltage limit. ⁷	Min. load 1%	115	130	115	130	115	130	115	130	%
$C_{o\text{ ext}}$	Admissible capacitive load ³		4000		680		470		180		μF
$u_{o\text{ d}}$	Dynamic load regulation	Voltage deviat.	±250		±300		±300		±600		mV
t_d		Recovery time	1		1		1		1		ms
α_{U_o}	Temperature coefficient $\Delta U_o / \Delta T_C$	$U_{i\text{ min}} \dots U_{i\text{ max}}$ $I_o = 0 \dots I_{o\text{ max}}$	±0.02		±0.02		±0.02		±0.02		%/K

¹ Flexible load distribution: With double or dual output units each output is capable of delivering 75% of the total output power.

The other output should not be loaded such that the total output power exceeds $P_{o\text{ nom}}$ according to table: *Type survey*.

² The current limit is primary side controlled. In the event of a sustained overload condition the thermal protection may cause the unit to shutdown (restart on cool-down).

³ Measured with both outputs connected in parallel.

⁴ Conditions for specified output. Other output loaded with constant current $I_o = 0.5 I_{o\text{ nom}}$.

⁵ BW = 20 MHz

⁶ Measured with a probe according to EN 61204

⁷ The overvoltage protection is via a primary side second regulation loop, not tracking with Trim control.

⁸ Minimum load of 10% on output 1 recommended to prevent the two output voltages to drop in unbalanced load conditions.

Thermal Considerations

If a converter, mounted on a PCB, is located in free, quasi-stationary air (convection cooling) at the indicated maximum ambient temperature $T_{A \max}$ (see table: *Temperature specifications*) and is operated at its nominal input voltage and output power, the case temperature T_C measured at the *Measuring point of case temperature T_C* (see: *Mechanical Data*) will approach the indicated value $T_{C \max}$ after the warm-up phase. However, the relationship between T_A and T_C depends heavily on the conditions of operation and integration into a system. The thermal conditions are influenced by input voltage, output current, airflow, temperature of surrounding components and surfaces and the properties of the printed circuit board. $T_{A \max}$ is therefore only an indicative value and under practical operating conditions, the ambient temperature T_A may be higher or lower than this value.

Caution: The case temperature T_C measured at the: *Measuring point of case temperature T_C* (see: *Mechanical Data*) may under no circumstances exceed the specified maximum value. The installer must ensure that under all operating conditions T_C remains within the limits stated in the table: *Temperature specifications*.

Output Overvoltage Protection

The output of single output units as well as -0503- and -05-05- types are protected against overvoltages by a second control loop. In the event of an overvoltage on one of the outputs the unit will shut down and attempt to restart approximately every 50 to 60 ms. Double and dual output units (with exception of the -0503- and -05-05- types) are protected against overvoltages by a Zener diode across the second output. Under worst case conditions the Zener diode will short circuit. Since with double output units both

Typical Performance Curves

General conditions:

- $T_A = 25^\circ\text{C}$, unless T_C is specified.
- Shut down pin left open circuit.
- Trim or R input not connected.



Fig. 11
 U_o versus I_o (typ) of units with $U_o = 5.1$ V.
(110 IMY 15-05-7R)

outputs track each other the protection diode is only provided in one of the outputs. The main purpose of this feature is to protect against possible overvoltages which could occur due to a failure in the feedback control circuit. The output overvoltage protection is not designed to withstand externally applied overvoltages.

Overtemperature Protection

The converters are protected from possible overheating by means of an internal temperature monitoring circuit. It shuts down the unit above the internal temperature limit and attempts to automatically restart every 50 to 60 ms. This feature prevents from excessive internal temperature building up which could occur in heavy overload conditions.

Short Circuit Behaviour

The current limit characteristic shuts down the converter whenever a short circuit is applied to its output. It acts self-protecting and automatically recovers after removal of the overload condition (hiccup mode).

Connection in Series

The outputs of one or several single or double output units can be connected in series without any precautions, taking into consideration that the highest output voltage should remain below 42 V to ensure that the output remains SELV.

Connection in Parallel

Double outputs of the same converter with equal output voltage (e.g. 5V / 5V) can be put in parallel and will share their output currents almost equally. Parallel operation of single or double outputs of two or more converters with the same output voltage may cause start-up problems at initial start-up. This is only advisable in applications where one converter is able to deliver the full load current as e.g. required in true redundant systems.

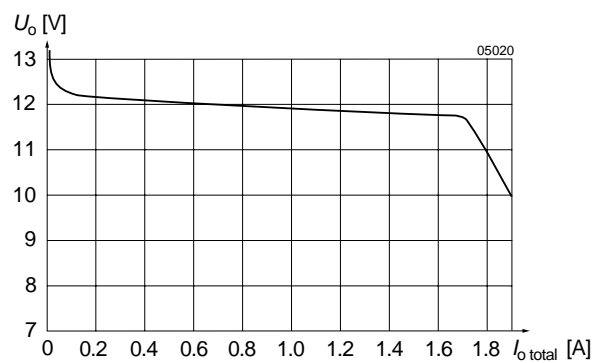

Fig. 12
 U_o versus I_o (typ) of double output units (2×12 V), with both outputs in parallel. (110 IMY 15-12-12-7)

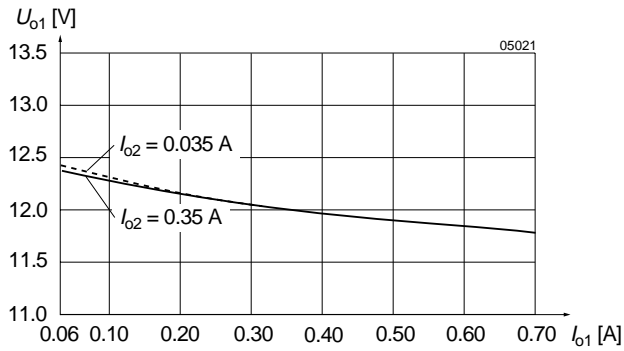

Fig. 13
Cross load regulation U_{o1} versus I_{o1} (typ) for various I_{o2} (2×12 V).

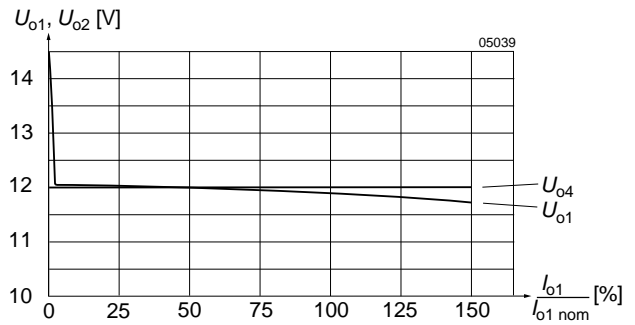

Fig. 16
Flexible load distribution on double outputs (2×12 V) with load variation from 0...150% of $P_{o1 \text{ nom}}$ on output 1. Output 2 loaded with 50% of $P_{o2 \text{ nom}}$.

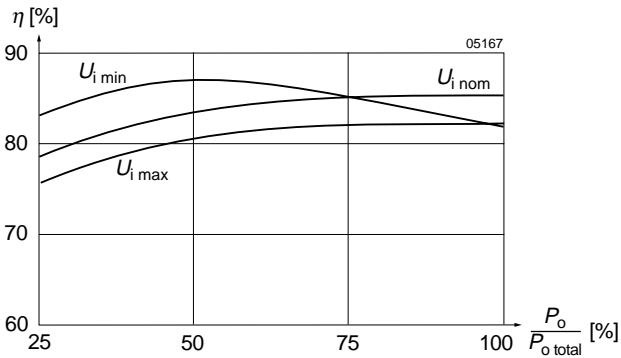

Fig. 14
Efficiency versus input voltage and load. Typical values 40 IMX 15-12-12-7

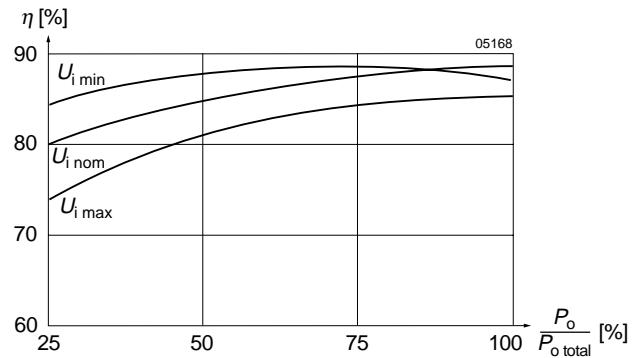

Fig. 17
Efficiency versus input voltage and load. Typical values 110 IMY 15-12-12-7

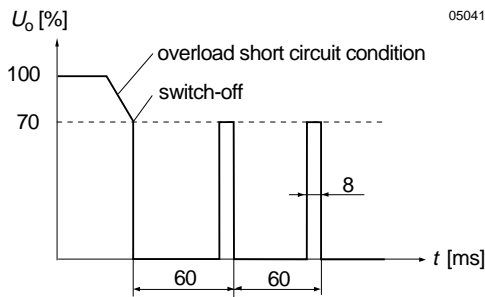

Fig. 15
Overload switch off (hiccup mode), typical values.

Auxiliary Functions

Shut Down Function

The outputs of the converters may be enabled or disabled by means of a logic signal (TTL, CMOS, etc.) applied to the shut down pin. If the shut down function is not required then it should be left open-circuit.

Converter operating: 2.0...20 V
 Converter shut down: -10...0.7 V

Adjustable Output Voltage

- R input for single output units using synchronous rectification (G)
- R input for single output units and -0503- types
- Trim input for double output units

As a standard feature, the single and double output units offer adjustable output voltage(s) by using the control input R or Trim. If the control input is left open-circuit the output voltage is set to $U_o \text{ nom}$. For output voltages $U_o > U_o \text{ nom}$, the minimum input voltage $U_{i \text{ min}}$ (see: *Electrical Input Data*) increases proportionally to $U_o/U_o \text{ nom}$.

Single output units using synchronous rectification (G):

The R input is referenced to the secondary side of the converter. Adjustment of the output voltage is possible by means of an external resistor connected between the R pin and either Vo+ or Vo-.

Note: For the units with synchronous rectification U_o adjustment is different from the standard single output units and -0503- types.

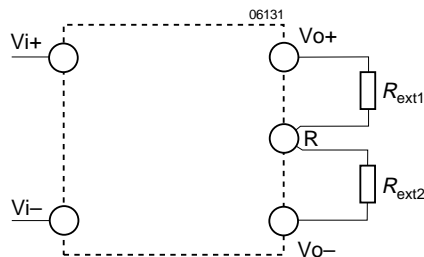

Fig. 18 Output voltage control for single output units synchronous rectification.

Table 8: U_o versus U_{ext} approximate values

$U_o \text{ nom}$ [V]	Typ. values of R_{ext1}		Typ. values of R_{ext2}	
	U_o [% of $U_o \text{ nom}$]	R_{ext1} [kΩ]	U_o [% of $U_o \text{ nom}$]	R_{ext2} [kΩ]
3.3	90	0.47	100	∞
	95	2.7	105	15
	100	∞	110	6.8
5.1	90	3.3	100	∞
	95	8.2	105	9.1
	100	∞	110	3.9-

Single output units and -0503- types fitted with option R:

The R input is referenced to the secondary side of the converter. Adjustment of the output voltage is possible by means of either an external resistor or a voltage source.

a) Adjustment by means of an external resistor R_{ext} .

Depending upon the value of the required output voltage, the resistor shall be connected.

either: Between the R pin and Vo- to achieve an output voltage adjustment range of approximately

$$U_o = 80...100\% U_o \text{ nom.}$$

$$R_{\text{ext1}} \approx 4 \text{ k}\Omega \cdot \frac{U_o}{U_o \text{ nom} - U_o}$$

or: Between the R pin and Vo+ to achieve an output voltage range of approximately $U_o = 100...105\% U_o \text{ nom}$.

$$R_{\text{ext2}} \approx 4 \text{ k}\Omega \cdot \frac{(U_o - 2.5\text{V})}{2.5 \text{ V} \cdot (U_o/U_o \text{ nom} - 1)}$$

b) Adjustment by means of an external voltage U_{ext} between Vo- and R pins.

The control voltage range is 1.96...2.62 V and allows for an adjustment in the range of approximately 80...105% of $U_o \text{ nom}$.

$$U_{\text{ext}} \approx \frac{U_o \cdot 2.5 \text{ V}}{U_o \text{ nom}}$$

Attempting to adjust the output below this range will cause the converter to shut down (hiccup mode).

Note: Applying an external control voltage $>2.75 \text{ V}$ may damage the converter.

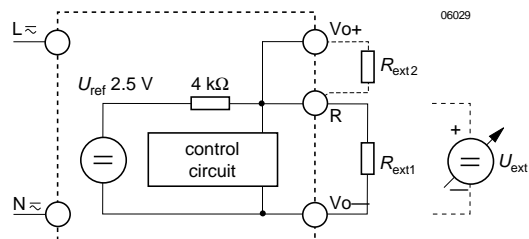

Fig. 19 Output voltage control for single output units, -0503- types and double output units fitted with option R by means of the R input.

Double output units with Trim input:

The Trim input is referenced to the primary side. The figure below shows the circuit topology. Adjustment of the output voltage is possible by means of either an external resistor R_{ext} in the range of 100...105% of $U_o \text{ nom}$ or an external voltage source in the range of 75...105% of $U_o \text{ nom}$.

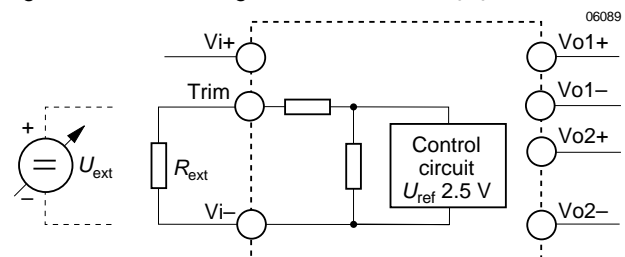

Fig. 20 Output voltage control for double output units by means of the Trim input.

a) Adjustment by means of an external resistor R_{ext} :

Programming of the output voltage by means of an external resistor R_{ext} is possible within a limited range of 100...105% of $U_{o\ nom}$. R_{ext} should be connected between the Trim pin and Vi-. Connection of R_{ext} to Vi+ may damage the converter. The following table indicates suitable resistor values for typical output voltages under nominal conditions ($U_{i\ nom}$, $I_o = 0.5 I_{o\ nom}$), with either paralleled outputs or equal load conditions on each outputs.

Table 9a: R_{ext1} for $U_o > U_{o\ nom}$;
approximate values ($U_{i\ nom}$, $I_{o1,2} = 0.5 I_{o1/2\ nom}$)

U_o [% $U_{o\ nom}$]	R_{ext} [k Ω]
105...108 (107 typically)	0
105	1.5
104	5.6
103	12
102	27
101	68
100	∞

b) Adjustment by means of an external voltage source U_{ext} .

For external output voltage programming in the range 75...105% of $U_{o\ nom}$ a (0...20 V) source U_{ext} is required, connected to the Trim pin and Vi-. The table below indicates typical U_o versus U_{ext} values under nominal conditions ($U_{i\ nom}$, $I_o = 0.5 I_{o\ nom}$), with either paralleled outputs or equal load conditions on each output. Applying a control voltage >20 V will set the converter into a hiccup mode. Direct paralleling of the Trim pins of units connected in parallel is feasible.

Table 9b: U_o versus U_{ext} for $U_o = 75...105\% U_{o\ nom}$;
typical values ($U_{i\ nom}$, $I_{o1/2} = 0.5 I_{o1/2\ nom}$)

U_o [% $U_{o\ nom}$]	U_{ext} [V]
≥ 105	0
102	1.6
95	4.5
85	9
75	13

Electromagnetic Compatibility (EMC)

A suppressor diode together with an input filter forms an effective protection against high input transient voltages

which typically occur in many installations, but especially in battery driven mobile applications.

Electromagnetic Immunity

Table 10: Immunity type tests

Phenomenon	Standard ¹	Class Level	Coupling mode ²	Value applied	Waveform	Source Imped.	Test procedure	In oper.	Per- ³ form.
Electrostatic discharge to case	IEC/EN 61000-4-2	2	contact discharge (R pin open)	4000 V _p	1/50 ns	330 Ω	10 positive and 10 negative discharges	yes	B
		3	air discharge (R pin open)	8000 V _p					
Electromagnetic field	IEC/EN 61000-4-3	3	antenna	10 V/m	AM 80% 1 kHz		26...1000 MHz	yes	A
	ENV 50204				PM, 50% duty cycle, 200 Hz resp. frequ.		900 MHz		
Electrical fast transient/burst	IEC/EN 61000-4-4	4	direct +i/-i	4000 V _p	bursts of 5/50 ns 5 kHz rep. rate transients with 15 ms burst duration and a 300 ms period	50 Ω	1 min positive 1 min negative transients per coupling mode	yes	B
Surge	IEC/EN 61000-4-5 ⁵	3	+i/-i	2000 V _p	1.2/50 μ s	2 Ω	5 pos. and 5 neg. impulses per coupling mode	yes	B
Conducted disturbances	IEC/EN 61000-4-6	3	+i/-i	10 V _{rms} (140 dB μ V)	AM modulated 80%, 1 kHz	50 Ω	0.15...80 MHz 150 Ω	yes	A
Transient	ETR 283 (19 Pfl 1) ⁴		+i/-i	150 V _p	0.1/0.3 ms	limited to <100 A	3 positive	yes	B

¹ Related and previous standards are referenced in: *Technical Information: Standards*.

² i = input, o = output.

³ A = normal operation, no deviation from specification, B = temporary deviation from specs. possible.

⁴ For 40 IMX 15 types (additional external components required). Not applicable for 20 IMX 15 types.

⁵ External components required.

Electromagnetic Emission

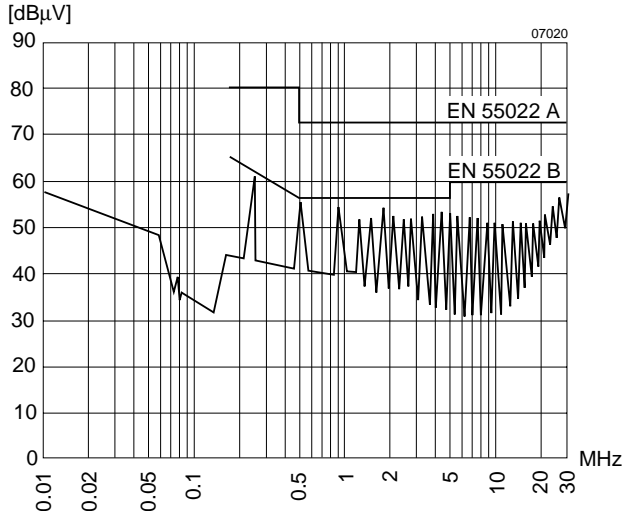

Fig. 21
Typical disturbance voltage (quasi-peak) at the input according to CISPR 11/EN 55011 and CISPR 22/EN 55022, measured at $U_{i\text{ nom}}$ and $I_{o\text{ nom}}$. Output leads 0.1 m, twisted. (40 IMX 15-05-7R)

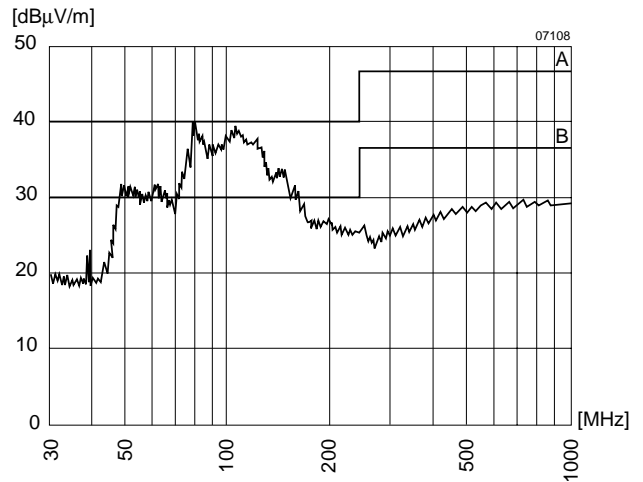

Fig. 22
Typical radio frequency-interference voltage at $U_{i\text{ nom}}$, $I_{o\text{ nom}}$, measured with an antenna (distance 10 m). Output leads 1 m, twisted.

CISPR 22/EN 55022, Level B Radiated

Electromagnetic emission requirements according to EN 55022, class B (radiated emission) can be achieved by adding an external common mode choke and (for 20 IMX 15 types) an additional capacitor, see: *Input Data*. The filter components should be placed as close as possible to the input of the converter.

Table 11: Input filter components for EN 55022, level B, radiated.

Type	Current compensated choke
20 IMX 15	1 mH, 2A
40 IMX 15	e.g. Tokin, type SC-02-10GS
110 IMY 15	

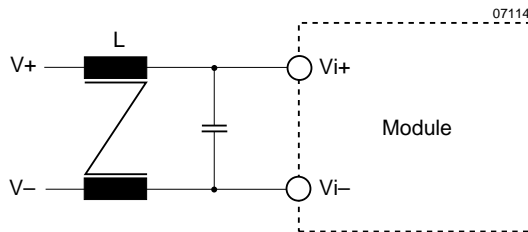

Fig. 25
Example for external circuitry to comply with CISPR22/EN 55022, level B, radiated

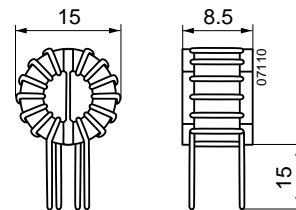

Fig. 23
Choke dimensions (Tokin SC-02-10GS)

Immunity to Environmental Conditions

Table 12: Temperature specifications, valid for air pressure of 800...1200 hPa (800...1200 mbar)

Temperature			-9		Option -8 ³		Unit
Characteristics	Conditions		min	max	min	max	
T_A	Ambient temperature ¹	Operational ²	-40	71	-40	85	°C
T_C	Case temperature		-40	95	-40	105	
T_S	Storage temperature ¹	Non operational	-55	100	-55	105	

¹ MIL-STD-810D section 501.2 and 502.2

² See: *Thermal Considerations*

³ Start up at -55°C

Table 13: MTBF and device hours

MTBF	Ground Benign	Ground Fixed		Ground Mobile
MTBF acc. to MIL-HDBK-217F	$T_C = 40^\circ\text{C}$	$T_C = 40^\circ\text{C}$	$T_C = 70^\circ\text{C}$	$T_C = 50^\circ\text{C}$
110 IMY 15-05-9R	485'000 h	255'000 h	167'000 h	223'000 h

Table 14: Mechanical stress

Test Method		Standard	Test Conditions		Status
Ca	Damp heat steady state	IEC/DIN IEC 60068-2-3 MIL-STD-810D section 507.2	Temperature: Relative humidity: Duration:	$40 \pm 2^\circ\text{C}$ 93 ^{+2/-3} % 56 days	Unit not operating
Ea	Shock (half-sinusoidal)	IEC/EN/DIN EN 60068-2-27 MIL-STD-810D section 516.3	Acceleration amplitude: Bump duration: Number of bumps:	$100 g_n = 981 \text{ m/s}^2$ 6 ms 18 (3 each direction)	Unit operating
Eb	Bump (half-sinusoidal)	IEC/EN/DIN EN 60068-2-29 MIL-STD-810D section 516.3	Acceleration amplitude: Bump duration: Number of bumps:	$40 g_n = 392 \text{ m/s}^2$ 6 ms 6000 (1000 each direction)	Unit operating
Fc	Vibration (sinusoidal)	IEC/EN/DIN EN 60068-2-6 MIL-STD-810D section 514.3	Acceleration amplitude: Frequency (1 Oct/min): Test duration:	0.35 mm (10...60 Hz) $5 g_n = 49 \text{ m/s}^2$ (60...2000 Hz) 10...2000 Hz 7.5 h (2.5 h each axis)	Unit operating
Fda	Random vibration wide band reproducibility high	IEC 60068-2-35	Acceleration spectral density: Frequency band: Acceleration magnitude: Test duration:	$0.05 g_n^2/\text{Hz}$ 20...500 Hz $4.9 g_{n \text{ rms}}$ 3 h (1 h each axis)	Unit operating
Kb	Salt mist, cyclic (sodium chloride NaCl solution)	IEC/EN/DIN IEC 60068-2-52	Concentration: Duration: Storage: Storage duration: Number of cycles:	5% (30°C) 2 h per cycle 40°C, 93% rel. humidity 22 h per cycle 3	Unit not operating

Mechanical Data

Dimensions in mm. Tolerances ± 0.3 mm unless otherwise indicated.

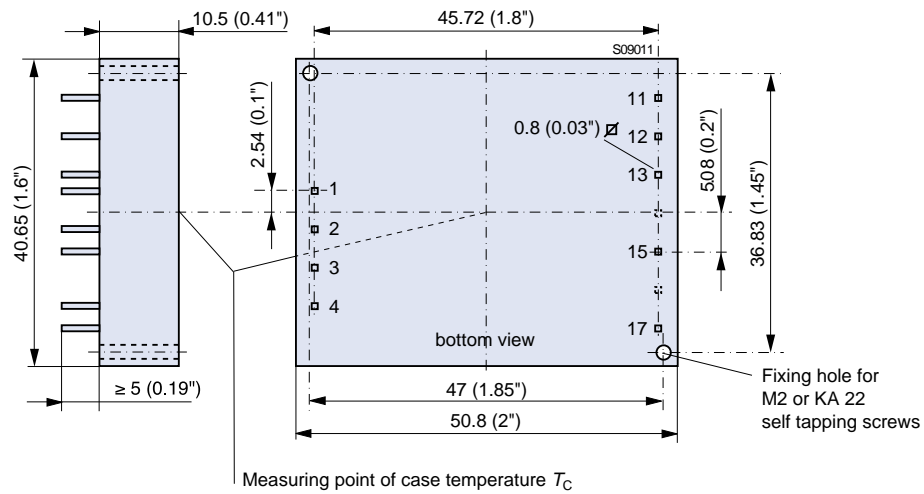

Fig. 24
Case IMX 15, IMY 15
Weight: <35 g

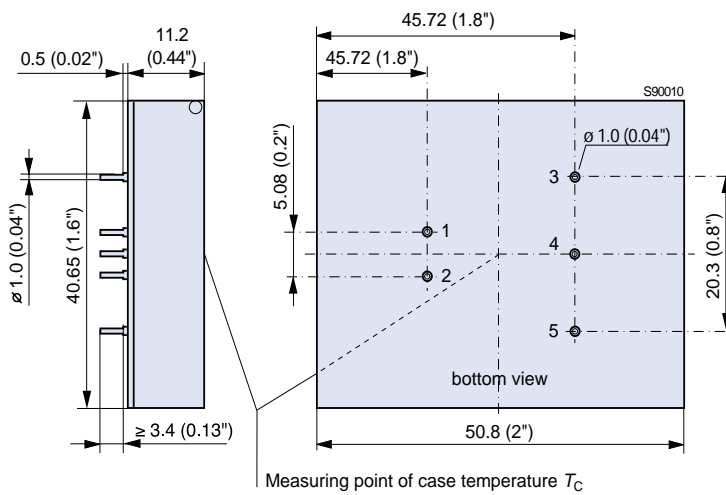

Fig. 25
C pinout (option C)

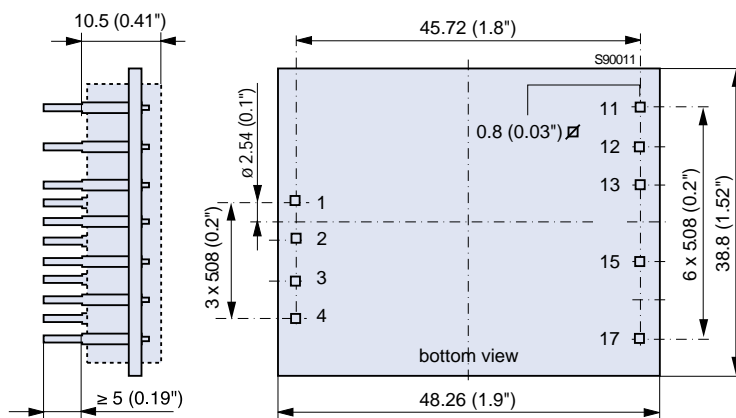

Fig. 26
Open frame (option Z)

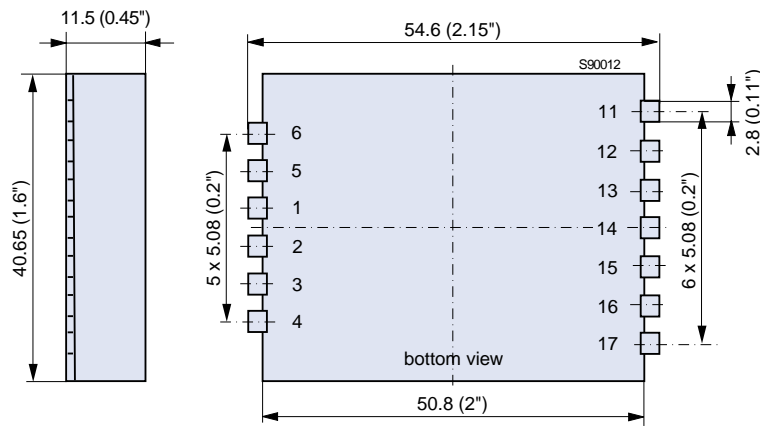

Fig. 27
Surface mount version with PCB lid (option L)

Safety and Installation Instructions

Installation Instructions

Installation of the DC-DC converters must strictly follow the national safety regulations in compliance with the enclosure, mounting, creepage, clearance, casualty, markings and segregation requirements of the end-use application.

Connection to the system shall be made via a printed circuit board with hole diameters of $1.4 \text{ mm} \pm 0.1 \text{ mm}$ for the pins.

The units should be connected to a secondary circuit.

Check for hazardous voltages before altering any connections.

Do not open the module.

Ensure that a unit failure (e.g. by an internal short-circuit) does not result in a hazardous condition. See also: *Safety of operator accessible output circuit*.

Input Fuse

To prevent excessive current flowing through the input supply line in case of a short-circuit across the converter input an external fuse should be installed in a non earthed input supply line. We recommend a fast acting fuse F4.0A for 20 IMX 15 types, F2.0 A for 40 IMX 15 types and a fuse F1.0A for 110 IMY 15 types.

Standards and approvals

All DC-DC converters are pending to be UL recognized according to UL 1950, UL recognized for Canada to CAN/CSA C22.2 No. 950-95 and LGA approved to IEC/EN 60950 standards.

The units have been evaluated for:

- Building in
- Supplementary insulation input to output, based on their maximum input voltage (IMX 15 types)
- Reinforced insulation input to output, based on their maximum input voltage (IMY 15 types)
- The use in a pollution degree 2 environment
- Connecting the input to a secondary circuit which is subject to a maximum transient rating of 1500 V (IMX 15 types)
- Connecting the input to a primary circuit which is subject to a maximum transient rating of 2500 V (IMY 15 types)

After approvals the DC-DC converters are subject to manufacturing surveillance in accordance with the above mentioned UL, CSA, EN and with ISO 9001 standards.

Table 15: Pin allocation

Pin	Standard and Option Z			Option K	Option C		Option L	
	single	double	-0503-	dual	single	dual	single	double
1	Vi+	Vi+	Vi+	Vi+	Vi+	Vi+	Vi+	Vi+
2	Vi-	Vi-	Vi-	Vi-	Vi-	Vi-	Vi-	Vi-
3	-	Trim	n.c.	-	Vo+	Vo+	n.c.	Trim
4	\overline{SD}	\overline{SD}	\overline{SD}	\overline{SD}	-	Go	\overline{SD}	\overline{SD}
5	-	-	-	-	Vo-	Vo-	n.c.	n.c.
6	-	-	-	-	-	-	n.c.	n.c.
11	-	Vo1+	Vo2+	Vo+	-	-	n.c.	Vo1-
12	-	Vo1-	Go	-	-	-	n.c.	Vo2-
13	Vo+	Vo2+	Vo1+	Go	-	-	Vo+	Vo1+
15	Vo-	Vo2-	Go	Vo-	-	-	Vo-	Vo2-
17	R	n.c.	R	n.c.	-	-	R	n.c.

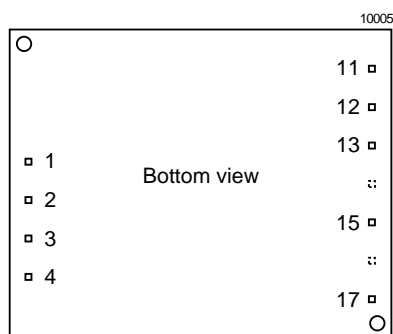

Fig. 28
Pin allocation

Protection Degree

The protection degree of the DC-DC converters is IP 40.

Cleaning Agents

In order to avoid possible damage, any penetration of cleaning fluids should be prevented, since the power supplies are not hermetically sealed.

Isolation

The electric strength test is performed as factory test in accordance with IEC/EN 60950 and UL 1950 and should not be repeated in the field. Power-One will not honour any guarantee claims resulting from electric strength field tests.

Table 16: Electric strength test voltages

Characteristic	Input to output		Output to output	Unit
	IMX 15	IMY 15		
Electric strength test voltage 1 s	1.2	3.0	0.1	kV _{rms}
	1.5	4.0	0.15	kV DC
Insulation resistance at 500 V DC	>100	>100	-	MΩ
Partial discharge extinction voltage	Consult factory		-	kV

Safety of operator accessible output circuit

If the output circuit of a DC-DC converter is operator accessible, it shall be an SELV circuit according to the IEC/EN 60950 related safety standards

The following table shows some possible installation configurations, compliance with which causes the output circuit of the DC-DC converter to be an SELV circuit according to

IEC/EN 60950 up to a configured output voltage (sum of nominal voltages if in series or +/- configuration) of 42 V.

However, it is the sole responsibility of the installer to ensure the compliance with the relevant and applicable safety regulations. More information is given in: *Technical Information: Safety*.

Table 17: Insulation concept leading to an SELV output circuit

Conditions	Front end			DC-DC converter		Result
	Minimum required grade of isolation, to be provided by the AC-DC front end, including mains supplied battery charger	Maximum DC output voltage from the front end ¹	Minimum required safety status of the front end output circuit	Type	Measures to achieve the specified safety status of the output circuit	
Mains ≤150 V AC	Operational (i.e. there is no need for electrical isolation between the mains supply voltage and the DC-DC converter input voltage)	≤150 V	Primary	IMY 15	Double or reinforced insulation, based on 150 V AC and DC (provided by the DC-DC converter)	SELV circuit
Mains ≤250 V AC	Basic	≤60 V	Earthed SELV circuit ²	IMX 15 IMY 15	Operational insulation (provided by the DC-DC converter)	SELV circuit
		≤75 V	Hazardous voltage secondary circuit	IMX 15	Input fuse ³ output suppressor diodes ⁴ , and earthed output circuit ²	
		≤150 V		IMY 15	Supplementary insulation based on 250 V AC and double or reinforced insulation, based on the maximum rated output voltage from the front end (provided by the DC-DC converter)	SELV circuit
	Double or reinforced	≤60 V	SELV circuit	IMX 15 IMY 15	Operational insulation (provided by the DC-DC converter)	SELV circuit
		≤75 V	Double or reinforced insulated unearthed hazardous voltage secondary circuit ⁵	IMX 15	Supplementary insulation based on the maximum rated output voltage from the front end (provided by the DC-DC converter)	
		≤120 V	TNV-2 circuit	IMY 15	Double or reinforced insulation, based on the maximum rated output voltage from the front end (provided by the DC-DC converter)	
		≤150 V	Double or reinforced insulated earthed or unearthed hazardous voltage secondary circuit			

¹ The front end output voltage should match the specified input voltage range of the DC-DC converter.

² The earth connection has to be provided by the installer according to the relevant safety standard, e.g. IEC/EN 60950.

³ The installer shall provide an approved fuse (type with the lowest rating suitable for the application) in a non-earthed input conductor directly at the input of the DC-DC converter (see fig.: *Schematic safety concept*). For UL's purpose, the fuse needs to be UL-listed. See also: *Input Fuse*.

⁴ Each suppressor diode should be dimensioned in such a way, that in the case of an insulation fault the diode is able to limit the output voltage to SELV (<60 V) until the input fuse blows (see fig.: *Schematic safety concept*).

⁵ Has to be insulated from earth by at least basic insulation according to the relevant safety standard, based on the maximum output voltage from the front end.

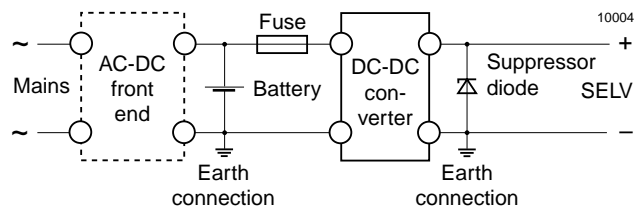

Fig. 29 Schematic safety concept. Use fuse, suppressor diode and earth connection as per table Safety concept leading to an SELV output circuit.

Description of Options

Table 18: Survey of options

Option	Function of option	Characteristic
-8	Extended operational ambient temperature range	$T_A = -40...85^\circ\text{C}$
K	Alternativ pinout	See mechanical data
i	Inhibit	
C	C-pinout	See mechanical data
L	Surface mount version with PCB lid	See mechanical data
Z	Open frame	See mechanical data

Option -8 Extended Temperature Range

Extension of the temperature range from standard $-40...85^\circ\text{C}$. In the upper temperature range the output power derating below should be observed. The modules will provide the specified output power with free air convection cooling.

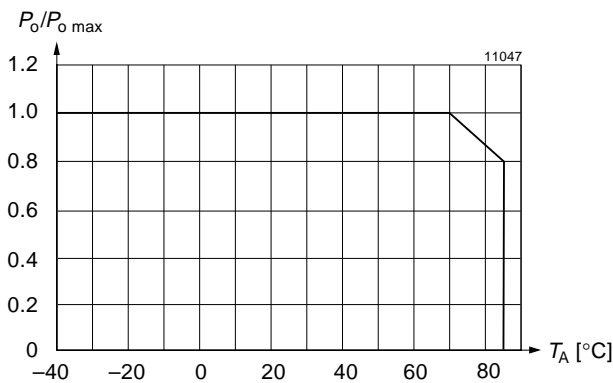

Fig. 30
Maximum allowed output power versus ambient temperature.

Option K Alternative Pinout

Option K configures the electrically isolated double outputs to the alternative pinout with outputs connected in series ($V_{o+}/G_o/V_{o-}$) and common ground.

However instead of using units with option K, it is recommended to use the standard double output units by providing the printed circuit board with an additional pin hole (for pin 12 of double output units) connected to pin hole 13. This will provide more design-in flexibility since by that both pinouts may be used on the same PCB.

Option i Inhibit

Excludes shut down and option K.

The output(s) of the converter may be enabled or disabled by means of a logic signal (TTL, CMOS, etc.) applied to the inhibit pin. No output voltage overshoot will occur when the unit is turned on. If the inhibit function is not required the inhibit pin should be connected to V_{i-} to enable the output (active low logic, fail safe).

Converter operating: $-10\text{ V}...0.8\text{ V}$

Converter inhibited
or inhibit left open circuit: $2.4\text{ V}...U_{i\text{ max}} (<75\text{ V})$

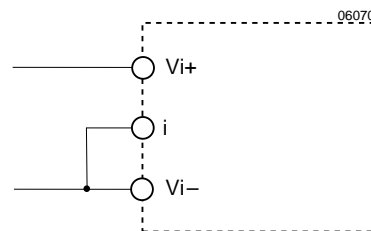

Fig. 31
If the inhibit is not used the inhibit pin should be connected to V_{i-}