

## Input Rectifier Diode TO-220 FULL-PAK, 10 A

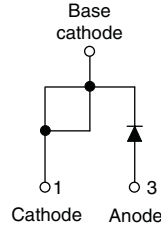

TO-220AC FULL-PAK



### DESCRIPTION

The 10ETS12FPPbF rectifier series has been optimized for very low forward voltage drop, with moderate leakage. The glass passivation technology used has reliable operation up to 150 °C junction temperature.



RoHS\*  
COMPLIANT

Typical applications are in input rectification and these products are designed to be used with Vishay HPP switches and output rectifiers which are available in identical package outlines.

Fully isolated package ( $V_{INS} = 2500 V_{RMS}$ ) is UL E78996 approved

This product has been designed and qualified for industrial level and lead (Pb)-free ("PbF" suffix).

### PRODUCT SUMMARY

$V_F$ at 10 A	< 1.1 V
$I_{FSM}$	200 A
$V_{RRM}$	800/1200 V

### OUTPUT CURRENT IN TYPICAL APPLICATIONS

APPLICATIONS	SINGLE-PHASE BRIDGE	THREE-PHASE BRIDGE	UNITS
Capacitive input filter $T_A = 55\text{ °C}$ , $T_J = 125\text{ °C}$ common heatsink of 1 °C/W	12.0	16.0	A

### MAJOR RATINGS AND CHARACTERISTICS

SYMBOL	CHARACTERISTICS	VALUES	UNITS
$I_{F(AV)}$	Sinusoidal waveform	10	A
$V_{RRM}$	Range	800/1200	V
$I_{FSM}$		200	A
$V_F$	10 A, $T_J = 25\text{ °C}$	1.1	V
$T_J$		- 40 to 150	°C

### VOLTAGE RATINGS

PART NUMBER	$V_{RRM}$ , MAXIMUM PEAK REVERSE VOLTAGE V	$V_{RSM}$ , MAXIMUM NON-REPETITIVE PEAK REVERSE VOLTAGE V	$I_{RRM}$ AT 150 °C mA
10ETS08FPPbF	800	900	0.5
10ETS12FPPbF	1200	1300	

### ABSOLUTE MAXIMUM RATINGS

PARAMETER	SYMBOL	TEST CONDITIONS	VALUES	UNITS
Maximum average forward current	$I_{F(AV)}$	$T_C = 105\text{ °C}$ , 180° conduction half sine wave	10	A
Maximum peak one cycle non-repetitive surge current	$I_{FSM}$	10 ms sine pulse, rated $V_{RRM}$ applied	170	
		10 ms sine pulse, no voltage reapplied	200	
Maximum $I^2t$ for fusing	$I^2t$	10 ms sine pulse, rated $V_{RRM}$ applied	130	A <sup>2</sup> s
		10 ms sine pulse, no voltage reapplied	145	
Maximum $I^2\sqrt{t}$ for fusing	$I^2\sqrt{t}$	$t = 0.1$ to 10 ms, no voltage reapplied	1450	A <sup>2</sup> √s

\* Pb containing terminations are not RoHS compliant, exemptions may apply

# 10ETS..FPPbF High Voltage Series



Vishay High Power Products Input Rectifier Diode  
TO-220 FULL-PAK, 10 A

ELECTRICAL SPECIFICATIONS					
PARAMETER	SYMBOL	TEST CONDITIONS		VALUES	UNITS
Maximum forward voltage drop	$V_{FM}$	10 A, $T_J = 25\text{ }^\circ\text{C}$		1.1	V
Forward slope resistance	$r_t$	$T_J = 150\text{ }^\circ\text{C}$		20	$m\Omega$
Threshold voltage	$V_{F(TO)}$			0.82	V
Maximum reverse leakage current	$I_{RM}$	$T_J = 25\text{ }^\circ\text{C}$	$V_R = \text{Rated } V_{RRM}$	0.05	mA
		$T_J = 150\text{ }^\circ\text{C}$		0.50	

THERMAL - MECHANICAL SPECIFICATIONS					
PARAMETER	SYMBOL	TEST CONDITIONS		VALUES	UNITS
Maximum junction and storage temperature range	$T_J, T_{Stg}$			- 40 to 150	$^\circ\text{C}$
Maximum thermal resistance, junction to case	$R_{thJC}$	DC operation		2.5	$^\circ\text{C/W}$
Maximum thermal resistance, junction to ambient	$R_{thJA}$			62	
Typical thermal resistance, case to heatsink	$R_{thCS}$	Mounting surface, smooth and greased		0.5	
Approximate weight				2	g
				0.07	oz.
Mounting torque	minimum			6 (5)	kgf · cm (lbf · in)
	maximum			12 (10)	
Marking device		Case style TO-220 FULL-PAK (94/V0)		10ETS12FP	



# 10ETS..FPPbF High Voltage Series

Input Rectifier Diode  
TO-220 FULL-PAK, 10 A

Vishay High Power Products

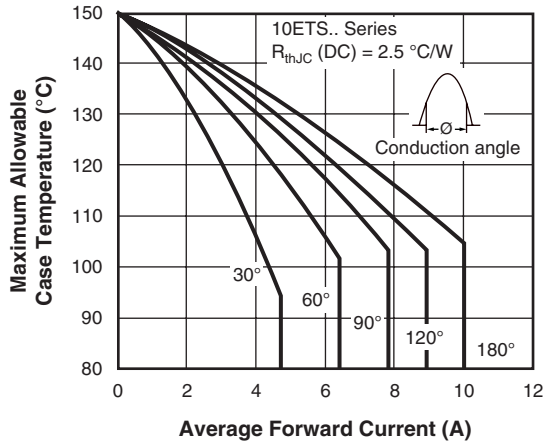

Fig. 1 - Current Rating Characteristics

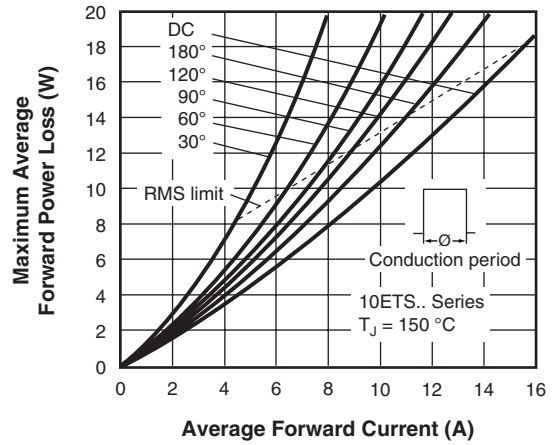

Fig. 4 - Forward Power Loss Characteristics

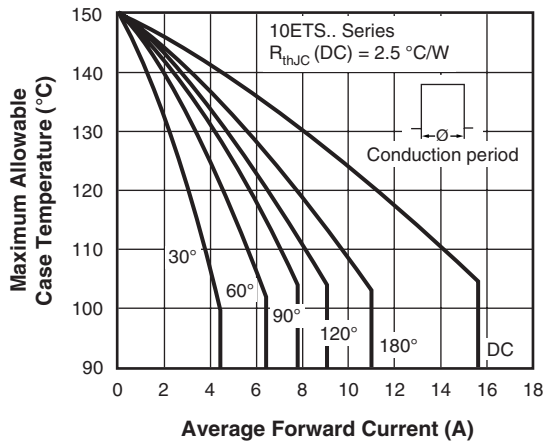

Fig. 2 - Current Rating Characteristics

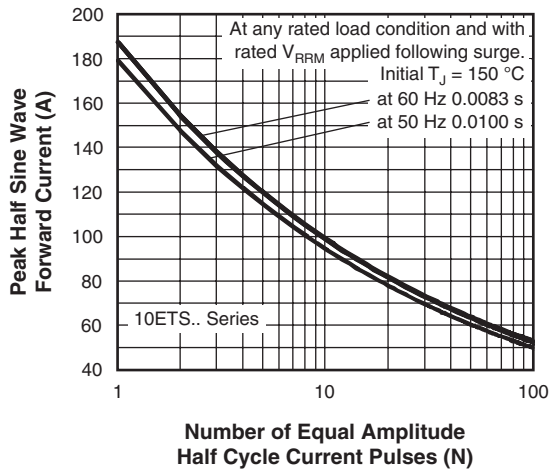

Fig. 5 - Maximum Non-Repetitive Surge Current

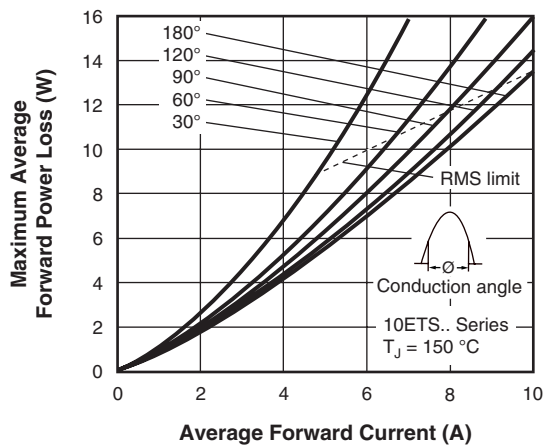

Fig. 3 - Forward Power Loss Characteristics

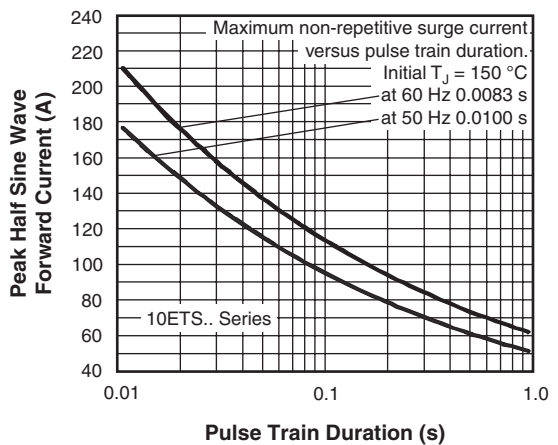

Fig. 6 - Maximum Non-Repetitive Surge Current

# 10ETS..FPPbF High Voltage Series



Vishay High Power Products

Input Rectifier Diode  
TO-220 FULL-PAK, 10 A

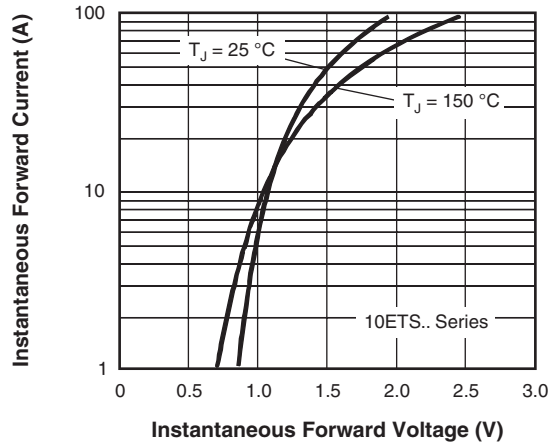

Fig. 7 - Forward Voltage Drop Characteristics

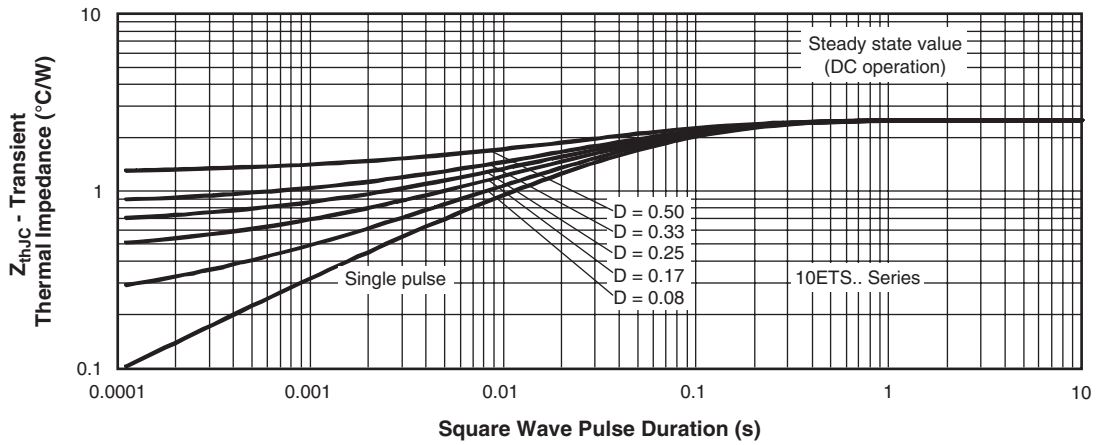

Fig. 8 - Thermal Impedance  $Z_{thJC}$  Characteristics



# 10ETS..FPPbF High Voltage Series

Input Rectifier Diode  
TO-220 FULL-PAK, 10 A

Vishay High Power Products

## ORDERING INFORMATION TABLE

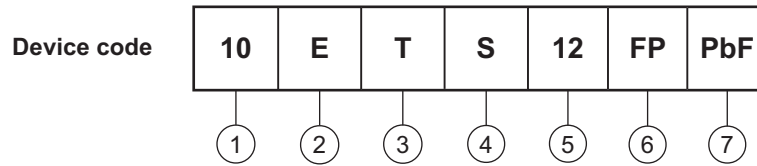

- 1** - Current rating (10 = 10 A)
- 2** - Circuit configuration:  
E = Single diode
- 3** - Package:  
T = TO-220AC
- 4** - Type of silicon:  
S = Standard recovery rectifier
- 5** - Voltage rating ————— 

08 = 800 V
12 = 1200 V
- 6** - FULL-PAK
- 7** -
  - None = Standard production
  - PbF = Lead (Pb)-free

LINKS TO RELATED DOCUMENTS	
Dimensions	<a href="http://www.vishay.com/doc?95005">http://www.vishay.com/doc?95005</a>
Part marking information	<a href="http://www.vishay.com/doc?95009">http://www.vishay.com/doc?95009</a>



**DIMENSIONS** in millimeters

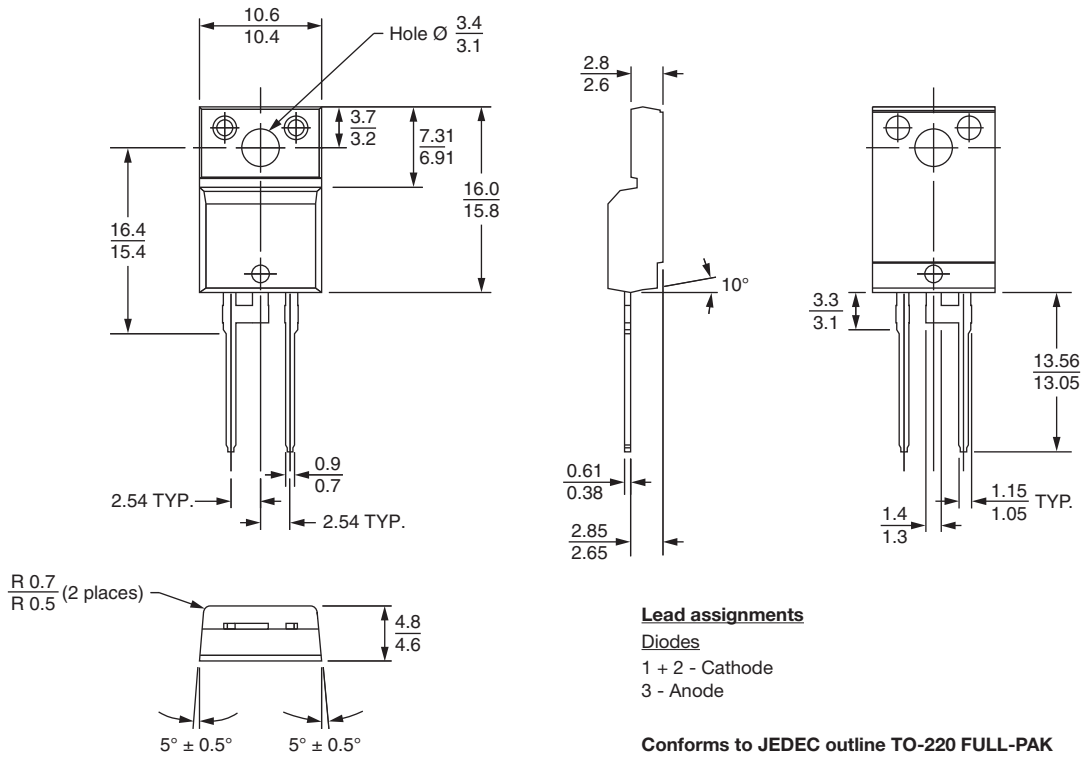

### Lead assignments

- Diodes**  
1 + 2 - Cathode  
3 - Anode

Conforms to JEDEC outline TO-220 FULL-PAK



## Disclaimer

ALL PRODUCT, PRODUCT SPECIFICATIONS AND DATA ARE SUBJECT TO CHANGE WITHOUT NOTICE TO IMPROVE RELIABILITY, FUNCTION OR DESIGN OR OTHERWISE.

Vishay Intertechnology, Inc., its affiliates, agents, and employees, and all persons acting on its or their behalf (collectively, "Vishay"), disclaim any and all liability for any errors, inaccuracies or incompleteness contained in any datasheet or in any other disclosure relating to any product.

Vishay makes no warranty, representation or guarantee regarding the suitability of the products for any particular purpose or the continuing production of any product. To the maximum extent permitted by applicable law, Vishay disclaims (i) any and all liability arising out of the application or use of any product, (ii) any and all liability, including without limitation special, consequential or incidental damages, and (iii) any and all implied warranties, including warranties of fitness for particular purpose, non-infringement and merchantability.

Statements regarding the suitability of products for certain types of applications are based on Vishay's knowledge of typical requirements that are often placed on Vishay products in generic applications. Such statements are not binding statements about the suitability of products for a particular application. It is the customer's responsibility to validate that a particular product with the properties described in the product specification is suitable for use in a particular application. Parameters provided in datasheets and/or specifications may vary in different applications and performance may vary over time. All operating parameters, including typical parameters, must be validated for each customer application by the customer's technical experts. Product specifications do not expand or otherwise modify Vishay's terms and conditions of purchase, including but not limited to the warranty expressed therein.

Except as expressly indicated in writing, Vishay products are not designed for use in medical, life-saving, or life-sustaining applications or for any other application in which the failure of the Vishay product could result in personal injury or death. Customers using or selling Vishay products not expressly indicated for use in such applications do so at their own risk and agree to fully indemnify and hold Vishay and its distributors harmless from and against any and all claims, liabilities, expenses and damages arising or resulting in connection with such use or sale, including attorneys fees, even if such claim alleges that Vishay or its distributor was negligent regarding the design or manufacture of the part. Please contact authorized Vishay personnel to obtain written terms and conditions regarding products designed for such applications.

No license, express or implied, by estoppel or otherwise, to any intellectual property rights is granted by this document or by any conduct of Vishay. Product names and markings noted herein may be trademarks of their respective owners.