

SPECIFICATION FOR LCD MODULE

Model No. TM10064ACIWG-1

Prepared by:	Date:
Checked by :	Date:
Verified by :	Date:
Approved by:	Date:

TIANMA MICROELECTRONICS CO., LTD

REVISION RECORD

Date	Ref. Page	Revision No.	Revision Items	Check & Approval

1 General Specifications:

1.1 Display type: **STN**

1.2 Display color*:

Display color: **Blue-Black**

Background: **White**

1.3 Polarizer mode: **Transflective/Positive**

1.4 Viewing Angle: **6:00**

1.5 Driving Method: **1/65 Duty 1/9 Bias**

1.6 Without Backlight

* Color tone is slightly changed by temperature and driving voltage.

1.7 Data Transfer: **8 Bit Parallel**

1.8 Operating Temperature: **-10----+50°C**

Storage Temperature: **-15----+60°C**

1.9 Outline Dimensions: **Refer to outline drawing on next page**

1.10 Dot Matrix: **100X 64 DOTS**

1.10 Dot Size: **0.33X0.33(mm)**

1.11 Dot Pitch: **0.36X0.36 (mm)**

1.12 Weight: **15g**

1	/CS1
2	/RES
3	RS
4	/WR
5	/RD
6	D0
7	D1
8	D2
9	D3
10	D4
11	D5
12	D6
13	D7
14	VDD
15	VSS
16	VOUT
17	C3+
18	C1-
19	C1+
20	C2+
21	C2-
22	REF
23	V1
24	V2
25	V3
26	V4
27	V0
28	C68
29	P/S
30	/HPM

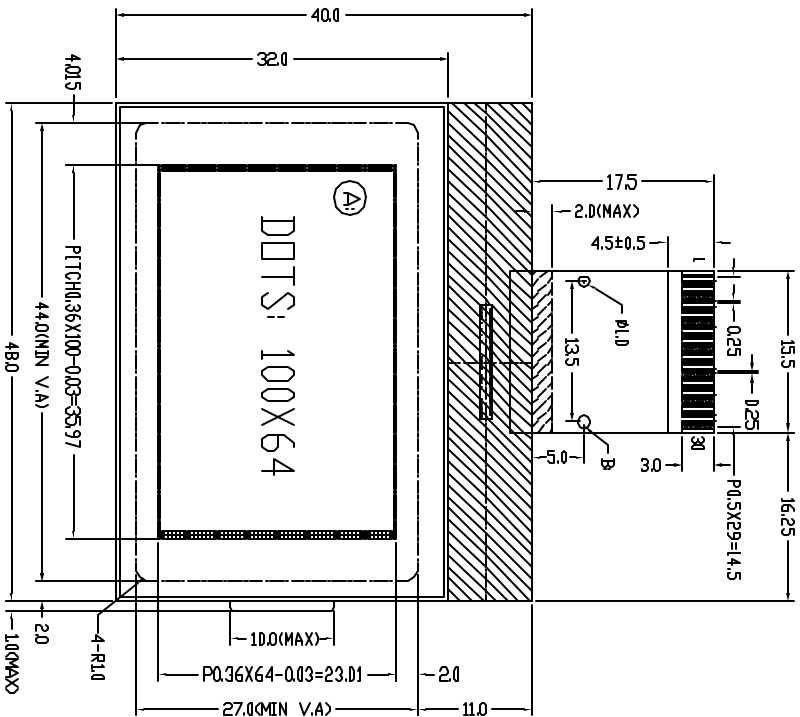

- NOTES:
1. DISPLAY TYPE: FSTN
 2. VIEWING DIRECTION: 6:00
 3. POLARIZER MODE: TRANSPARENT/POSITIVE
 4. LOGIC VOLTAGE: 3.0V
 5. LCD OPERATING VOLTAGE: 9.0V
 6. DRIVE METHOD: 1/65 DUTY 1/9 BIAS
 7. OPERATING TEMP: -10°C~+50°C
 8. STORAGE TEMP: -15°C~+60°C
 9. CONTROLLER: S6B0724A01-B0CY
 10. WITHOUT BACKLIGHT
 11. UNMARKED TOLERANCES: ±0.3

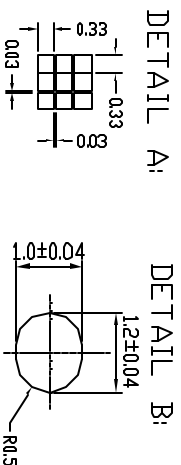
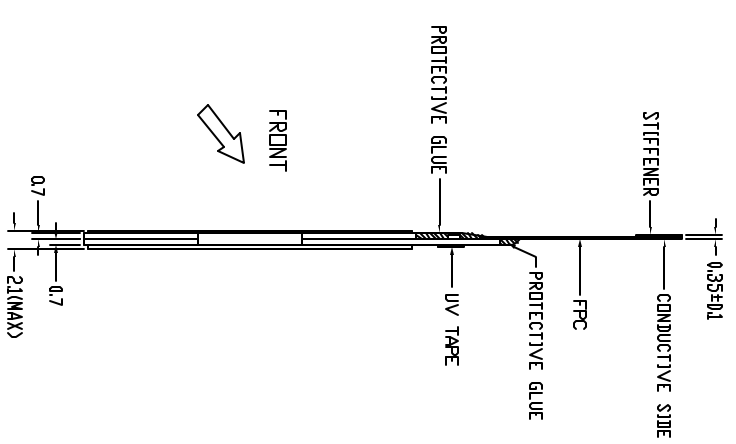

TIAN-VA MICROELECTRONICS CO.
 6/F., CASTLE Building, Shekou Road, Centre 1, Shenzhen, China

DRAWN BY:	CHKD BY:	TITLE: TM10064ACTW-G-1	SCALE:
CHECKED BY:	APPROVED BY:	DWG NO: G-1	DATE: 2008
CONTINUED BY:		DWG NAME: TM10064ACTW-G-1	SHEET NO: 1 OF 1

3 LCD Module Part Numbering System

T M 10064 A C I W G-1

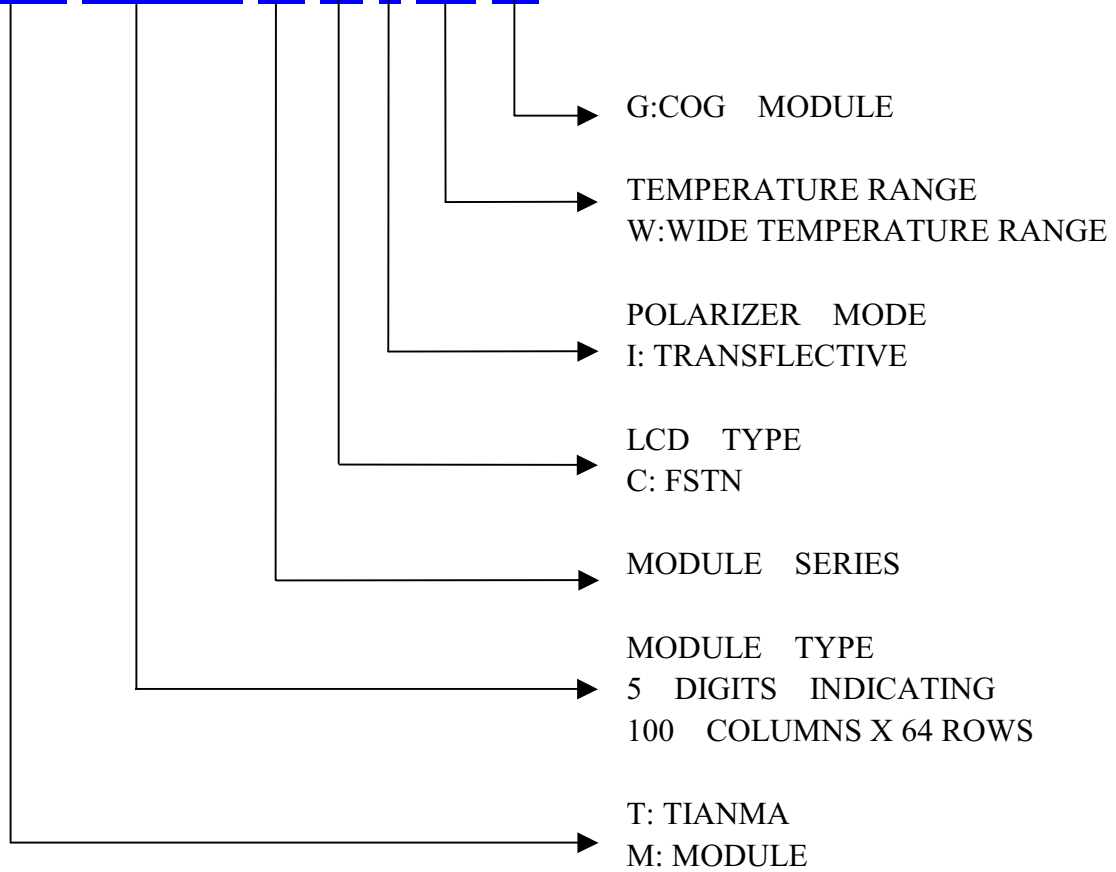

5 Absolute Maximum Ratings

Item	Symbol	Min.	Max.	Unit	Remark
Power Supply Voltage	$V_{DD}-V_{SS}$	-0.3	6.0	V	
LCD Driving Voltage	V_{LCD}	-0.3	12.0		
Operating Temperature Range	T_{OP}	-10	+50	°C	No Condensation
Storage Temperature Range	T_{ST}	-15	+60		

6 Electrical Specifications and Instruction Code

6.1 Electrical characteristics

Item	Symbol	Min.	Typ.	Max.	Unit	
Supply Voltage (Logic)	$V_{DD}-V_{SS}$	2.4	3.0	3.5	V	
Supply Voltage (LCD Drive)	V_{LCD}	7.5	9.0	10.5	V	
Input Signal Voltage	High	V_{IH} ($V_{DD}=3.0$)	$0.7V_{DD}$	-	$V_{DD}+0.3$	V
	Low	V_{IL} ($V_{DD}=3.0$)	-0.3	-	$0.2 V_{DD}$	V
Supply current (Logic)	I_{DD} ($V_{DD}-V_{SS}=3.0$)	-	50	100	uA	

6.2 Interface Signals

Pin No.	Symbol	Level	Description
1	CS	H/L	Chip select input
2	RESB	H/L	Reset signal input
3	A0	H/L	Selects registers input
4	/WR	H/L	Write data enable
5	/RD	H/L	Read data enable
6	D0	H/L	Data bit 0
7	D1	H/L	Data bit 1
8	D2	H/L	Data bit 2
9	D3	H/L	Data bit 3
10	D4	H/L	Data bit 4
11	D5	H/L	Data bit 5
12	D6	H/L	Data bit 6
13	D7	H/L	Data bit 7
14	VDD	3.0V	Power supply voltage for logic
15	VSS	0V	Ground
16	VOOUT	-	Voltage convert I/O port
17	C3+	-	Capacitor pin for voltage converter
18	C1-	-	Capacitor pin for voltage converter
19	C1+	-	Capacitor pin for voltage converter
20	C2+	-	Capacitor pin for voltage converter
21	C2-	-	Capacitor pin for voltage converter
22	VRS	H/L	Voltage regulator selection
23	V1	8.4v	Power supply voltage for LCD
24	V2	7.4v	Power supply voltage for LCD
25	V3	2.1v	Power supply voltage for LCD
26	V4	1.1v	Power supply voltage for LCD
27	V0	9.5v	Power supply voltage for LCD

Interface Signals (continued)

Pin No.	Symbol	Level	Description
28	C86	H/L	MPU interface switch terminal
29	P/S	H/L	Parallel/serial data input switch terminal
30	/HPM	H/L	Power control terminal

6.3 Interface Timing Chart

AC Characteristics

(1) System buses Read/Write characteristics 1 (For the 8080 Series MPU)

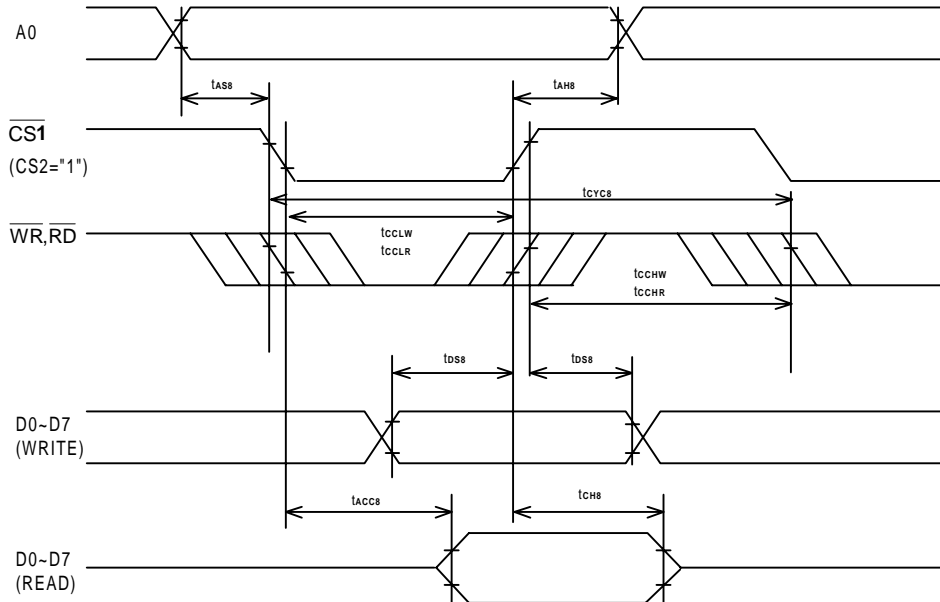

(VDD=2.7 – 3.3V, TA = -40 - 85°C)

Symbol	Parameter	Min.	Typ.	Max.	Unit	Condition
TAH8	Address hold time	0			ns	
TAS8	Address setup time	0			ns	
TCYC8	System cycle time	300			ns	
TCCLW	Control L pulse width (WR)	60			ns	
TCCLR	Control L pulse width (RD)	120			ns	
TCCHW	Control H pulse width (WR)	60			ns	
TCCHR	Control H pulse width (RD)	60			ns	
TDS8	Data setup time	40			ns	
7TDH8	Data hold time	15			ns	
TACC8	\overline{RD} access time			140	ns	CL=100pF
TCH8	Output disable time	10		100	ns	CL=100pF

(2) System buses Read/Write Characteristics 2 (6800 Series MPU)

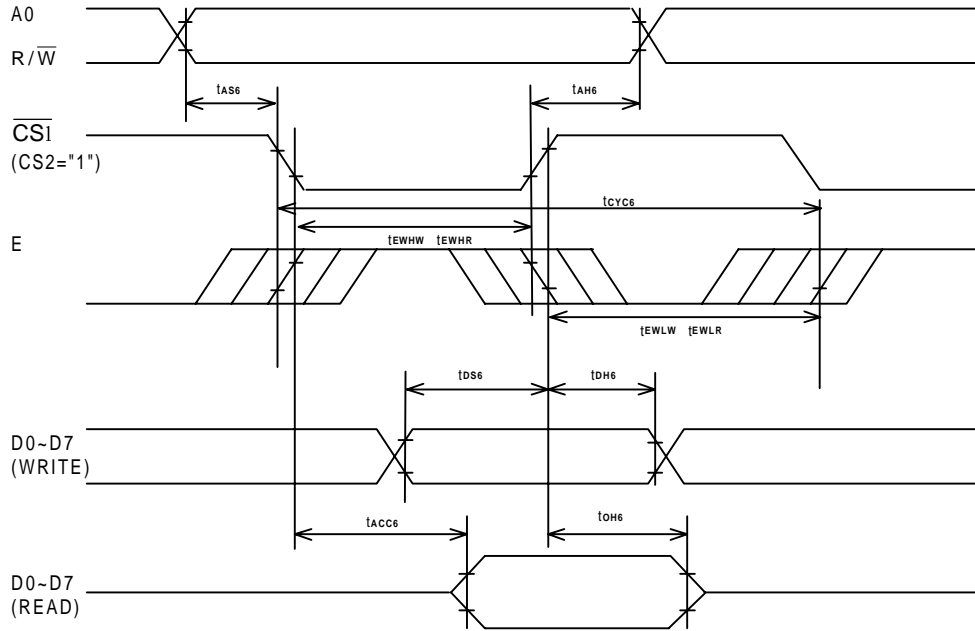

($V_{DD}=2.7 - 3.3V$, $T_A = -40 - 85^{\circ}C$)

Symbol	Parameter	Min.	Typ.	Max.	Unit	Condition
T_{CYC6}	System cycle time	300			nS	
T_{AS6}	Address setup time	0			nS	
T_{AH6}	Address hold time	0			nS	
T_{DS6}	Data setup time	40			nS	
T_{DH6}	Data hold time	15			nS	
T_{OH6}	Output disable time	10		100	nS	$C_L=100pF$
T_{ACC6}	Access time			140	nS	$C_L=100pF$
T_{EWHR}	Enable H pulse width (Read)	120			nS	
T_{EWHW}	Enable H pulse width (Write)	60			nS	
T_{EWLR}	Enable L pulse width (Read)	60			nS	
T_{EWLW}	Enable L pulse width (Write)	60			nS	

6.4 Instruction Code

Command	Code											Function
	A0	\overline{RD}	\overline{WR}	D7	D6	D5	D4	D3	D2	D1	D0	
(1) Display ON/OFF	0	1	0	1	0	1	0	1	1	1	D	Turns on LCD panel when goes high, and turns off when goes low
(2) Set Display Start Line	0	1	0	0	1	Display start address					Specifies RAM display line for COM0	
(3) Set Page Address	0	1	0	1	0	1	1	Page address				Sets the display RAM page in Page Address register
(4) Set Column Address 4 higher bits	0	1	0	0	0	0	1	Higher column address				Sets 4 higher bits of column address of display RAM in register
(4) Set column Address 4 lower bits	0	1	0	0	0	0	0	Lower column address				Sets 4 lower bits of column address of display RAM in register
(5) Read Status	0	0	1	Status				0	0	0	0	Reads the status information
(6) Write Display Data	1	1	0	Write data								Writes data in display RAM
(7) Read Display Data	1	0	1	Read data								Reads data from display RAM
(8) ADC select	0	1	0	1	0	1	0	0	0	0	D	Sets the display RAM address SEG output correspondence
(9) Normal/Reverse Display	0	1	0	1	0	1	0	0	1	1	D	Normal indication when low, but full indication when high
(10) Entire Display ON/OFF	0	1	0	1	0	1	0	0	1	0	0 1	Selects normal display (0) or Entire Display ON (1)
(11) Set LCD Bias	0	1	0	1	0	1	0	0	0	1	D	Sets LCD drive voltage bias ratio
(12) Read-Modify-Write	0	1	0	1	1	1	0	0	0	0	0	Increments Column Address counter during each write
(13) End	0	1	0	1	1	1	0	1	1	1	0	Releases the Read-Modify-Write
(14) Reset	0	1	0	1	1	1	0	0	0	1	0	Resets internal functions
(15) Common output mode select	0	1	0	1	1	0	0	D	*	*	*	Selects COM output scan direction. * Invalid data
(16) Set Power Control	0	1	0	0	0	1	0	1	Operation status			Selects the power circuit operation mode
(17) V0 voltage regulator internal resistor ratio set	0	1	0	0	0	1	0	0	Resistor ratio			Select internal resistor ratio (Rb / Ra) mode
(18) Electronic volume mode set	0	1	0	1	0	0	0	0	0	0	1	Set the V0 output voltage electronic volume register
Electronic Volume Register set	0	1	0	*	*	Electronic control value						
(19) Set static indicator On/Off	0	1	0	1	0	1	0	1	1	0	D	Set static indicator On/Off 0: OFF 1: ON
Set Static indicator register	0	1	0	*	*	*	*	*	*	Mode		Set the flashing mode
(20) Power Save	-	-	-	-	-	-	-	-	-	-	-	Compound command of display OFF and entire display ON
(21) NOP	0	1	0	1	1	1	0	0	0	1	1	Command for non-operation
(22) Test Command	0	1	0	1	1	1	1	*	*	*	*	IC Test command. Do not use!
(23) Test Mode Reset	0	1	0	1	1	1	1	0	0	0	0	Command of test mode reset

Note: Do not use any other command, or the system malfunction may result.

7 Optical Characteristics

7.1 Optical Characteristics

Ta=25°C

Item	Symbol	Condition	Min.	Typ.	Max.	Unit
Viewing Angle	θ_x	$C_r \geq 2$				Deg
	θ_y					
		$\theta_y = 0^\circ$		-30	--	20
		$\theta_x = 0^\circ$		-30	--	30
Contrast Ratio	C_r	$\theta_x = 0^\circ$ $\theta_y = 0^\circ$	3	-	-	
Response Time	Turn on	T_{on}				ms
	Turn off	T_{off}				
		$\theta_x = 0^\circ$ $\theta_y = 0^\circ$		-	-	300
				-	-	300

7.2 Definition of Optical Characteristics

7.2.1 Definition of Viewing Angle

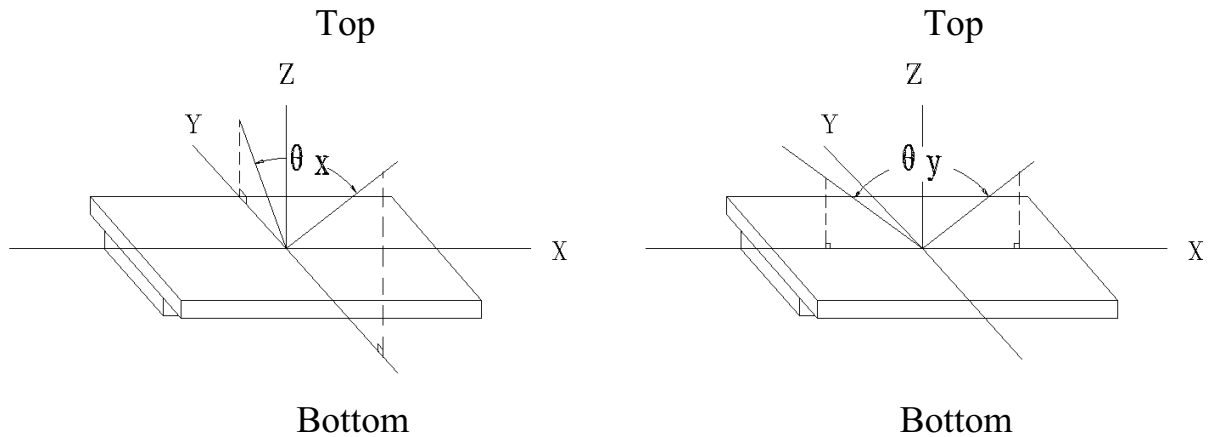

7.2.2 Definition of Contrast Ratio

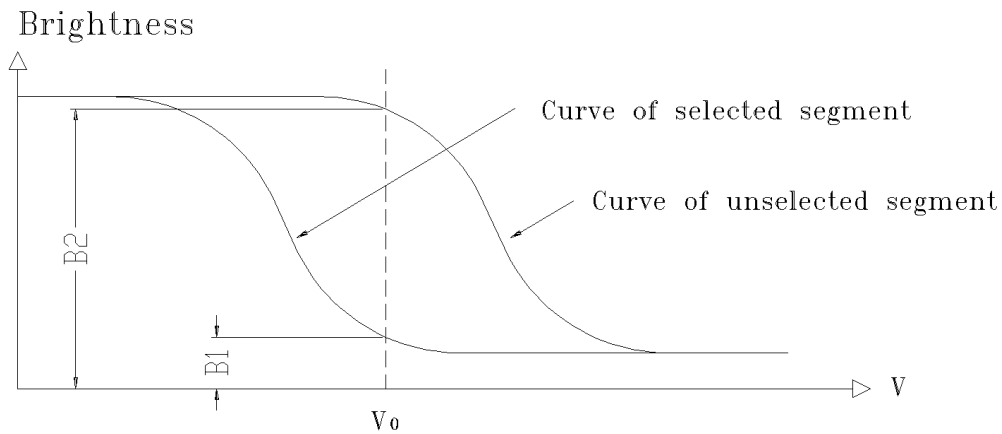

$$\text{Contrast Ratio} = B2/B1 = \frac{\text{unselected state brightness}}{\text{selected state brightness}}$$

Measuring Conditions:

- 1) Frame frequency: 100.0Hz

7.2.3 Definition of Response time

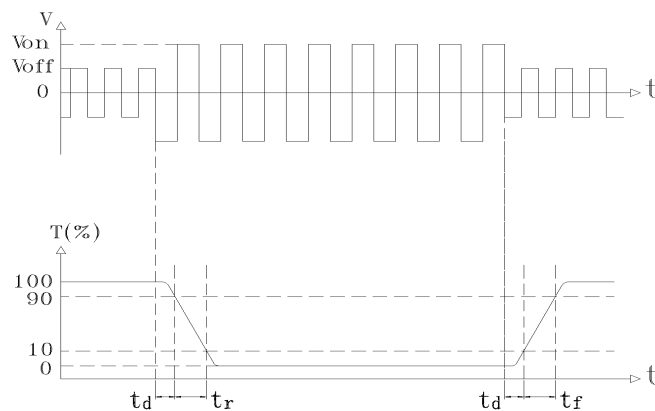

Turn on time: $t_{on} = t_d + t_r$

Turn off time: $t_{off} = t_d + t_f$

Measuring Condition:

- 1) Operating Voltage: 9.0V

- 2) Frame frequency: 100.0Hz

8.2 Failure Judgment Criterion

Criterion Item	Test Item No.									Failure Judgement Criterion
	1	2	3	4	5	6	7	8	9	
Basic Specification	√	√	√	√	√	√	√	√	√	Out of the basic Specification
Electrical specification	√	√	√	√	√					Out of the electrical specification
Mechanical Specification							√	√		Out of the mechanical specification
Optical Characteristic	√	√	√	√	√	√			√	Out of the optical specification
Note	For test item refer to 8.1									
Remark	Basic specification = Optical specification + Mechanical specification									

9 QUALITY LEVEL

Examination or Test	At $T_{amb}=25^{\circ}\text{C}$ (unless otherwise stated)	Inspection				
		Min.	Max.	Unit	IL	AQL
External Visual Inspection	Under normal illumination and eyesight condition, the distance between eyes and LCD is 25cm.	See annex A			II	Major 1.0 Minor 2.5
Display Defects	Under normal illumination and eyesight condition, display on inspection.	See annex B			II	Major 1.0 Minor 2.5
<p>Note: Major defects: Open segment or common, Short, Serious damages, Leakage Miner defects: Others Sampling standard conforms to GB2828</p>						

10 Precautions for Use of LCD Modules

10.1 Handling Precautions

10.1.1 The display panel is made of glass. Do not subject it to a mechanical shock by dropping it from a high place, etc.

10.1.2 If the display panel is damaged and the liquid crystal substance inside it leaks out, be sure not to get any in your mouth, if the substance comes into contact with your skin or clothes, promptly wash it off using soap and water.

10.1.3 Do not apply excessive force to the display surface or the adjoining areas since this may cause the color tone to vary.

10.1.4 The polarizer covering the display surface of the LCD module is soft and easily scratched. Handle this polarizer carefully.

10.1.5 If the display surface is contaminated, breathe on the surface and gently wipe it with a soft dry cloth. If still not completely clear, moisten cloth with one of the following solvents:

- Isopropyl alcohol
- Ethyl alcohol

Solvents other than those mentioned above may damage the polarizer. Especially, do not use the following:

- Water
- Ketone
- Aromatic solvents

10.1.6 Do not attempt to disassemble the LCD Module.

10.1.7 If the logic circuit power is off, do not apply the input signals.

10.1.8 To prevent destruction of the elements by static electricity, be careful to maintain an optimum work environment.

- a. Be sure to ground the body when handling the LCD Modules.
- b. Tools required for assembly, such as soldering irons, must be properly ground.
- c. To reduce the amount of static electricity generated, do not conduct assembly and other work under dry conditions.
- d. The LCD Module is coated with a film to protect the display surface. Be care when peeling off this protective film since static electricity may be generated.

10.2 Storage precautions

10.2.1 When storing the LCD modules, avoid exposure to direct sunlight or to the light of fluorescent lamps.

10.2.2 The LCD modules should be stored under the storage temperature range.

If the LCD modules will be stored for a long time, the recommend condition is:

Temperature : $0^{\circ}\text{C} \sim 40^{\circ}\text{C}$

Relatively humidity: $\leq 80\%$

10.2.3 The LCD modules should be stored in the room without acid, alkali and harmful gas.

10.3 The LCD modules should be no falling and violent shocking during transportation, and also should avoid excessive press, water, damp and sunshine.

Appendix A

Inspection items and criteria for appearance defects

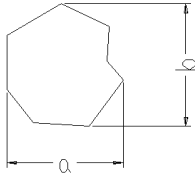
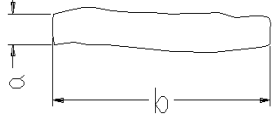
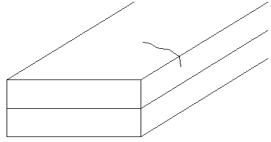
Items	Contents	Criteria		
Protective Glue		No clear defects		
Cover Tape		Covering all of the chip and no clear crimple		
Leakage		Not permitted		
Rainbow		According to the limit specimen		
Polarizer	Wrong polarizer attachment	Not permitted		
	Bubble between polarizer and glass	Not counted	Max. 3 defects allowed	
		$\phi < 0.3\text{mm}$	$0.3\text{mm} \leq \phi \leq 0.5\text{mm}$	
	Scratches of polarizer	According to the limit specimen		
Black spot (in viewing area)		Not counted	Max. 3 spots allowed	Max. 3 spots (lines) allowed
		$X < 0.20\text{mm}$	$0.20\text{mm} \leq X \leq 0.5\text{mm}$	
		$X = (a+b)/2$		
Black line (in viewing area)		Not counted	Max. 3 lines allowed	Max. 3 spots (lines) allowed
		$a < 0.02\text{mm}$	$0.02\text{mm} \leq a \leq 0.05\text{mm}$ $b \leq 2.0\text{mm}$	
Progressive cracks		Not permitted		

Appendix A

Inspection item and criteria for appearance defects (continued)

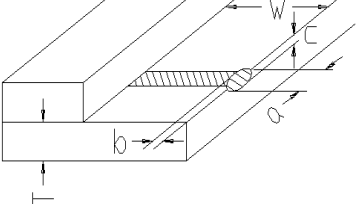
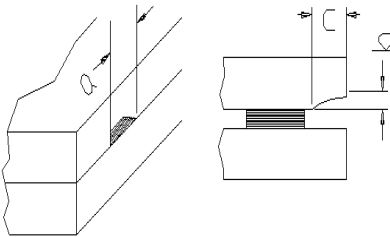
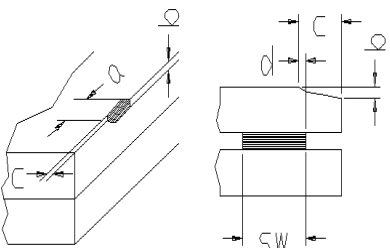
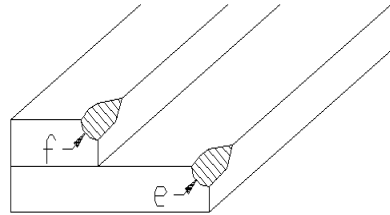
Items	Contents	Criteria					
Glass Cracks	<p>Cracks on pads</p> 	a	b	c	Max. 2 Cracks allowed	Max. 5 cracks allowed	
	$\leq 3\text{mm}$	$\leq W/5$	$\leq T/2$	$\leq 2\text{mm}$			$\leq W/5$
	<p>Cracks on contact side</p> 	a		b			Max. 2 cracks allowed
	$\leq 3\text{mm}$		$\leq T/2$				
	$\leq 2\text{mm}$		$T/2 < b < T$				
	C shall be not reach the seal area						
	<p>Cracks on non-contact side</p> 	a		b			Max. 2 cracks allowed
	$\leq 3\text{mm}$		$\leq T/2$				
	$\leq 2\text{mm}$		$T/2 < b < T$				
	$C \leq 0.5\text{mm}$						
$d \leq SW/3$							
<p>Corner cracks</p> 	$e < 2.0\text{mm}^2$ $f < 2.0\text{mm}^2$				Max. 3 cracks allowed		

Appendix B

Inspection items and criteria for display defects

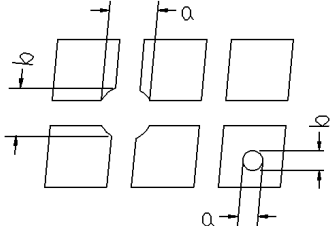
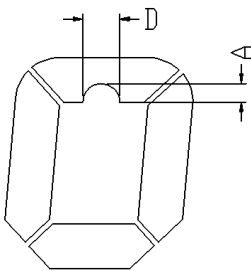
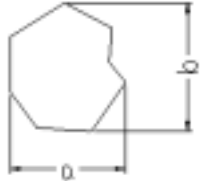
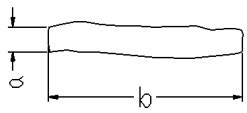
Items	Contents	Criteria			
Open segment or open common		Not permitted			
Short		Not permitted			
Wrong viewing angle		Not permitted			
Contrast ratio uneven		According to the limit specimen			
Crosstalk		According to the limit specimen			
Pin holes and cracks in segment (DOT)		Not counted	Max.3 dots allowed		Max.3 dots allowed
		$X < 0.1\text{mm}$	$0.1\text{mm} \leq X \leq 0.2\text{mm}$		
		$X = (a+b)/2$			
		Not counted	Max.2 dots allowed		
$A < 0.1\text{mm}$		$0.1\text{mm} \leq A \leq 0.2\text{mm}$ $D < 0.25\text{mm}$			
Black spot (in viewing area)		Not counted	Max.3 spots allowed		Max.3 spots (lines) allowed
		$X < 0.1\text{mm}$	$0.1\text{mm} \leq X \leq 0.2\text{mm}$		
		$X = (a+b)/2$			
Black line (in viewing area)		Not counted	Max.3 lines allowed		
		$a < 0.02\text{mm}$	$0.02\text{mm} \leq a \leq 0.05\text{mm}$		

Appendix B

Inspection items and criteria for display defects (continued)

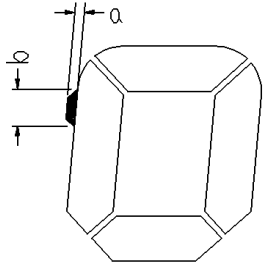
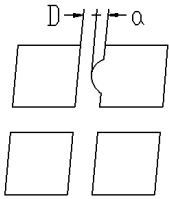
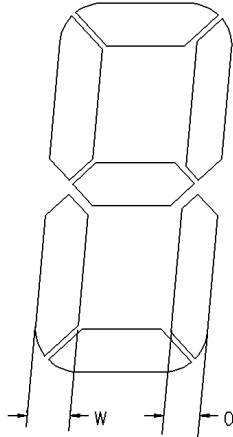
Items	Content	Criteria		
Transformation of segment		Not counted	Max. 2 defects allowed	Max.3 defects allowed
		$x < 0.1\text{mm}$	$0.1\text{mm} \leq x \leq 0.2\text{mm}$	
		$x = (a+b)/2$		
		Not counted	Max. 1 defects allowed	
		$a < 0.1\text{mm}$	$0.1\text{mm} \leq a \leq 0.2\text{mm}$ $D > 0$	
		Max.2 defects allowed $0.8W \leq a \leq 1.2W$ $a = \text{measured value of width}$ $W = \text{nominal value of width}$		