

## FAST RECOVERY RECTIFIER DIODE

- VERY HIGH REVERSE VOLTAGE CAPABILITY
- VERY LOW REVERSE RECOVERY TIME
- VERY LOW SWITCHING LOSSES
- LOW NOISE TURN-OFF SWITCHING
- INSULATED: Capacitance 15pF

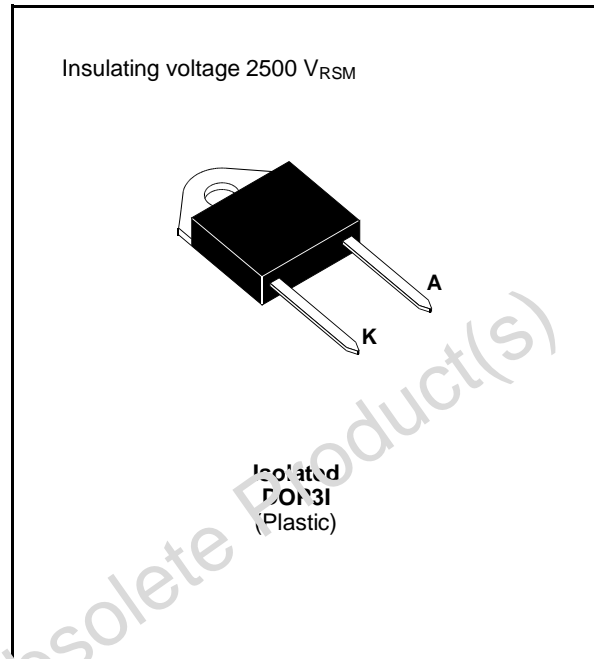

### SUITABLE APPLICATIONS

- FREE WHEELING DIODE IN CONVERTERS AND MOTOR CONTROL CIRCUITS
- RECTIFIER IN S.M.P.S.

### ABSOLUTE MAXIMUM RATINGS (limiting values)

Symbol	Parameter		Value	Unit
$V_{RRM}$	Repetitive Peak Reverse Voltage		1000	V
$V_{RSM}$	Non Repetitive Peak Reverse Voltage		1000	V
$I_{FRM}$	Repetive Peak Forward Current	$t_p \leq 10\mu s$	375	A
$I_{F(RMS)}$	RMS Forward Current		70	A
$I_{F(AV)}$	Average Forward Current	$T_c = 50^\circ C$ $\delta = 0.5$	30	A
$I_{FM}$	Surge non Repetitive Forward Current	$t_p = 10ms$ Sinusoidal	200	A
P	Power Dissipation	$T_c = 50^\circ C$	60	W
$T_{stg}$ $T_j$	Storage and Junction Temperature Range		- 40 to +150	$^\circ C$

### THERMAL RESISTANCE

Symbol	Parameter	Value	Unit
$R_{th(j-c)}$	Junction-case	1.6	$^\circ C/W$

**ELECTRICAL CHARACTERISTICS**

STATIC CHARACTERISTICS

Symbol	Test Conditions		Min.	Typ.	Max.	Unit
$I_R$	$T_j = 25^\circ\text{C}$	$V_R = V_{RRM}$			100	$\mu\text{A}$
	$T_j = 100^\circ\text{C}$				5	$\text{mA}$
$V_F$	$T_j = 25^\circ\text{C}$	$I_F = 30\text{A}$			1.9	$\text{V}$
	$T_j = 100^\circ\text{C}$				1.8	

RECOVERY CHARACTERISTICS

Symbol	Test Conditions			Min.	Typ.	Max.	Unit
$t_{rr}$	$T_j = 25^\circ\text{C}$	$I_F = 1\text{A}$	$di_F/dt = -15\text{A}/\mu\text{s}$	$V_R = 30\text{V}$		165	ns
		$I_F = 0.5\text{A}$	$I_R = 1\text{A}$	$I_{rr} = 0.25\text{A}$		70	

TURN-OFF SWITCHING CHARACTERISTICS (Without Series Inductance)

Symbol	Test Conditions		Min.	Typ.	Max.	Unit
$t_{IRM}$	$di_F/dt = -120\text{A}/\mu\text{s}$	$V_{CC} = 200\text{V}$ $I_F = 30\text{A}$ $L_p \leq 0.05\mu\text{H}$ $T_j = 100^\circ\text{C}$ See figure 11			200	ns
	$di_F/dt = -240\text{A}/\mu\text{s}$			120		
$I_{RM}$	$di_F/dt = -120\text{A}/\mu\text{s}$				19.5	A
	$di_F/dt = -240\text{A}/\mu\text{s}$			22		

TURN-OFF OVERVOLTAGE COEFFICIENT (With Series Inductance)

Symbol	Test Conditions			Min.	Typ.	Max.	Unit
$C = \frac{V_{RP}}{V_{CC}}$	$T_j = 100^\circ\text{C}$ $di_F/dt = -30\text{A}/\mu\text{s}$	$V_{CC} = 200\text{V}$ $L_p = 5\mu\text{H}$	$I_F = I_{F(AV)}$ See figure 12			4.5	

To evaluate the conduction losses use the following equations:

$$V_F = 1.47 + 0.010 I_F \quad P = 1.47 \times I_{F(AV)} + 0.010 I_{F(RMS)}^2$$

**Figure 1. Low frequency power losses versus average current**

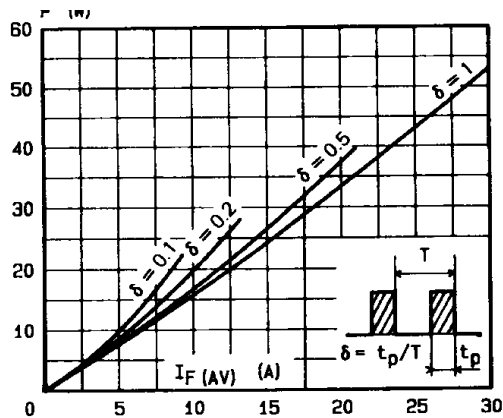

**Figure 2. Peak current versus form factor**

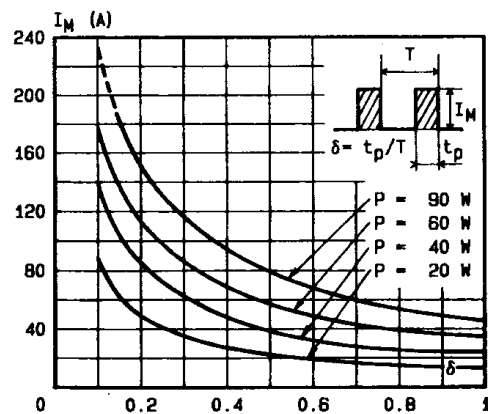

Figure 3. Non repetitive peak surge current versus overload duration

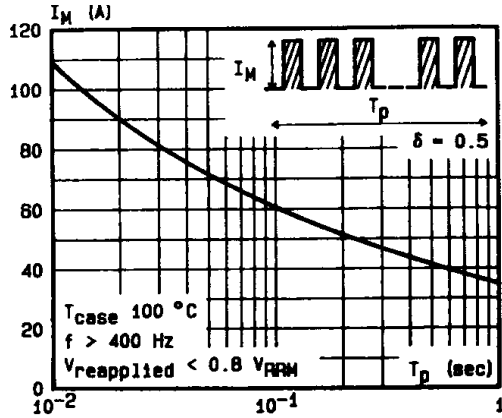

Figure 4. Thermal impedance versus pulse width

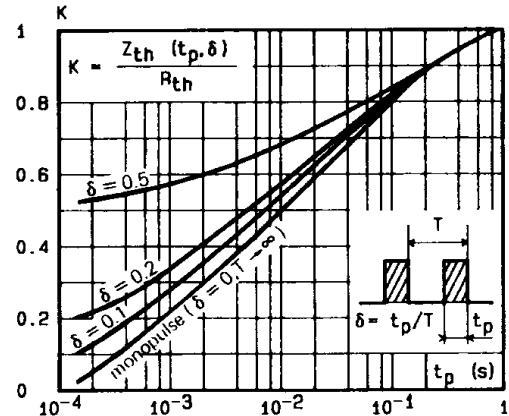

Figure 5. Voltage drop versus forward current

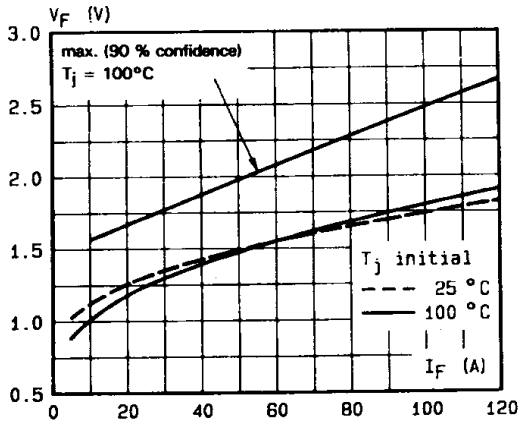

Figure 6. Recovery charge versus di\_F/dt

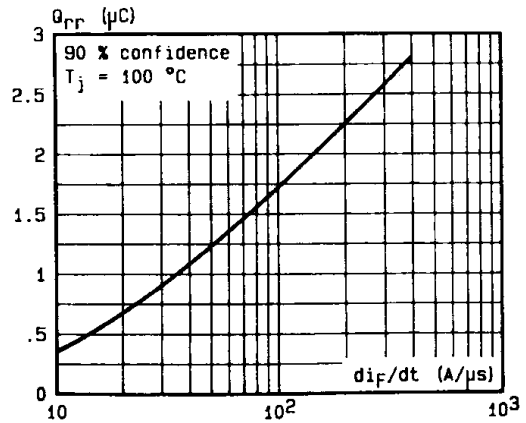

Figure 7. Recovery time versus di\_F/dt

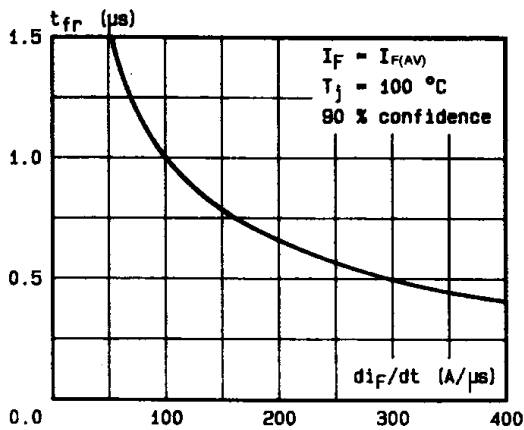

Figure 8. Peak reverse current versus di\_F/dt

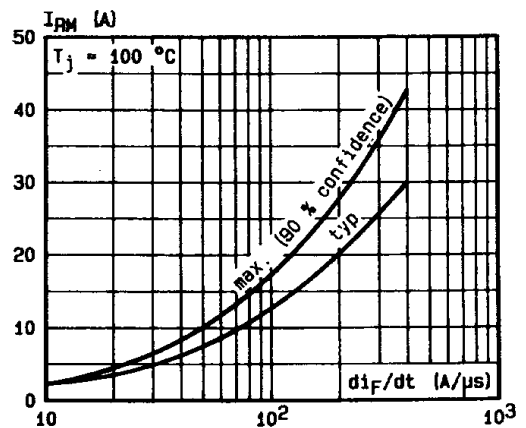

Figure 9. Peak forward voltage versus  $di_F/dt$ .

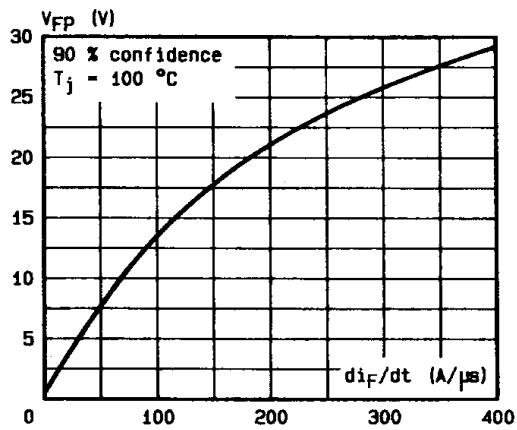

Figure 10. Dynamic parameters versus junction temperature.

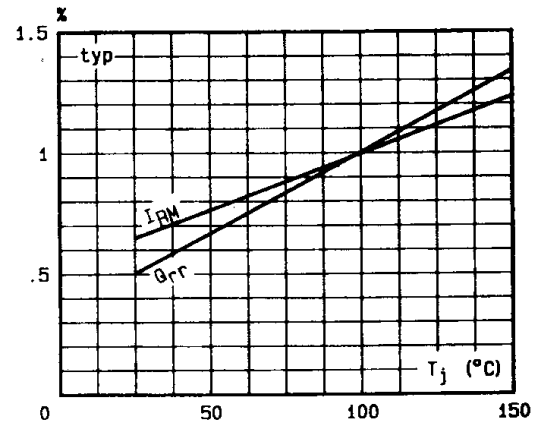

Figure 11. Turn-off switching characteristics (without series inductance).

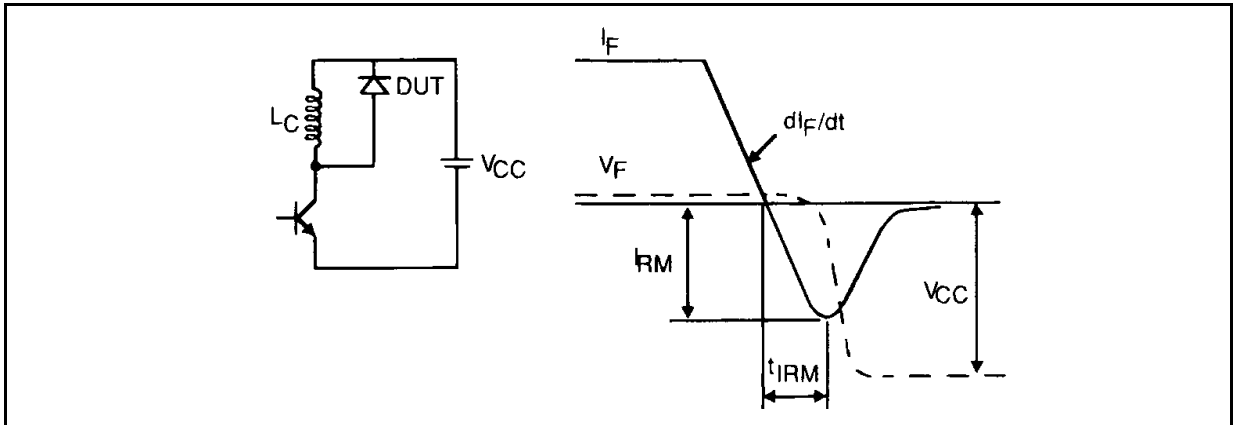
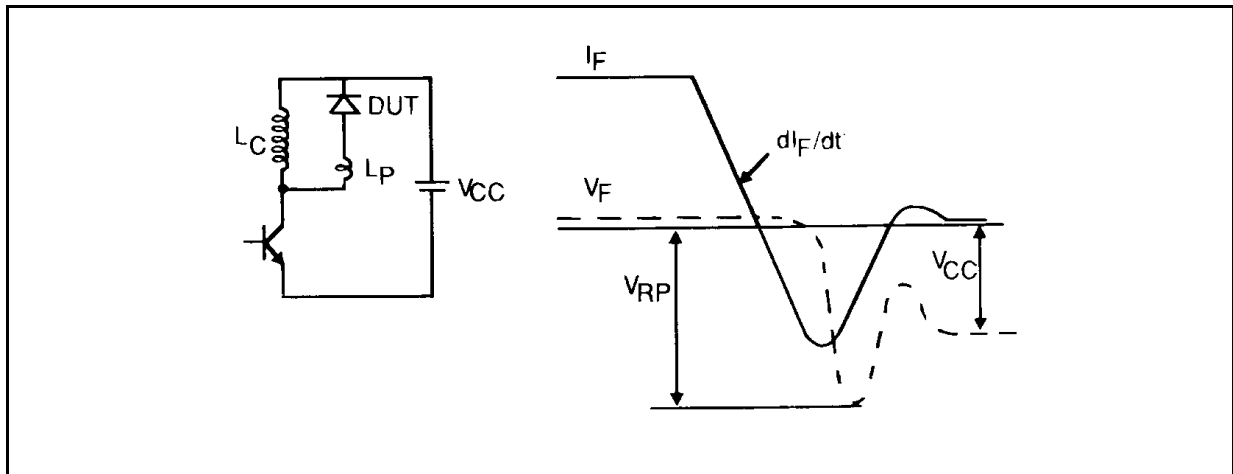
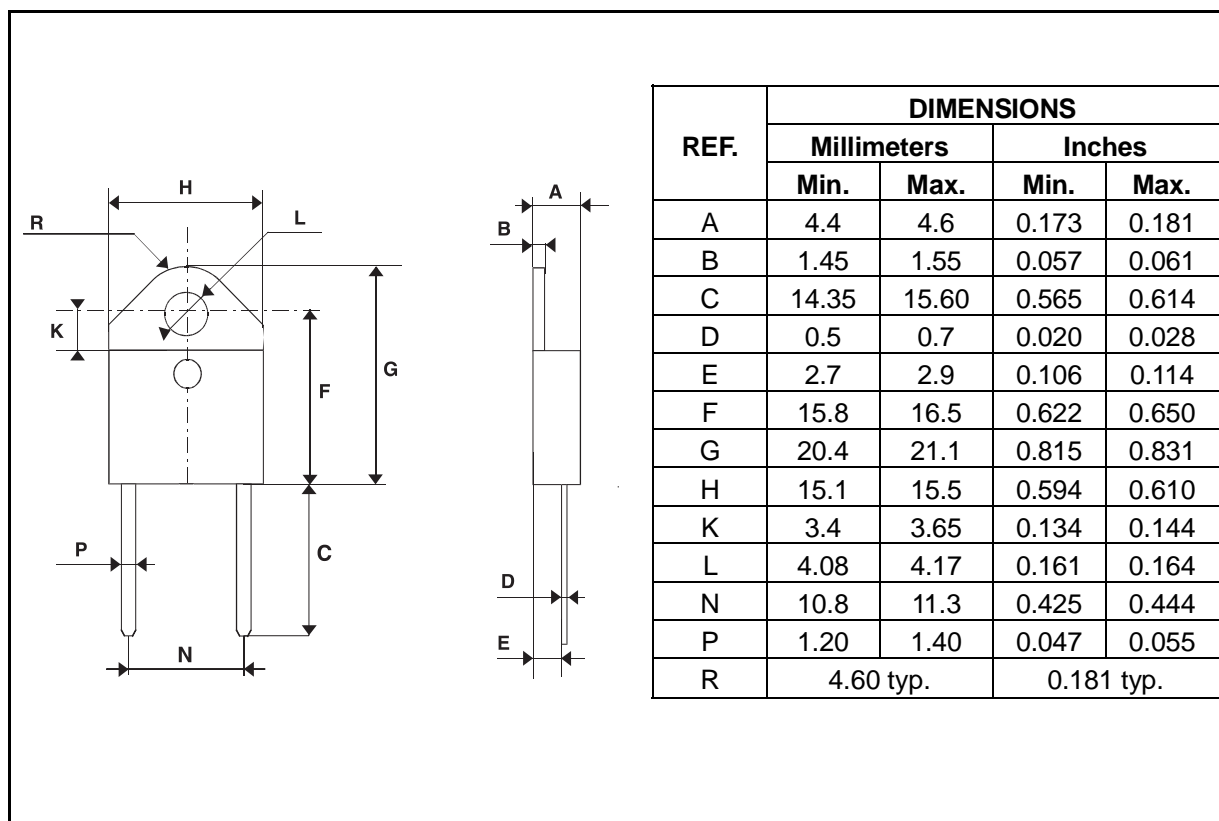

Figure 12. Turn-off switching characteristics (with series inductance)



## PACKAGE MECHANICAL DATA : Isolated DOP3I Plastic



Cooling method: by conduction (method C)  
 Marking: type number  
 Weight: 18.84g  
 Recommended torque value: 250cm. N  
 Maximum torque value: 310cm. N

Information furnished is believed to be accurate and reliable. However, STMicroelectronics assumes no responsibility for the consequences of use of such information nor for any infringement of patents or other rights of third parties which may result from its use. No license is granted by implication or otherwise under any patent or patent rights of STMicroelectronics. Specifications mentioned in this publication are subject to change without notice. This publication supersedes and replaces all information previously supplied. STMicroelectronics products are not authorized for use as critical components in life support devices or systems without express written approval of STMicroelectronics.

The ST logo is a registered trademark of STMicroelectronics  
 © 1999 STMicroelectronics - Printed in Italy - All rights reserved.

STMicroelectronics GROUP OF COMPANIES  
 Australia - Brazil - China - Finland - France - Germany - Hong Kong - India - Italy - Japan - Malaysia  
 Malta - Morocco - Singapore - Spain - Sweden - Switzerland - United Kingdom - U.S.A.

<http://www.st.com>