

0.325" PITCH SERIES SSB3

PHYSICAL PROPERTIES

HOUSING MATERIAL: Polypropylene
FLAMMABILITY: UL94V-2
COLOR: Black

TERMINAL

TERMINALS: Brass, bright acid tin over copper plating
SCREW: Steel w/ Zinc + Chromate plating
CLAMP: Steel w/ Zinc + Chromate plating

MECHANICAL

PITCH (TERMINAL SPACING): .325"
SCREW SIZE: 6-32
RECOMMENDED PCB HOLE DIA.: .062"
WIRE STRIP LENGTH: .31"
RECOMMENDED TIGHTENING TORQUE: 9 in lbs.
RECOMMENDED SCREWDRIVERS: Stanley 1006-4, Sears Craftsman 41581, Any #2 Phillips Head.
WIRE LUG WIDTH (MAX.): .265"

ELECTRICAL PROPERTIES

MAXIMUM CURRENT: 15A
OPERATING VOLTAGE: 300V
WIRE RANGE: #14-26 AWG
DIELECTRIC WITHSTAND: 4500V

ENVIRONMENTAL PROPERTIES

OPERATING TEMPERATURE RANGE: -60°C to +105°C
(-76°F to +221°F)

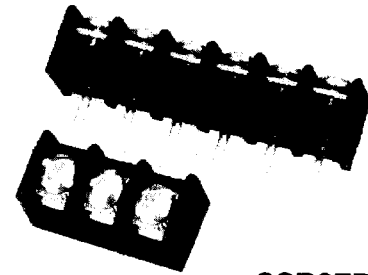

SSB3FP##0202

Dimensions

CIRCUITS (NOT POSITIONS)	C1 IN	L1 IN	C2 IN	L2 IN
02	.325	.704	.975	1.354
03	.650	1.029	1.300	1.679
04	.975	1.354	1.625	2.004
05	1.300	1.679	1.950	2.329
06	1.625	2.004	2.275	2.654
07	1.950	2.329	2.600	2.979
08	2.275	2.654	2.925	3.304
09	2.600	2.979	3.250	3.629
10	2.925	3.304	3.575	3.954
11	3.250	3.629	3.900	4.279
12	3.575	3.954	4.225	4.604
13	3.900	4.279	4.550	4.929
14	4.225	4.604	4.875	5.254
15	4.550	4.949	5.200	5.579
16	4.875	5.254	5.525	5.579
17	5.200	5.579	5.850	6.229
18	5.525	5.904	6.175	7.554
19	5.850	6.229	6.500	6.879
20	6.2175	6.554	6.825	7.204
21	6.500	6.879	7.150	7.529
22	6.825	7.204	7.475	7.854
23	7.150	7.529	7.800	8.179
24	7.475	7.854	8.125	8.504
25	7.800	8.179	8.450	8.829
26	8.125	8.504	8.775	9.154
27	8.450	8.829	9.100	9.479
28	8.775	9.154	9.425	9.804
29	9.100	9.479	9.750	10.129
30	9.425	9.804	10.075	10.454
31	9.750	10.129	10.400	10.779
32	10.075	10.454	10.725	11.104
33	10.400	10.779	11.050	11.429
34	10.725	11.104	11.375	11.754
35	11.050	11.429		
36	11.375	11.754		

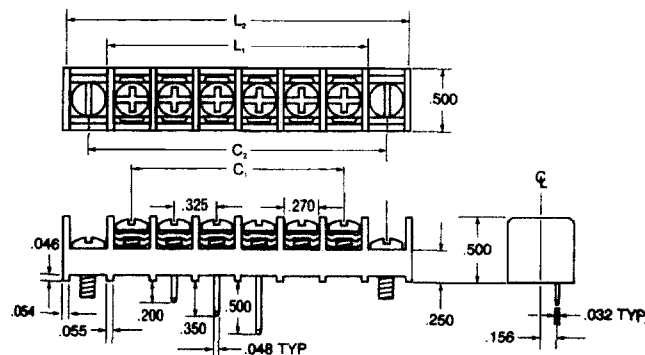
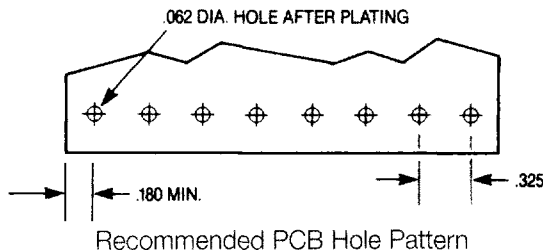

COMPUTING BARRIER BLOCK LENGTHS

DIRECT MOUNTING - Use C1 & L1 for Mounting Option "P".

END POSITION MOUNTING - Use C2 & L2 for Mounting Options "F" and "M".

BUCHANAN.



EC/98/003-01 12241/CL

LR49571

E60980

0.325" PITCH SERIES SSB3

ORDERING INFORMATION

SSB **3** **F** **P** **06** **02** **02** **Suffix**
A **B** **C** **D** **E** **F** **G** **H**

A Single Screw Barrier Block SSB

B Contact Spacing

(Center-to-Center)
3=.325 in.

C Base

F=Raised Base

D Mounting Options

F= Open end positions without end barriers

M= Open end positions with end barriers

P= All positions filled with contacts, with end barriers

T= Threaded mounting plate in each end position. End barriers removed.

E No. of Circuits (Not Positions)

02 through 36

F Terminal Style

02= Printed Circuit Pin

03= Non-Feedthrough

04= Extended Circuit Board

07= Wire Wrap

11= Right Angle Bend .29 x .12

12= Right Angle Bend .44 x .12

G Top Hardware Options

01= Bright zinc and chromate plated steel binding-head screw







02= Bright zinc and chromate plated steel screw and captive clamp - Do not order in combination with other top hardware.

10= Yellow chromate plated steel binding head screw.

11= Yellow chromate plated steel screw and captive clamp - Do not order in combination with other top hardware.

Quick-Connect Blades

(supplied with 01 screw)

	.110 wide x.020 thick	.187 wide x.020 thick
10		70= 
11		71= 
12		72= 
13		73= 
14		74= 
15		75= 

H Circuit Identification Options

Catalog Number Codes: 11 through 16. SSB blocks may be ordered with circuit identification numbers in white on the molding in six different variations. Custom markings are available on special order.

(Blank)= No circuit ID

11=	12345...
12=	...54321
13=	← 2 3 4 5 ...
14=	... 5 4 3 2 1 →
15=	12345...
16=	...54321

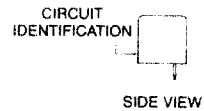
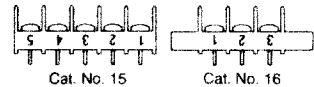
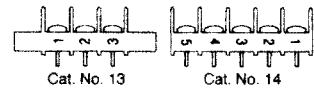
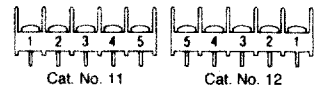

0.325" PITCH SERIES SSB3 OPTIONS

BASE

CATALOG LETTER CODE: F. Lends itself most readily to applications where direct top-to-bottom feed-through is required with no special requirement for circuit isolation on the bottom side. The most common example of this is printed circuit board mounting.

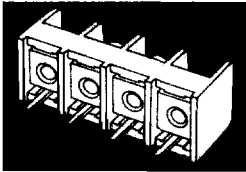

MOUNTING OPTIONS

End Position Mounting

CATALOG LETTER CODE: R. Provides a printed circuit board mounting option with top-side wire entry. Supplied with terminal option 15.

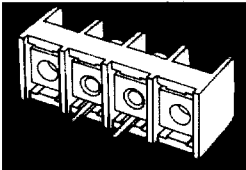

End Position Mounting Without Barriers

CATALOG LETTER CODE: F. Facilitates mounting-screw access when end sections are used for mounting.

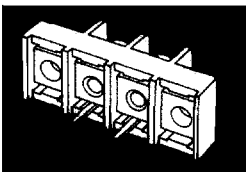

Direct Mounting:

CATALOG LETTER CODE: P. SSBs may be solder-mounted using the bottom terminals themselves, as in the case of printed circuit board applications.

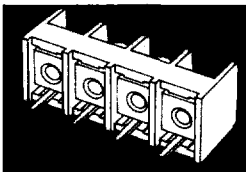

TERMINAL STYLE

Printed Circuit Pin:

CATALOG NUMBER CODE: 02. Designed specifically for mounting on .063" thick circuit board. Special, readily solderable, plating permits good fillet development in automated soldering processes.

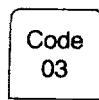
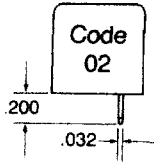

Non-Feed-Through
CATALOG NUMBER CODE: 03.



Printed Circuit Pin:
CATALOG NUMBER CODE: 04. Useful where extra length is needed, as in thicker printed circuit boards or single-wrap connections.

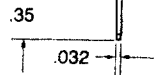

Wire Wrap
CATALOG NUMBER CODE: 07. Longer than extended circuit board terminals.

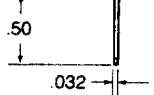

QUICK CONNECTS

CATALOG NUMBER CODES: 10 through 75. A complete selection of .187" and .110" quick-connect blades are available for connecting wire terminated with female quick connects. Single and double sided types in flat, 45° and 90° angle bends can be supplied. Material is brass with tin plating. All blades supplied with 01 screws. Various quick-connects can be combined.

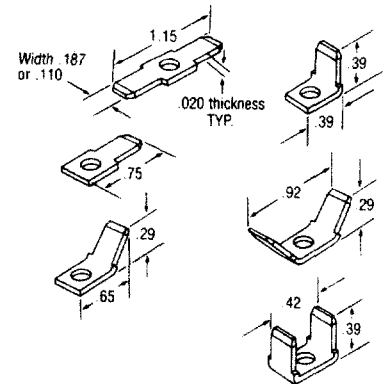

TOP HARDWARE OPTIONS

Binding Head Screws

CATALOG NUMBER CODE: 01. In most applications, binding head screws will provide excellent wire retention because of exclusive wire locking tabs. Screws are bright zinc and chromate plated steel.



Captive Clamp

CATALOG NUMBER CODE: 02. For applications requiring extra security, captive clamps under the screw heads augment the locking tabs on each contact. Screws have a unique Phi-slot design accepting either Phillips-head or straight screwdriver. Code 02 screw is Bright Zinc and Chromate plated steel.



**0.325" PITCH
SERIES SSB3
ACCESSORIES**

DESCRIPTION

STEEL BINDING HEAD SCREWS

Phil-slot, steel, bright zinc and chromate plated

CAPTIVE CLAMP SCREW

Phil-slot, steel, bright zinc and chromate plated

QUICK CONNECT BLADES

DESCRIPTION	110 WIDE		187 WIDE	
	X .020 THICK	QC10	X .020 THICK	QC70
Flat, Two-Sided	—	QC10	—	QC70
45°, Two-Sided	∨	QC11	∨	QC71
90°, Two-Sided	U	QC12	U	QC72
Flat, Single-Sided	—	QC13	—	QC73
45°, Single-Sided	∨	QC14	∨	QC74
90°, Single-Sided	L	QC15-BU	L	QC75

CATALOG NUMBER



3L01



3L02

SAFETY COVERS

Dead front protection prevents accidental contact with energized circuits. Access holes for test probes are provided over each terminal. Nylon clips are included with each cover. Covers meet UL94V-0, with 50°C temperature index. Black circuit identification optional.

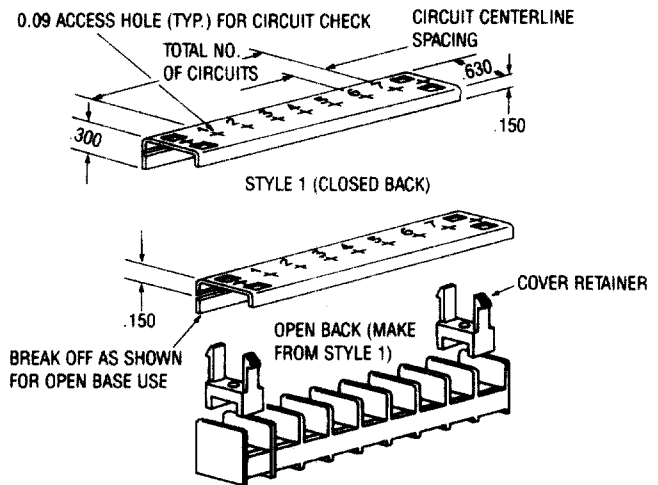

AROUND-THE-BARRIER SPADE JUMPER

J3140

40 circuits; snap apart to desired lengths. (Jumper extends .42 in horizontally from center of screw)

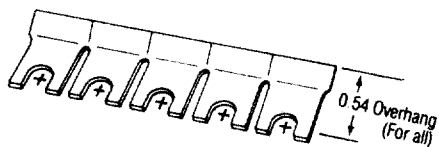

ORDERING INFORMATION

