

PRELIMINARY
 Notice: This is not a final specification.
 Some parametric limits are subject to change.

MITSUBISHI POWER MOSFET

FY5AEJ-03

HIGH-SPEED SWITCHING USE
 Nch/Pch POWER MOSFET

FY5AEJ-03



- 4V DRIVE
- V_{DS} $\pm 30V$
- $r_{DS(ON)}$ (MAX) $30/65m\Omega$
- I_D $5/-4A$

OUTLINE DRAWING

Dimensions in mm

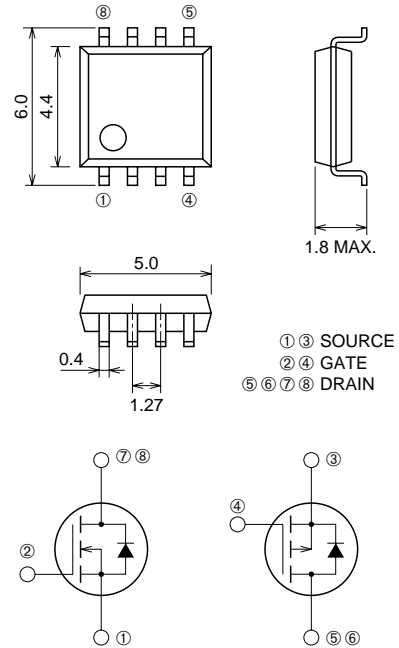

SOP-8

APPLICATION

Motor control, Lamp control, Solenoid control,
 DC-DC converter, Li-ionbattery, notebook p/c, etc

MAXIMUM RATINGS (T_c = 25°C)

Symbol	Parameter	Conditions	Ratings		Unit
			n-ch	p-ch	
V_{DS}	Drain-source voltage	$V_{GS} = 0V$	30	-30	V
V_{GSS}	Gate-source voltage	$V_{BS} = 0V$	± 20	± 20	V
I_D	Drain current		5	-4	A
I_{DM}	Drain current (Pulsed)		35	-28	A
I_{DA}	Avalanche current (Pulsed)	$L = 10\mu H$	5	-4	A
I_S	Source current		1.5	-1.5	A
I_{SM}	Source current (Pulsed)		6.0	-6.0	A
P_D	Maximum power dissipation		1.6	1.7	W
T_{ch}	Channel temperature		-55~+150		°C
T_{stg}	Storage temperature		-55~+150		°C
—	Weight	Typical value	0.07		g

Aug. 1999

PRELIMINARY
Notice: This is not a final specification.
Some parametric limits are subject to change.

ELECTRICAL CHARACTERISTICS (Tch = 25°C)

N-ch

Symbol	Parameter	Test conditions	Limits			Unit
			Min.	Typ.	Max.	
V (BR) DSS	Drain-source breakdown voltage	Id = 1mA, VGS = 0V	30	—	—	V
IGSS	Gate-source leakage current	VGS = ±20V, VDS = 0V	—	—	±0.1	μA
IDSS	Drain-source leakage current	VDS = 30V, VGS = 0V	—	—	0.1	mA
VGS (th)	Gate-source threshold voltage	Id = 1mA, VDS = 10V	1.0	1.5	2.0	V
rDS (ON)	Drain-source on-state resistance	Id = 5A, VGS = 10V	—	23	30	mΩ
rDS (ON)	Drain-source on-state resistance	Id = 2A, VGS = 4V	—	40	55	mΩ
yfs	Forward transfer admittance	Id = 5A, VDS = 10V	—	9	—	S
Ciss	Input capacitance	VDS = 10V, VGS = 0V, f = 1MHz	—	550	—	pF
Coss	Output capacitance		—	220	—	pF
Crss	Reverse transfer capacitance		—	115	—	pF
td (on)	Turn-on delay time	VDD = 15V, Id = 2A, VGS = 10V, RGEN = RGS = 50Ω	—	12	—	ns
tr	Rise time		—	20	—	ns
td (off)	Turn-off delay time		—	40	—	ns
tf	Fall time		—	40	—	ns
VSD	Source-drain voltage	IS = 1.5A, VGS = 0V	—	0.75	1.10	V
Rth (ch-a)	Thermal resistance	Channel to ambient	—	—	78.1	°C/W
trr	Reverse recovery time	IS = 1.5A, dis/dt = -50A/μs	—	100	—	ns

P-ch

Symbol	Parameter	Test conditions	Limits			Unit
			Min.	Typ.	Max.	
V (BR) DSS	Drain-source breakdown voltage	Id = 1mA, VGS = 0V	-30	—	—	V
IGSS	Gate-source leakage current	VGS = ±20V, VDS = 0V	—	—	±0.1	μA
IDSS	Drain-source leakage current	VDS = -30V, VGS = 0V	—	—	-0.1	mA
VGS (th)	Gate-source threshold voltage	Id = -1mA, VDS = -10V	-1.5	-2.0	-2.5	V
rDS (ON)	Drain-source on-state resistance	Id = -4A, VGS = -10V	—	50	65	mΩ
rDS (ON)	Drain-source on-state resistance	Id = -2A, VGS = -4V	—	90	135	mΩ
yfs	Forward transfer admittance	Id = -4A, VDS = -10V	—	6	—	S
Ciss	Input capacitance	VDS = -10V, VGS = 0V, f = 1MHz	—	870	—	pF
Coss	Output capacitance		—	230	—	pF
Crss	Reverse transfer capacitance		—	110	—	pF
td (on)	Turn-on delay time	VDD = -15V, Id = -2A, VGS = -10V, RGEN = RGS = 50Ω	—	10	—	ns
tr	Rise time		—	10	—	ns
td (off)	Turn-off delay time		—	60	—	ns
tf	Fall time		—	30	—	ns
VSD	Source-drain voltage	IS = -1.5A, VGS = 0V	—	-0.88	-1.20	V
Rth (ch-a)	Thermal resistance	Channel to ambient	—	—	73.5	°C/W
trr	Reverse recovery time	IS = 1.5A, dis/dt = 50A/μs	—	100	—	ns

PRELIMINARY
 Notice: This is not a final specification.
 Some parametric limits are subject to change.

PERFORMANCE CURVES (N-ch)

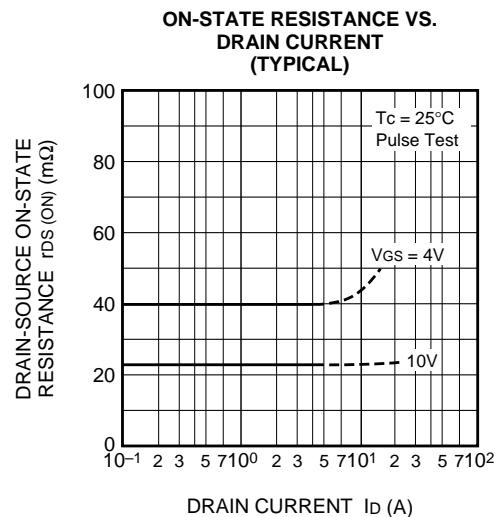
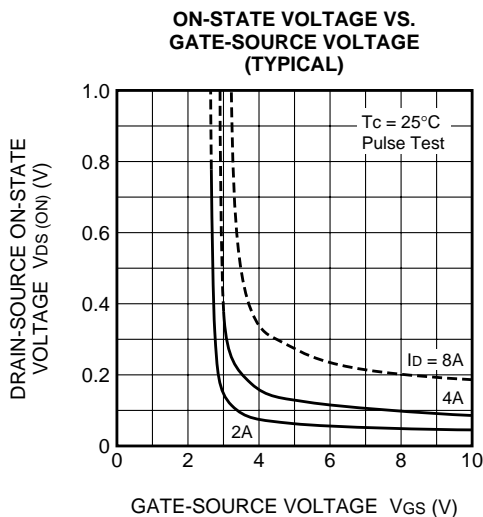
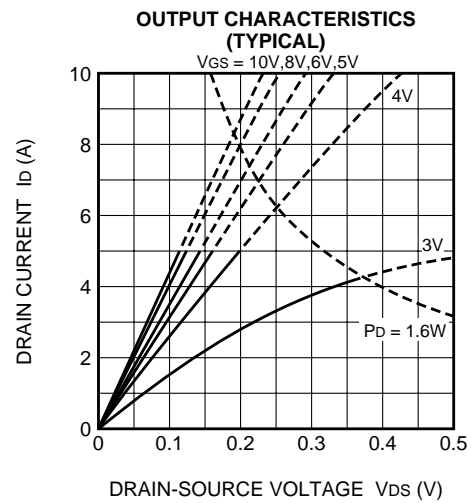
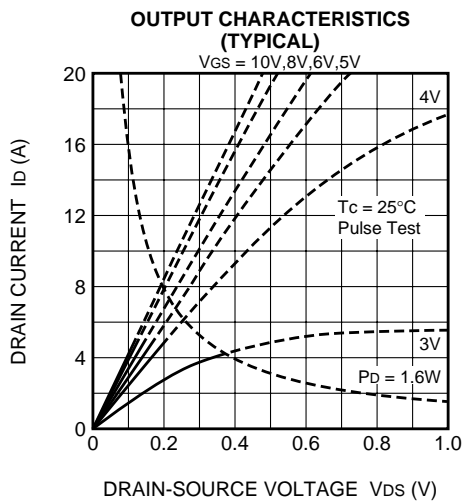
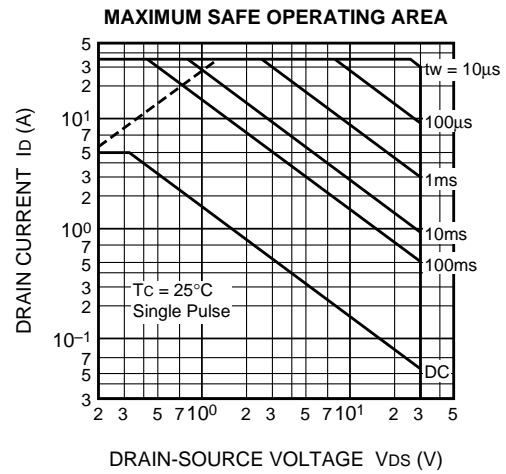
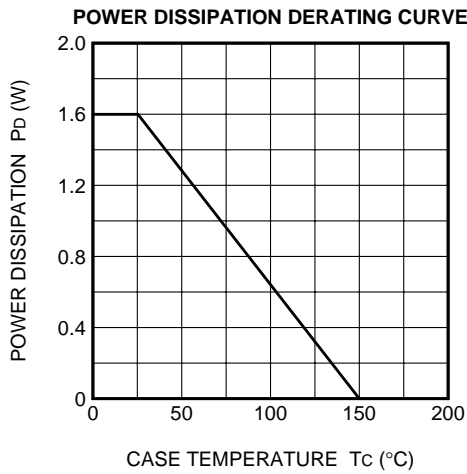

PRELIMINARY
 Notice: This is not a final specification.
 Some parametric limits are subject to change.

TRANSFER CHARACTERISTICS (TYPICAL)

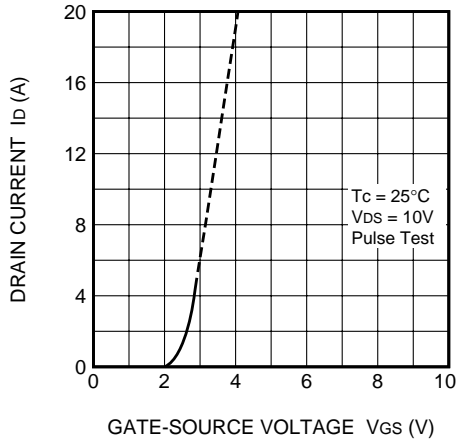

FORWARD TRANSFER ADMITTANCE VS. DRAIN CURRENT (TYPICAL)

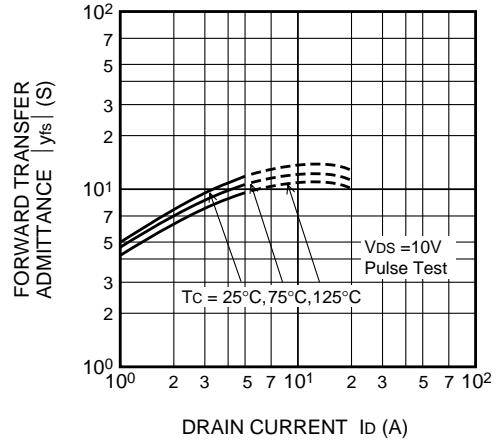

CAPACITANCE VS. DRAIN-SOURCE VOLTAGE (TYPICAL)

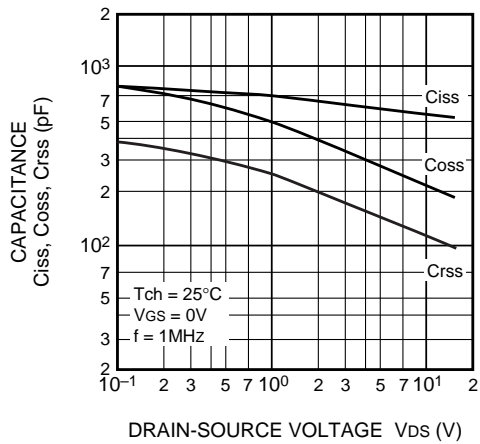

SWITCHING CHARACTERISTICS (TYPICAL)

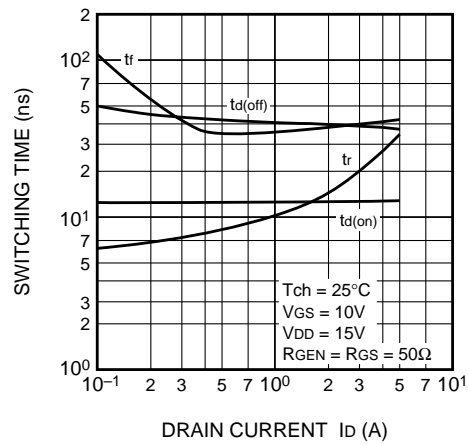

GATE-SOURCE VOLTAGE VS. GATE CHARGE (TYPICAL)

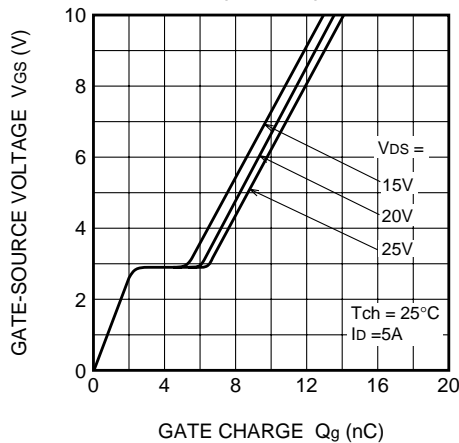

SOURCE-DRAIN DIODE FORWARD CHARACTERISTICS (TYPICAL)

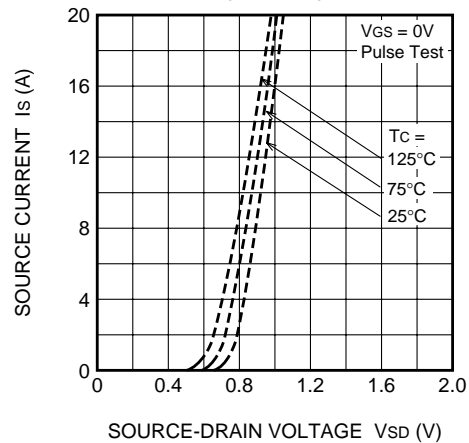

PRELIMINARY
Notice: This is not a final specification.
Some parametric limits are subject to change.

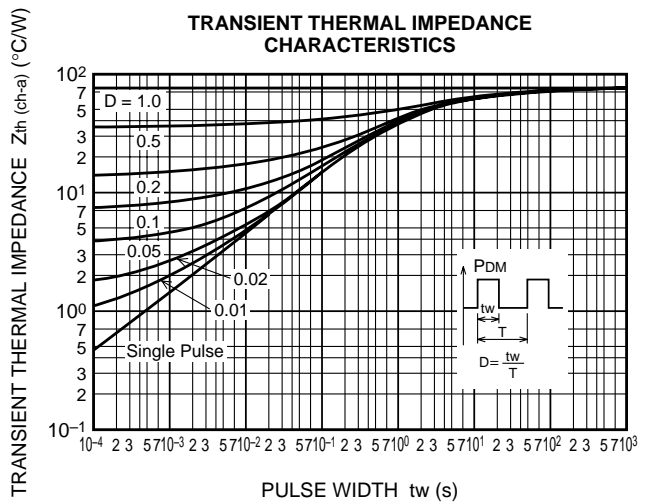
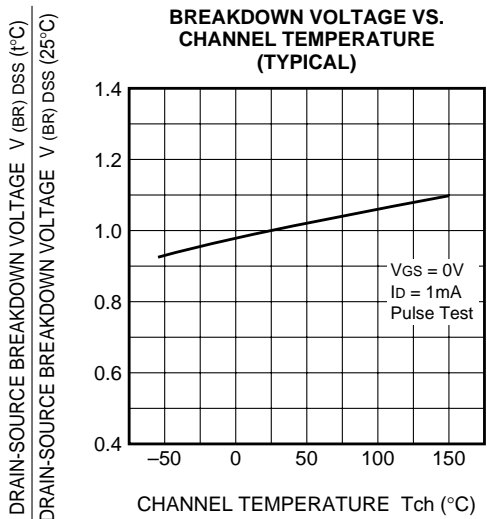
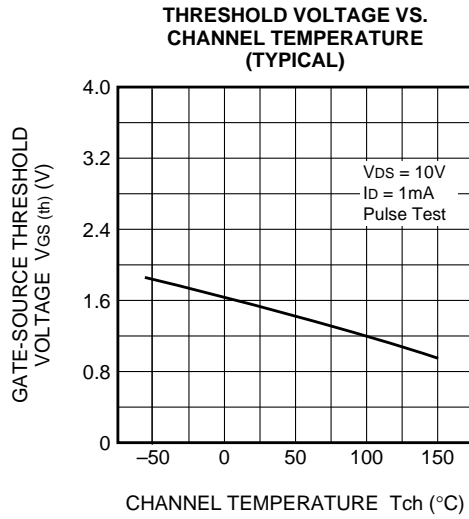
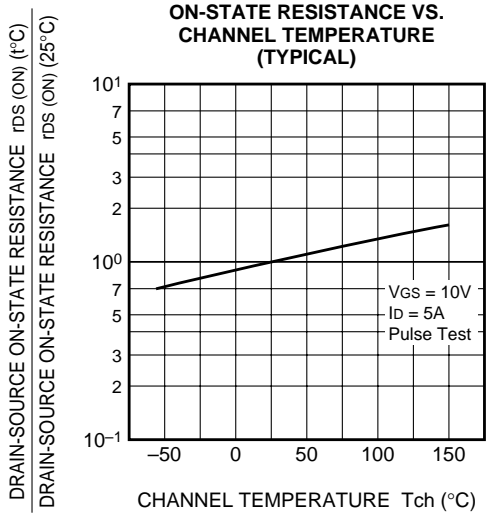

PRELIMINARY
 Notice: This is not a final specification.
 Some parametric limits are subject to change.

PERFORMANCE CURVES (P-ch)

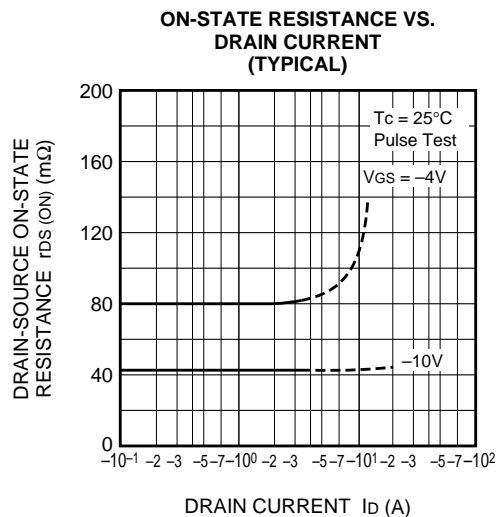
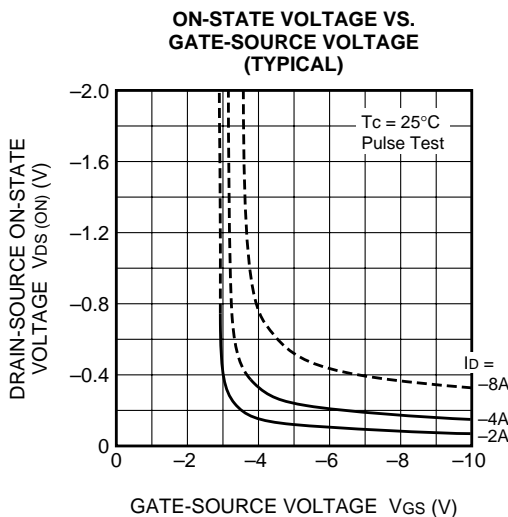
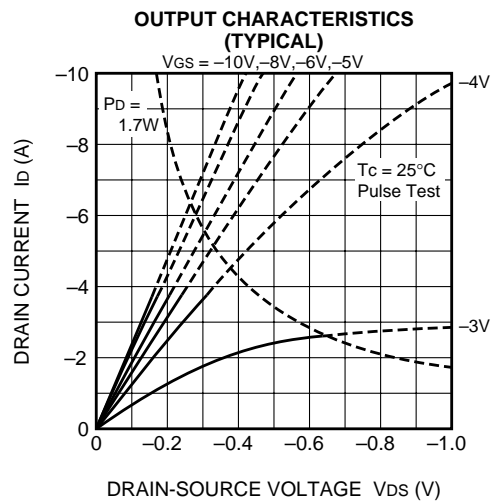
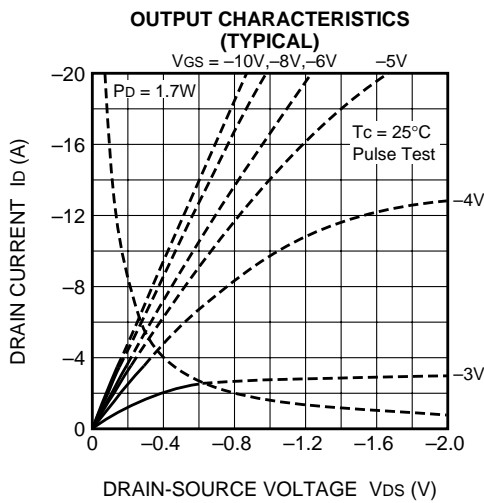
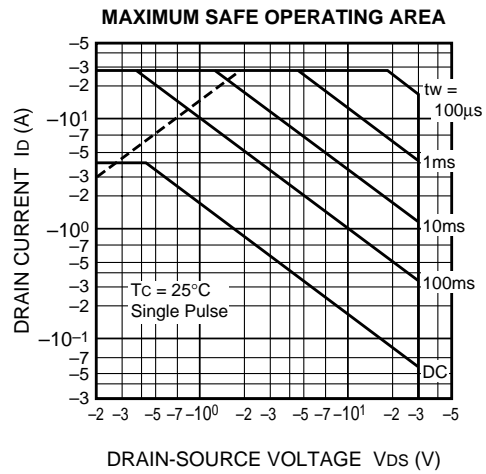
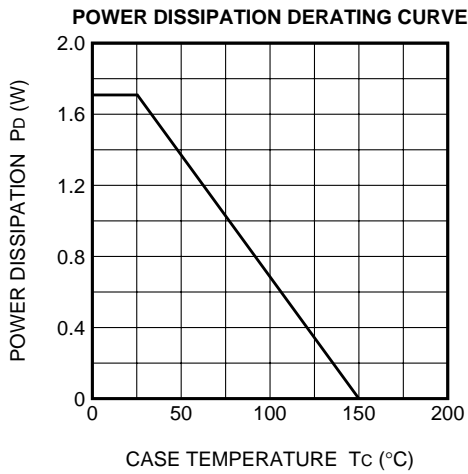

PRELIMINARY
 Notice: This is not a final specification.
 Some parametric limits are subject to change.

TRANSFER CHARACTERISTICS (TYPICAL)

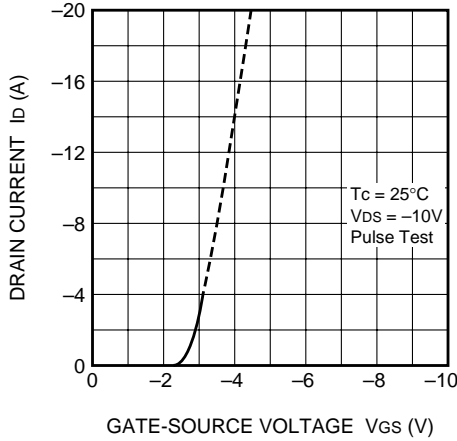

FORWARD TRANSFER ADMITTANCE VS. DRAIN CURRENT (TYPICAL)

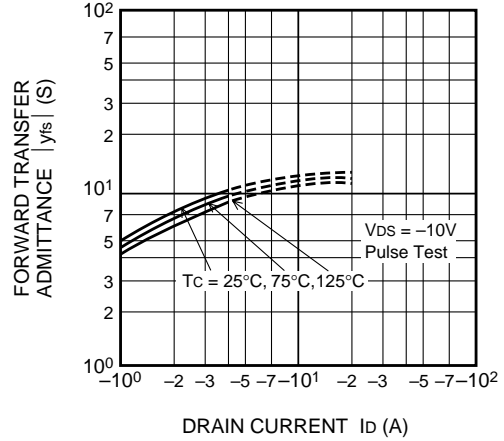

CAPACITANCE VS. DRAIN-SOURCE VOLTAGE (TYPICAL)

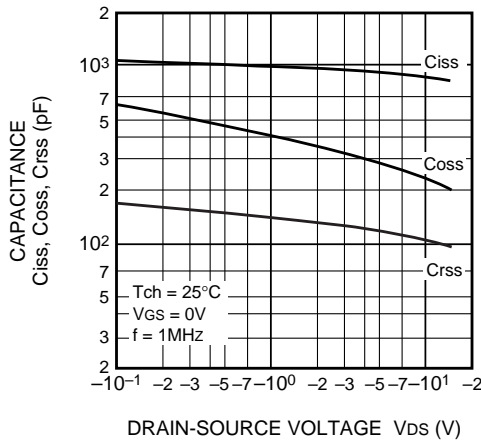

SWITCHING CHARACTERISTICS (TYPICAL)

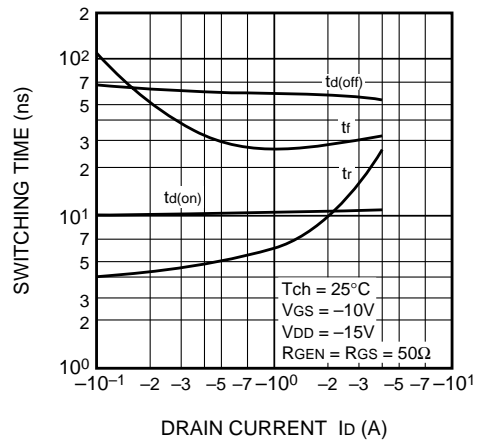

GATE-SOURCE VOLTAGE VS. GATE CHARGE (TYPICAL)

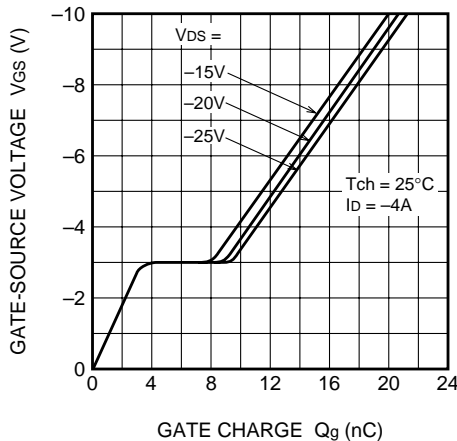

SOURCE-DRAIN DIODE FORWARD CHARACTERISTICS (TYPICAL)

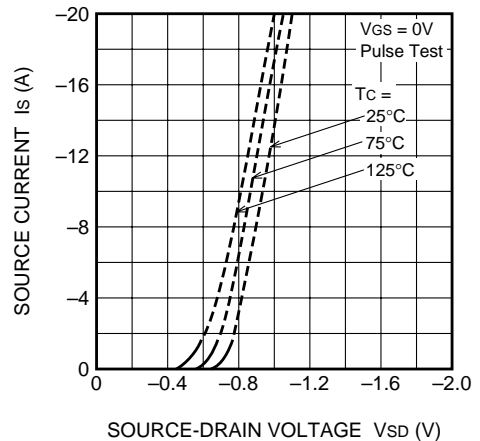

PRELIMINARY
 Notice: This is not a final specification.
 Some parametric limits are subject to change.

