



UTP45N02

Power MOSFET

N-CHANNEL ENHANCEMENT MODE

DESCRIPTION

As N-Channel power MOSFETs the **UTP45N02** is designed for use in applications such as switching regulators, switching converters, motor drivers and relay drivers.

FEATURES

- * 45A, 20V
- * $R_{DS(ON)} = 0.022\Omega$
- * Temperature compensating PSPICE model
- * Be driven directly from CMOS, NMOS, and TTL circuits
- * Peak current vs. pulse width curve

SYMBOL

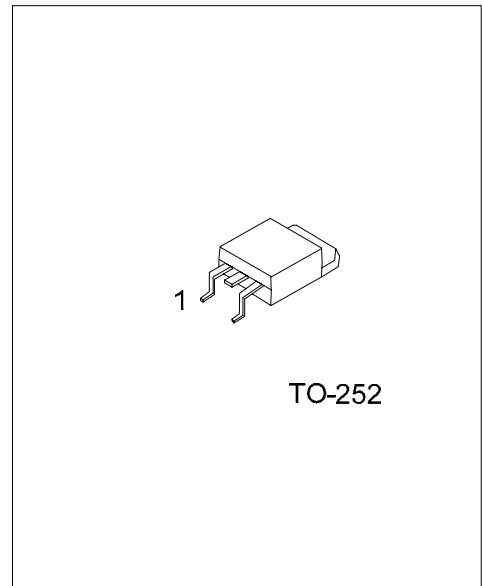
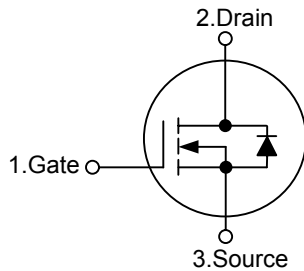

*Pb-free plating product number: UTP45N02L

ORDERING INFORMATION

Ordering Number		Package	Pin Assignment			Packing
Normal	Lead Free Plating		1	2	3	
UTP45N02-TN3-R	UTP45N02L-TN3-R	TO-252	G	D	S	Tape Reel
UTP45N02-TN3-T	UTP45N02L-TN3-T	TO-252	G	D	S	Tube

<p>UTP45N02L-TN3-R</p>	<p>(1) R: Tape Reel, T: Tube</p> <p>(2) TN3: TO-252</p> <p>(3) L: Lead Free Plating, Blank: Pb/Sn</p>
------------------------	---

■ ABSOLUTE MAXIMUM RATINGS (Ta = 25 , unless otherwise specified)

PARAMETER	SYMBOL	RATINGS	UNIT
Drain-Source Voltage	V _{DSS}	20	V
Gate-Source Voltage	V _{GSS}	±10	V
Continuous Drain Current	I _D	45	A
Power Dissipation Derate Above 25	P _D	90 0.606	W W/
Junction Temperature	T _J	+175	
Storage Temperature	T _{STG}	-55 ~ +175	

Note: Absolute maximum ratings are those values beyond which the device could be permanently damaged.
Absolute maximum ratings are stress ratings only and functional device operation is not implied.

■ THERMAL DATA

PARAMETER	SYMBOL	MIN	TYP	MAX	UNIT
Junction to Ambient	θ _{JA}			80	/W
Junction to Case	θ _{JC}			1.65	/W

■ ELECTRICAL CHARACTERISTICS (T_c =25°C, unless otherwise specified)

PARAMETER	SYMBOL	TEST CONDITIONS	MIN	TYP	MAX	UNIT
OFF CHARACTERISTICS						
Drain-to-Source Breakdown Voltage	BV _{DSS}	V _{GS} =0V, I _D =250 μA	20			V
Zero Gate Voltage Drain Current	I _{DSS}	V _{DS} =20V, V _{GS} =0 V			1	μA
Gate-to-Source Leakage Current	I _{GSS}	V _{GS} = ±10 V			±100	nA
ON CHARACTERISTICS						
Gate to Source Threshold Voltage	V _{GS(TH)}	V _{DS} =V _{GS} , I _D =250 μA	1		2	V
Drain-to-Source On Resistance	R _{DS(ON)}	V _{GS} = 5V, I _D =45 A			0.022	Ω
DYNAMIC PARAMETERS						
Input Capacitance	C _{ISS}	V _{DS} =15 V, V _{GS} =0V, f=1MHz		1300		pF
Output Capacitance	C _{OSS}			724		
Reverse Transfer Capacitance	C _{RSS}			250		
SWITCHING PARAMETERS						
Turn-ON Time	t _{ON}	V _{GS} =5 V, V _{DD} =15 V, I _D = 45 A, R _{GS} = 5 , R _L = 0.33			260	ns
Turn-ON Delay Time	t _{D(ON)}			15		
Turn-ON Rise Time	t _R			160		
Turn-OFF Delay Time	t _{D(OFF)}			20		
Turn-OFF Fall-Time	t _F			20		
Turn-OFF Time	t _{OFF}				60	
Total Gate Charge	Q _G	V _{GS} =0V~10V	V _{DD} = 16V, I _D =45A, R _L = 0.35Ω	50	60	nC
Gate-Source Charge	Q _{GS}	V _{GS} =0V ~ 5 V		30	36	
Gate-Drain Charge	Q _{GD}	V _{GS} =0V~ 1 V		1.5	1.8	
SOURCE-DRAIN DIODE RATINGS AND CHARACTERISTICS						
Drain-Source Diode Forward Voltage	V _{SD}	I _{SD} =45 A		1.5		V
Reverse Recovery Time	t _{RR}	I _{SD} = 45 A, dI _{SD} /dt = 100 A/μs		125		ns

TYPICAL CHARACTERISTICS

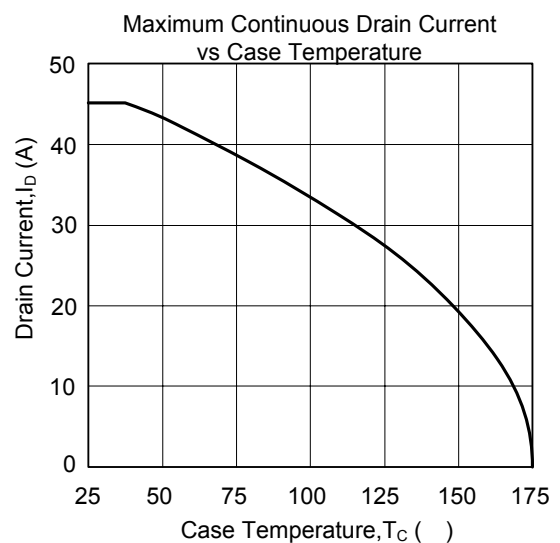
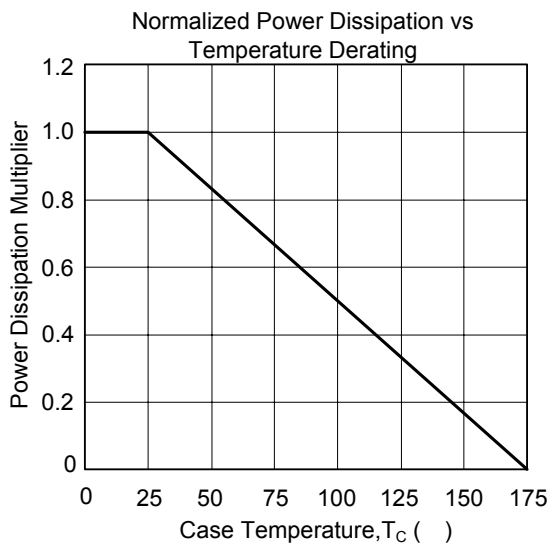
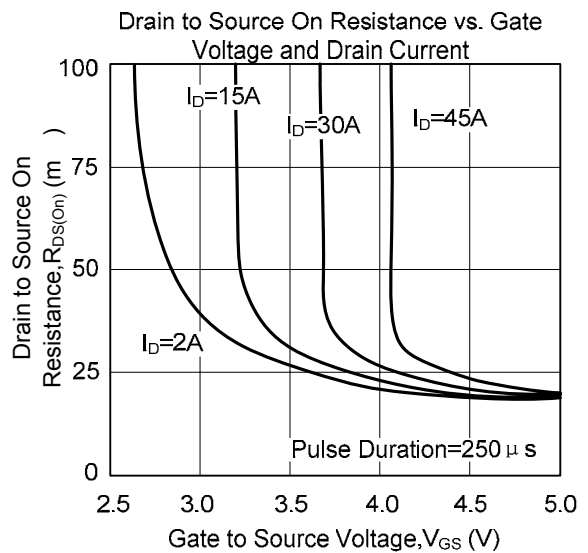
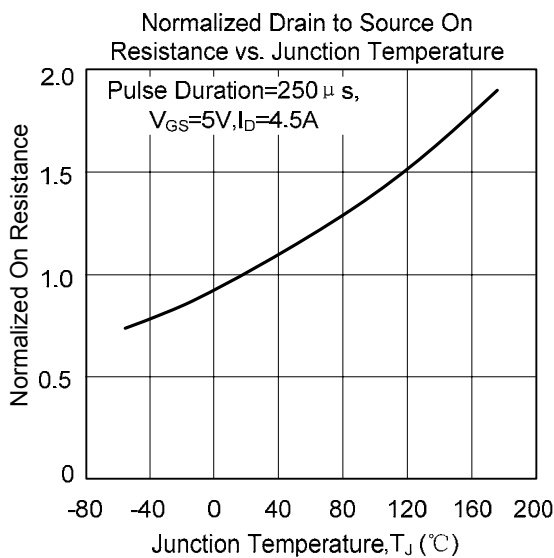
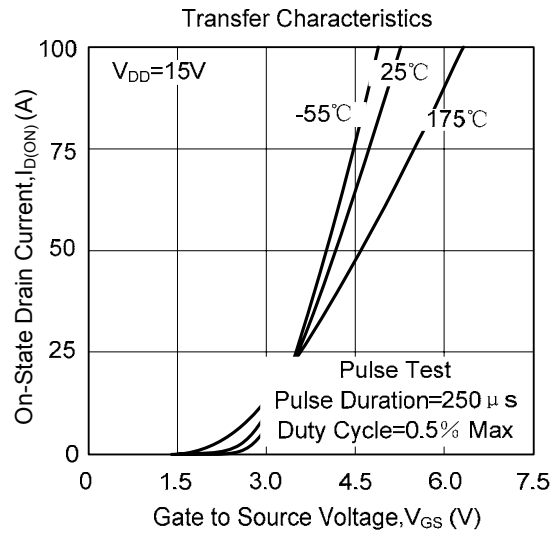
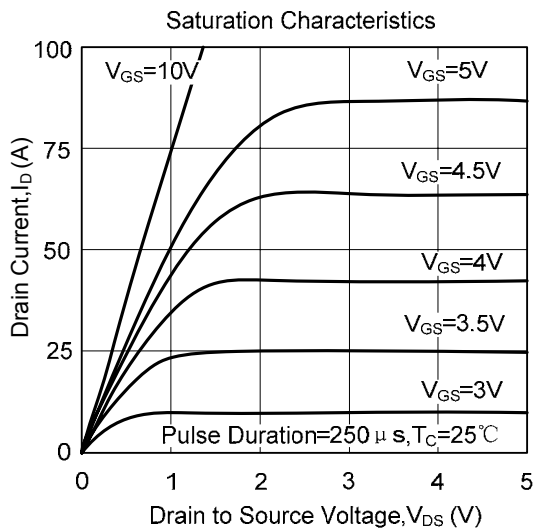

TYPICAL CHARACTERISTICS(Cont.)

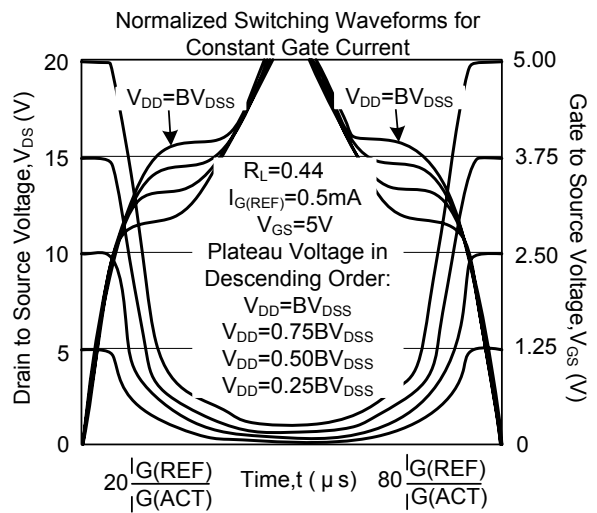
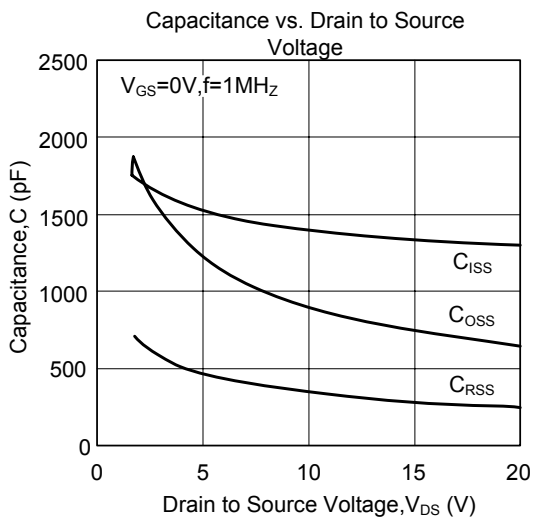
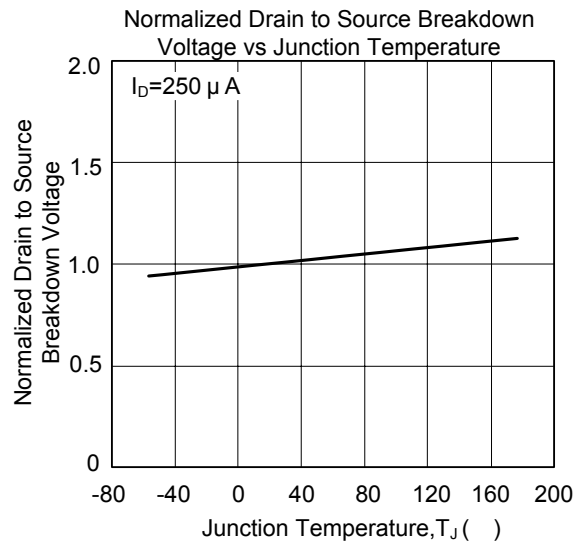
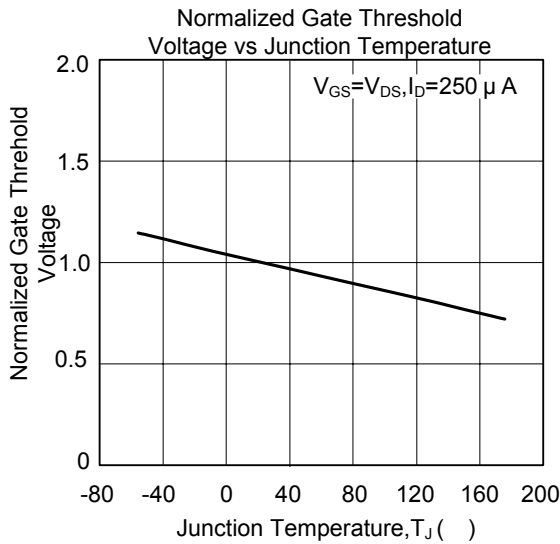
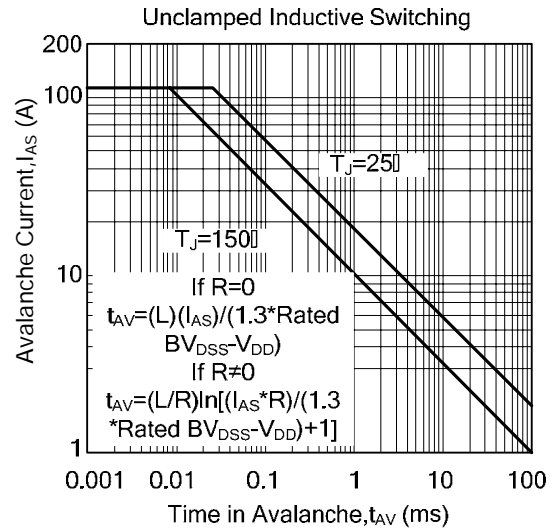
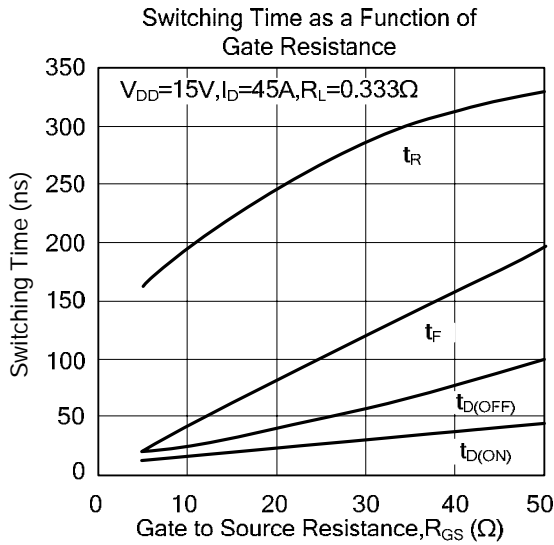

■ TYPICAL CHARACTERISTICS(Cont.)

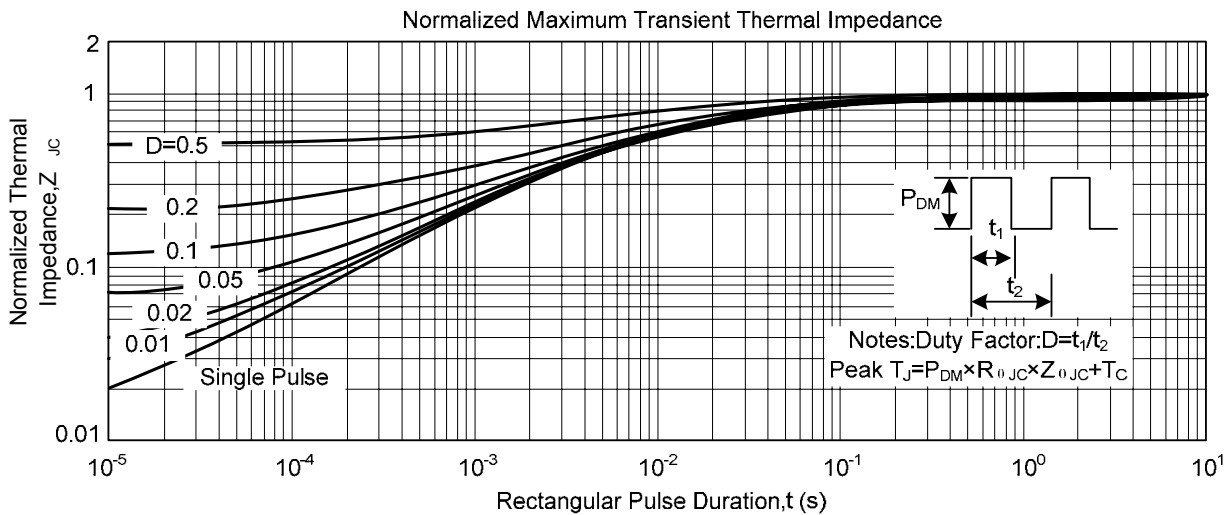
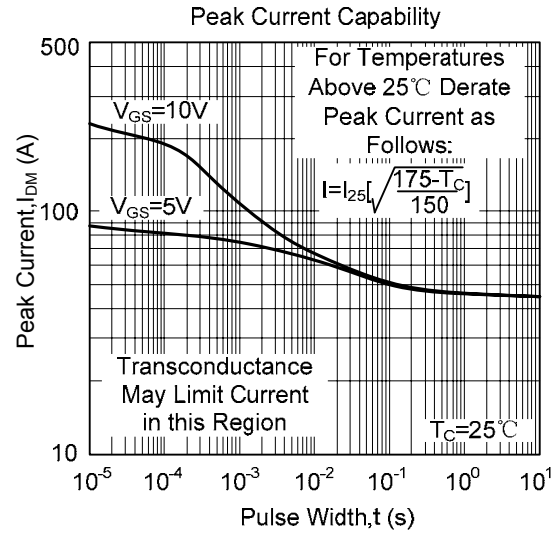
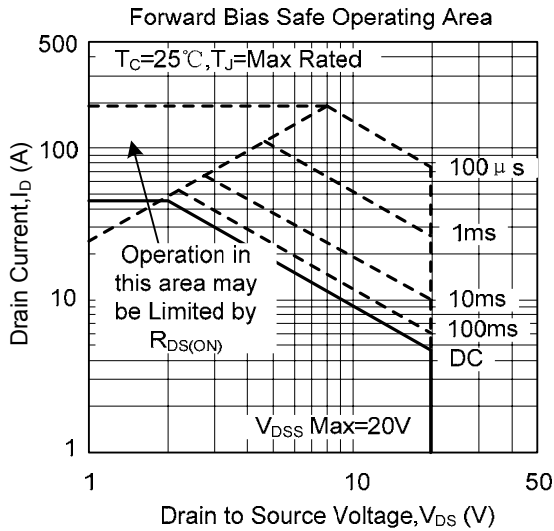

UTC assumes no responsibility for equipment failures that result from using products at values that exceed, even momentarily, rated values (such as maximum ratings, operating condition ranges, or other parameters) listed in products specifications of any and all UTC products described or contained herein. UTC products are not designed for use in life support appliances, devices or systems where malfunction of these products can be reasonably expected to result in personal injury. Reproduction in whole or in part is prohibited without the prior written consent of the copyright owner. The information presented in this document does not form part of any quotation or contract, is believed to be accurate and reliable and may be changed without notice.