



## P-Channel 100-V (D-S) MOSFET

### PRODUCT SUMMARY

$V_{DS}$ (V)	$R_{DS(on)}$ ( $\Omega$ )	$I_D$ (A) <sup>c</sup>	$Q_g$ (Typ.)
- 100	0.043 at $V_{GS} = - 10$ V	- 36	54 nC
	0.048 at $V_{GS} = - 4.5$ V	- 34.4	

### FEATURES

- Halogen-free According to IEC 61249-2-21 Definition
- TrenchFET<sup>®</sup> Power MOSFET
- 100 %  $R_g$  Tested
- Compliant to RoHS Directive 2002/95/EC



RoHS  
COMPLIANT  
HALOGEN  
FREE

### APPLICATIONS

- LCD Inverter
- Backlighting

TO-220AB

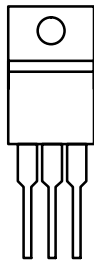

G D S

Top View

Drain connected to Tab

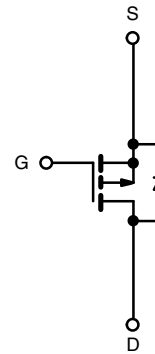

P-Channel MOSFET

Ordering Information: SUP40P10-43-GE3 (Lead (Pb)-free and Halogen-free)

### ABSOLUTE MAXIMUM RATINGS $T_C = 25$ °C, unless otherwise noted

Parameter	Symbol	Limit	Unit	
Drain-Source Voltage	$V_{DS}$	- 100	V	
Gate-Source Voltage	$V_{GS}$	$\pm 20$		
Continuous Drain Current ( $T_J = 150$ °C) <sup>c</sup>	$I_D$	$T_C = 25$ °C	- 36	A
		$T_C = 125$ °C	- 16	
Pulsed Drain Current	$I_{DM}$	- 40		
Avalanche Current	$I_{AS}$	- 35		
Single Pulse Avalanche Energy <sup>a</sup>	$E_{AS}$	61	mJ	
Power Dissipation	$P_D$	$T_C = 25$ °C	125 <sup>b</sup>	W
		$T_A = 25$ °C	2.0	
Operating Junction and Storage Temperature Range	$T_J, T_{stg}$	- 55 to 150	°C	

### THERMAL RESISTANCE RATINGS

Parameter	Symbol	Limit	Unit
Junction-to-Ambient Free Air	$R_{thJA}$	62	°C/W
Junction-to-Case	$R_{thJC}$	1.0	

Notes:

a. Duty cycle  $\leq 1$  %.

b. See SOA curve for voltage derating.

SPECIFICATIONS $T_J = 25\text{ }^\circ\text{C}$ , unless otherwise noted						
Parameter	Symbol	Test Conditions	Min.	Typ.	Max.	Unit
<b>Static</b>						
Drain-Source Breakdown Voltage	$V_{DS}$	$V_{GS} = 0\text{ V}, I_D = -250\text{ }\mu\text{A}$	-100			V
Gate-Threshold Voltage	$V_{GS(th)}$	$V_{DS} = V_{GS}, I_D = -250\text{ }\mu\text{A}$	-1		-3	
$V_{DS}$ Temperature Coefficient	$\Delta V_{DS}/T_J$	$I_D = -250\text{ }\mu\text{A}$		-109		mV/°C
$V_{GS(th)}$ Temperature Coefficient	$\Delta V_{GS(th)}/T_J$	$I_D = -250\text{ }\mu\text{A}$		5.9		
Gate-Body Leakage	$I_{GSS}$	$V_{DS} = 0\text{ V}, V_{GS} = \pm 20\text{ V}$			$\pm 100$	nA
Zero Gate Voltage Drain Current	$I_{DSS}$	$V_{DS} = -100\text{ V}, V_{GS} = 0\text{ V}$			-1	$\mu\text{A}$
		$V_{DS} = -100\text{ V}, V_{GS} = 0\text{ V}, T_J = 125\text{ }^\circ\text{C}$			-50	
		$V_{DS} = -100\text{ V}, V_{GS} = 0\text{ V}, T_J = 150\text{ }^\circ\text{C}$			-200	
On-State Drain Current <sup>a</sup>	$I_{D(on)}$	$V_{DS} = -5\text{ V}, V_{GS} = -10\text{ V}$	-40			A
Drain-Source On-State Resistance <sup>a</sup>	$R_{DS(on)}$	$V_{GS} = -10\text{ V}, I_D = -10\text{ A}$		0.036	0.043	$\Omega$
		$V_{GS} = -10\text{ V}, I_D = -10\text{ A}, T_J = 125\text{ }^\circ\text{C}$			0.078	
		$V_{GS} = -10\text{ V}, I_D = -10\text{ A}, T_J = 150\text{ }^\circ\text{C}$			0.088	
		$V_{GS} = -4.5\text{ V}, I_D = -8\text{ A}$		0.040	0.048	
Forward Transconductance <sup>a</sup>	$g_{fs}$	$V_{DS} = -15\text{ V}, I_D = -10\text{ A}$		38		S
<b>Dynamic<sup>b</sup></b>						
Input Capacitance	$C_{iss}$	$V_{GS} = 0\text{ V}, V_{DS} = -50\text{ V}, f = 1\text{ MHz}$		4600		$\mu\text{F}$
Output Capacitance	$C_{oss}$			230		
Reverse Transfer Capacitance	$C_{rss}$			175		
Total Gate Charge <sup>c</sup>	$Q_g$	$V_{DS} = -50\text{ V}, V_{GS} = -10\text{ V}, I_D = -10\text{ A}$		106	160	nC
		$V_{DS} = -50\text{ V}, V_{GS} = -4.5\text{ V}, I_D = -10\text{ A}$		54	81	
Gate-Source Charge <sup>c</sup>	$Q_{gs}$	$V_{DS} = -50\text{ V}, V_{GS} = -4.5\text{ V}, I_D = -10\text{ A}$		14		
Gate-Drain Charge <sup>c</sup>	$Q_{gd}$			26		
Gate Resistance	$R_g$	$f = 1.0\text{ MHz}$	0.8	4	8	$\Omega$
Turn-On Delay Time <sup>c</sup>	$t_{d(on)}$	$V_{DD} = -50\text{ V}, R_L = 6.3\text{ }\Omega$ $I_D \cong -8\text{ A}, V_{GEN} = -10\text{ V}, R_g = 1.0\text{ }\Omega$		15	25	ns
Rise Time <sup>c</sup>	$t_r$			20	30	
Turn-Off Delay Time <sup>c</sup>	$t_{d(off)}$			110	165	
Fall Time <sup>c</sup>	$t_f$			100	150	
Turn-On Delay Time <sup>c</sup>	$t_{d(on)}$	$V_{DD} = -50\text{ V}, R_L = 6.3\text{ }\Omega$ $I_D \cong 8\text{ A}, V_{GEN} = -4.5\text{ V}, R_g = 1.0\text{ }\Omega$		42	65	
Rise Time <sup>c</sup>	$t_r$			160	240	
Turn-Off Delay Time <sup>c</sup>	$t_{d(off)}$			100	150	
Fall Time <sup>c</sup>	$t_f$			100	150	
<b>Source-Drain Diode Ratings and Characteristics <math>T_C = 25\text{ }^\circ\text{C}</math><sup>b</sup></b>						
Continuous Current	$I_S$				-40	A
Pulsed Current	$I_{SM}$				-40	
Forward Voltage <sup>a</sup>	$V_{SD}$	$I_F = -10\text{ A}, V_{GS} = 0\text{ V}$		-0.8	-1.5	V
Reverse Recovery Time	$t_{rr}$	$I_F = -8\text{ A}, di/dt = 100\text{ A}/\mu\text{s}$		60	90	ns
Peak Reverse Recovery Current	$I_{RM(REC)}$			-5	-7.5	A
Reverse Recovery Charge	$Q_{rr}$				150	225

## Notes:

- Pulse test; pulse width  $\leq 300\text{ }\mu\text{s}$ , duty cycle  $\leq 2\%$ .
- Guaranteed by design, not subject to production testing.
- Independent of operating temperature.

Stresses beyond those listed under "Absolute Maximum Ratings" may cause permanent damage to the device. These are stress ratings only, and functional operation of the device at these or any other conditions beyond those indicated in the operational sections of the specifications is not implied. Exposure to absolute maximum rating conditions for extended periods may affect device reliability.



**TYPICAL CHARACTERISTICS** 25 °C, unless otherwise noted

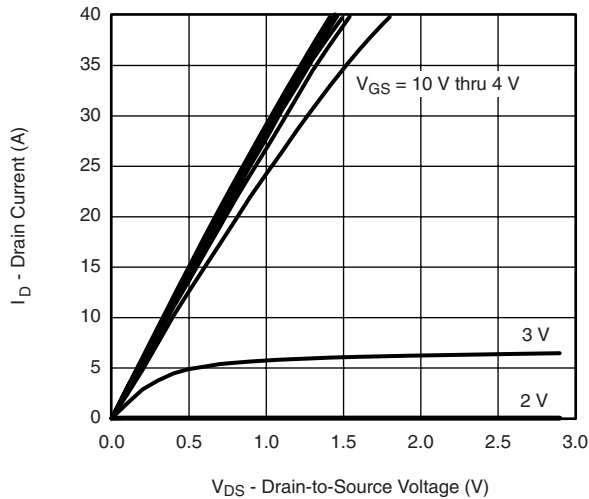

$V_{DS}$  - Drain-to-Source Voltage (V)

**Output Characteristics**

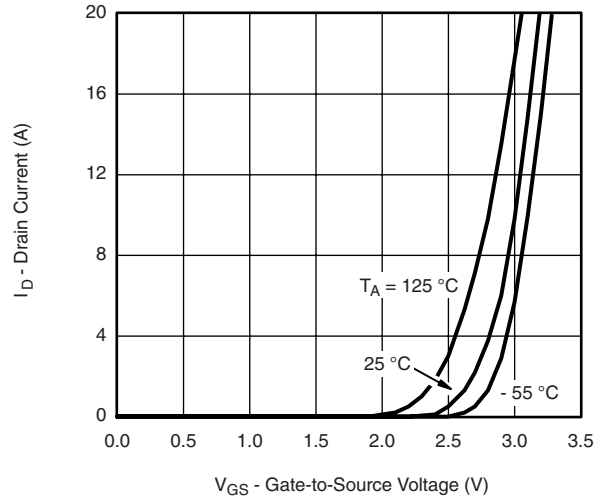

$V_{GS}$  - Gate-to-Source Voltage (V)

**Transfer Characteristics**

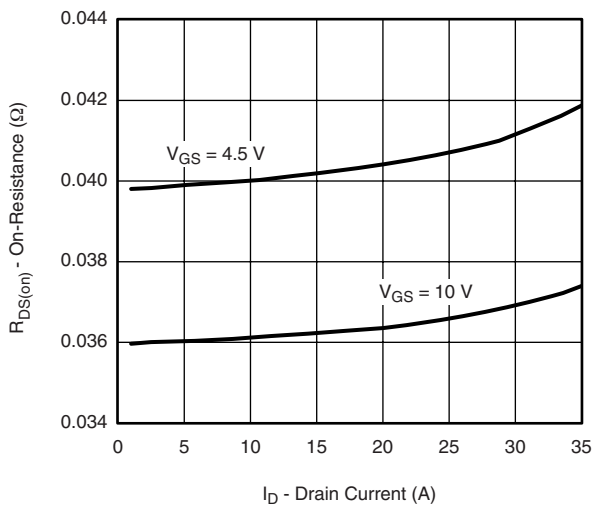

**On-Resistance vs. Drain Current and Gate Voltage**

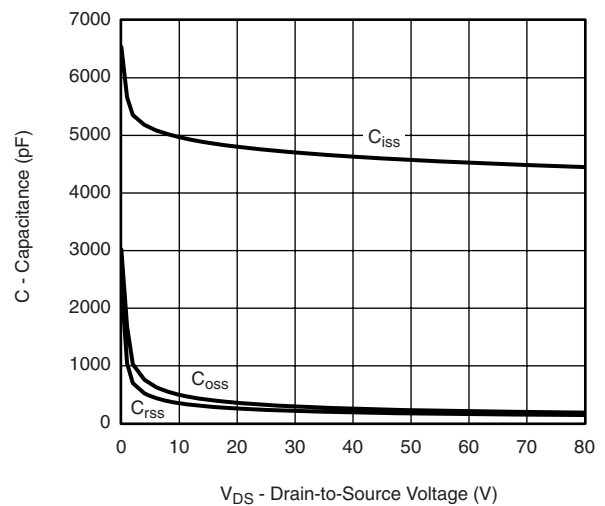

**Capacitance**

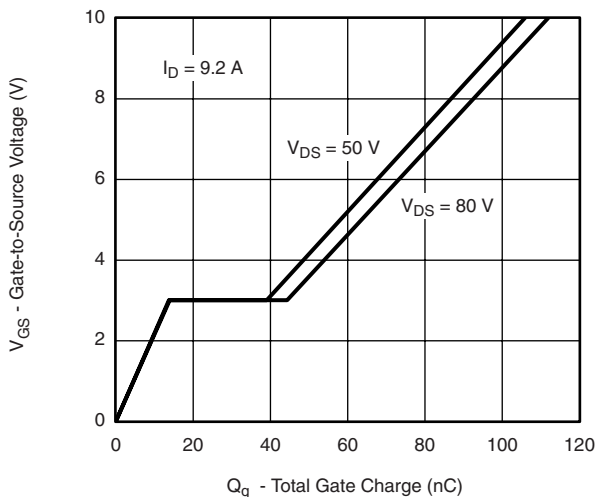

**Gate Charge**

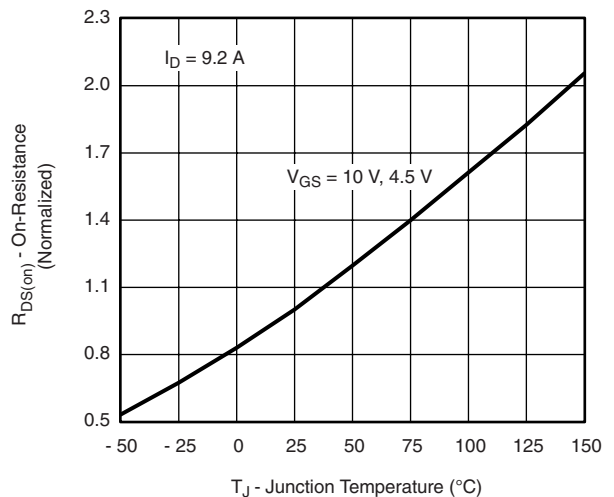

**On-Resistance vs. Junction Temperature**

# SUP40P10-43



Vishay Siliconix

## TYPICAL CHARACTERISTICS 25 °C, unless otherwise noted

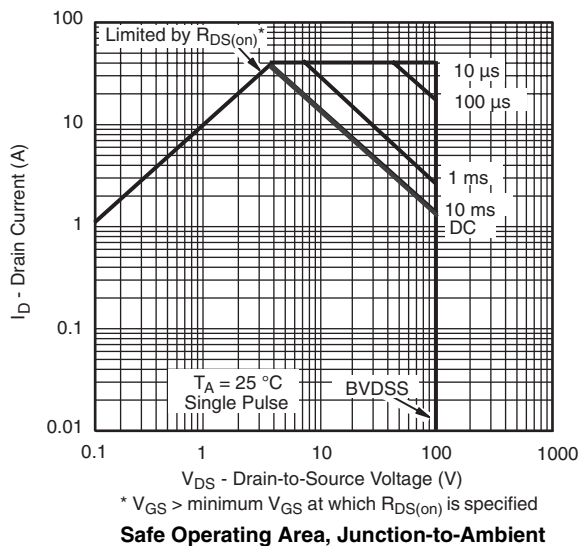
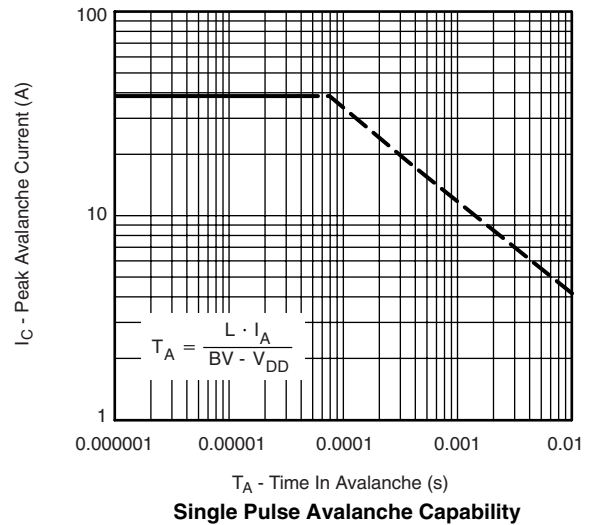
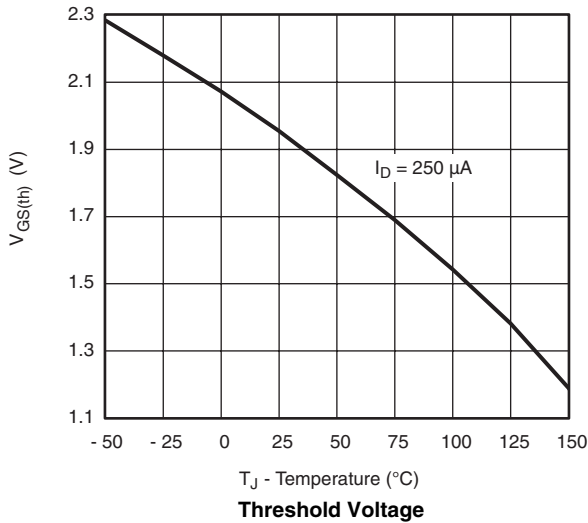
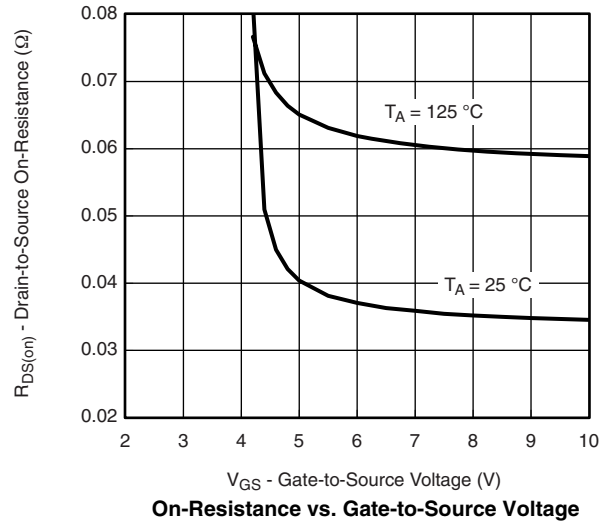
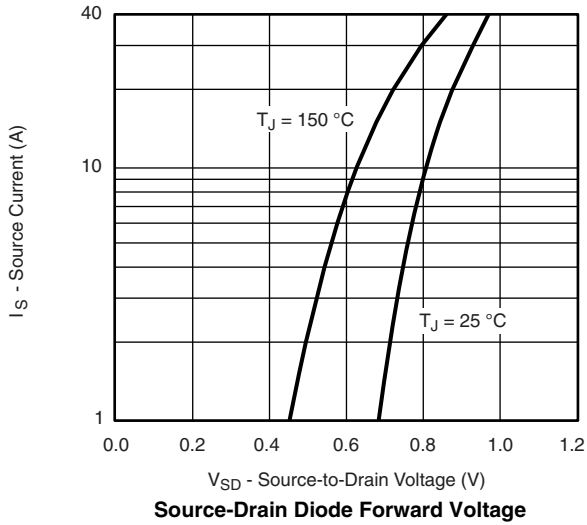



**TYPICAL CHARACTERISTICS** 25 °C, unless otherwise noted

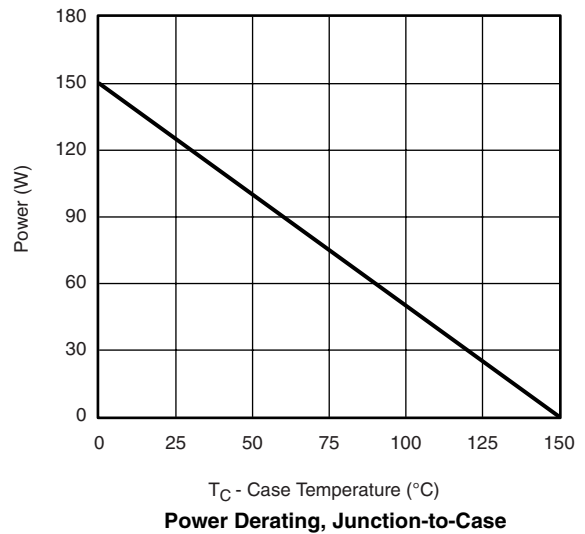
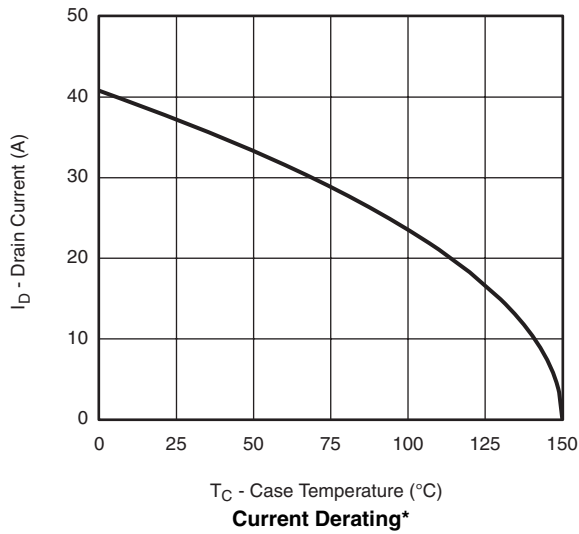

\* The power dissipation  $P_D$  is based on  $T_{J(max)} = 150$  °C, using junction-to-case thermal resistance, and is more useful in settling the upper dissipation limit for cases where additional heatsinking is used. It is used to determine the current rating, when this rating falls below the package limit.

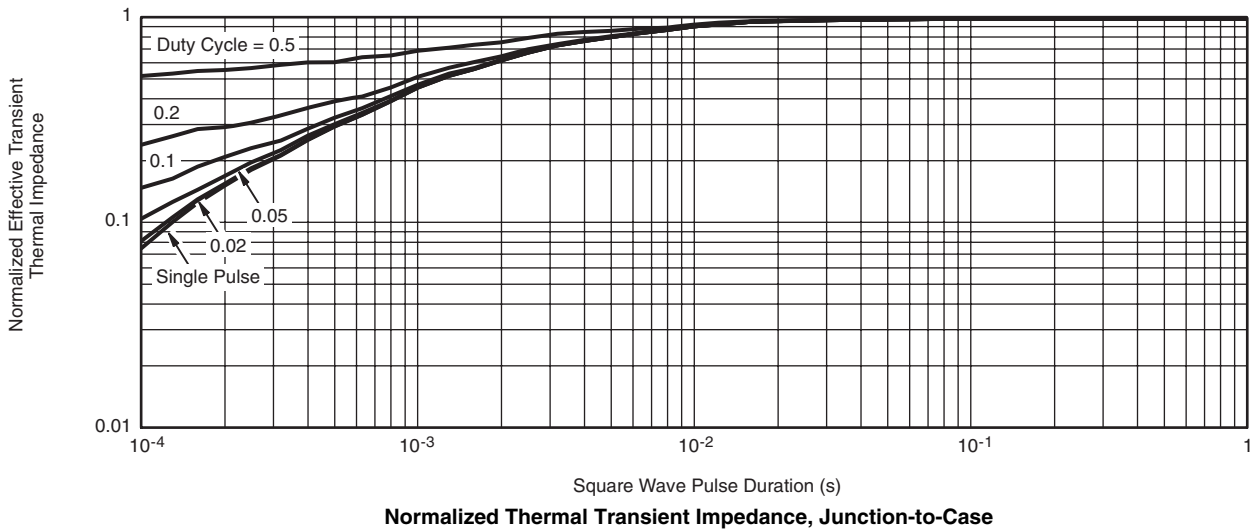

Vishay Siliconix maintains worldwide manufacturing capability. Products may be manufactured at one of several qualified locations. Reliability data for Silicon Technology and Package Reliability represent a composite of all qualified locations. For related documents such as package/tape drawings, part marking, and reliability data, see [www.vishay.com/ppg?65458](http://www.vishay.com/ppg?65458).

## TO-220AB

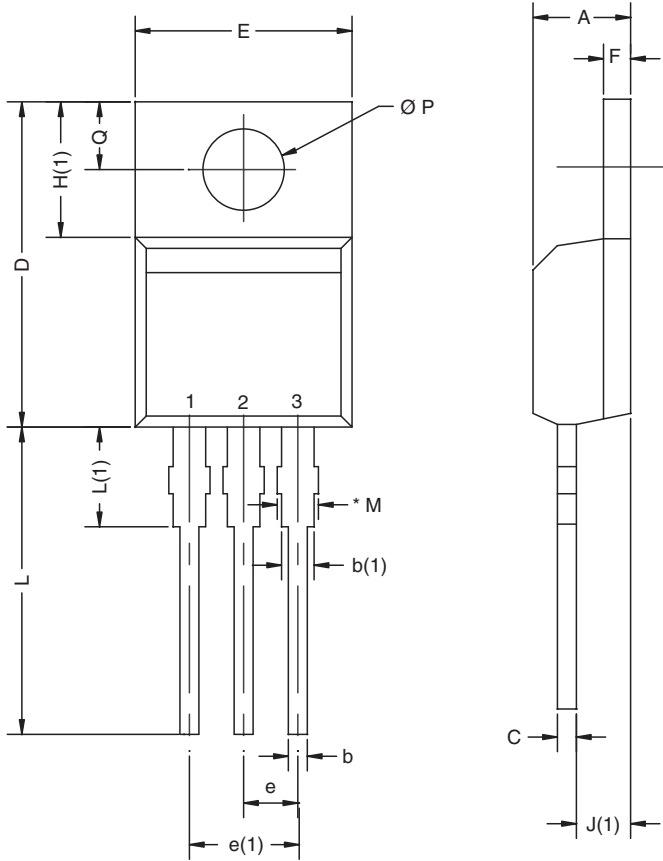

DIM.	MILLIMETERS		INCHES	
	MIN.	MAX.	MIN.	MAX.
A	4.25	4.65	0.167	0.183
b	0.69	1.01	0.027	0.040
b(1)	1.20	1.73	0.047	0.068
c	0.36	0.61	0.014	0.024
D	14.85	15.49	0.585	0.610
E	10.04	10.51	0.395	0.414
e	2.41	2.67	0.095	0.105
e(1)	4.88	5.28	0.192	0.208
F	1.14	1.40	0.045	0.055
H(1)	6.09	6.48	0.240	0.255
J(1)	2.41	2.92	0.095	0.115
L	13.35	14.02	0.526	0.552
L(1)	3.32	3.82	0.131	0.150
Ø P	3.54	3.94	0.139	0.155
Q	2.60	3.00	0.102	0.118

ECN: X10-0416-Rev. M, 01-Nov-10  
DWG: 5471

**Note**

\* M = 1.32 mm to 1.62 mm (dimension including protrusion)  
Heatsink hole for HVM



## Disclaimer

ALL PRODUCT, PRODUCT SPECIFICATIONS AND DATA ARE SUBJECT TO CHANGE WITHOUT NOTICE TO IMPROVE RELIABILITY, FUNCTION OR DESIGN OR OTHERWISE.

Vishay Intertechnology, Inc., its affiliates, agents, and employees, and all persons acting on its or their behalf (collectively, "Vishay"), disclaim any and all liability for any errors, inaccuracies or incompleteness contained in any datasheet or in any other disclosure relating to any product.

Vishay makes no warranty, representation or guarantee regarding the suitability of the products for any particular purpose or the continuing production of any product. To the maximum extent permitted by applicable law, Vishay disclaims (i) any and all liability arising out of the application or use of any product, (ii) any and all liability, including without limitation special, consequential or incidental damages, and (iii) any and all implied warranties, including warranties of fitness for particular purpose, non-infringement and merchantability.

Statements regarding the suitability of products for certain types of applications are based on Vishay's knowledge of typical requirements that are often placed on Vishay products in generic applications. Such statements are not binding statements about the suitability of products for a particular application. It is the customer's responsibility to validate that a particular product with the properties described in the product specification is suitable for use in a particular application. Parameters provided in datasheets and/or specifications may vary in different applications and performance may vary over time. All operating parameters, including typical parameters, must be validated for each customer application by the customer's technical experts. Product specifications do not expand or otherwise modify Vishay's terms and conditions of purchase, including but not limited to the warranty expressed therein.

Except as expressly indicated in writing, Vishay products are not designed for use in medical, life-saving, or life-sustaining applications or for any other application in which the failure of the Vishay product could result in personal injury or death. Customers using or selling Vishay products not expressly indicated for use in such applications do so at their own risk and agree to fully indemnify and hold Vishay and its distributors harmless from and against any and all claims, liabilities, expenses and damages arising or resulting in connection with such use or sale, including attorneys fees, even if such claim alleges that Vishay or its distributor was negligent regarding the design or manufacture of the part. Please contact authorized Vishay personnel to obtain written terms and conditions regarding products designed for such applications.

No license, express or implied, by estoppel or otherwise, to any intellectual property rights is granted by this document or by any conduct of Vishay. Product names and markings noted herein may be trademarks of their respective owners.