

PAL16RP8A Series

16P8A, 16RP8A 16RP6A, 16RP4A

Features/Benefits

- Programmable polarity
- High speed at 25 ns tPD
- Register preload
- Power-up reset
- Security fuse

Description

The PAL16RP8A Series is equivalent to the PAL16R8A Series, with the addition of programmable polarity. With programmable polarity unused, these devices are equivalent to the PAL16R8A Series.

Variable Input/Output Pin Ratio

The registered devices have eight dedicated input lines, and each combinatorial output is an I/O pin. The combinatorial device has ten dedicated input lines, and only six of the eight combinatorial outputs are I/O pins. Buffers for device inputs have complementary outputs to provide user-programmable input signal polarity. Unused input pins should be tied directly to VCC or GND.

Programmable Three-State Outputs

Each output has a three-state output buffer with programmable three-state control. On combinatorial outputs, a product term controls the buffer, allowing enable and disable to be a function of any combination of device inputs or output feedback. The output provides a bidirectional I/O pin in the combinatorial configuration, and may be configured as a dedicated input if the buffer is always disabled.

Registers with Feedback

Registered outputs are provided for data storage and synchronization. Registers are composed of D-type flip-flops which are loaded on the low-to-high transition of the clock input.

PAL16RP8A Series

	ARRAY INPUTS	OUTPUTS		t _{PD} * (ns)	I _{CC} (mA)
		COMBINATORIAL	REGISTERED		
PAL16P8A	16	8	0	25/30	180
PAL16RP8A	16	0	8	25/30	180
PAL16RP6A	16	6	2	25/30	180
PAL16RP4A	16	4	4	25/30	180

*25 ns active low, 30 ns active high

Ordering Information

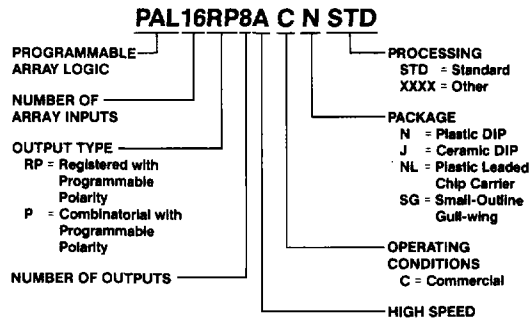

Polarity

Each of these devices offers programmable polarity on each output. If the polarity fuse is unused, the output is active low. If the polarity fuse is programmed, the output is inverted to active high.

Preload and Power-Up Reset

Each device also offers register preload for device testability. The registers can be preloaded from the outputs by using supervoltages in order to simplify functional testing. This series also offers Power-Up Reset, whereby the registers power up to a logic LOW, setting the active-low outputs to a logic HIGH.

Performance

Performance varies according to the use of the programmable polarity. Active low outputs have a tPD of 25 ns, while active high outputs have a tPD of 30 ns due to the extra inversion. All devices consume 180 mA maximum ICC.

Packages

The commercial PAL16RP8A Series is available in the plastic DIP (N), ceramic DIP (J), plastic leaded chip carrier (NL), and small outline (SG) packages.

5

PAL16RP8A Series
16P8A, 16RP8A, 16RP6A, 16RP4A

DIP/SO Pinouts

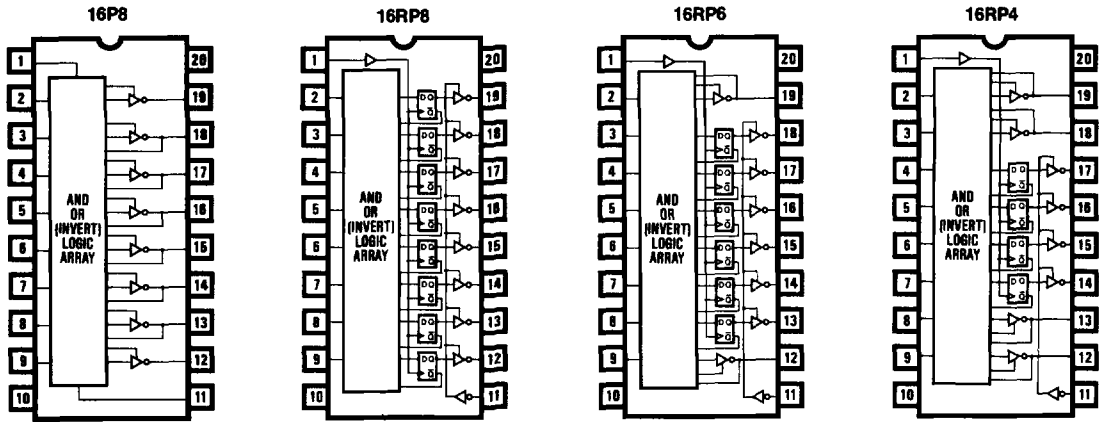

PLCC Pinouts

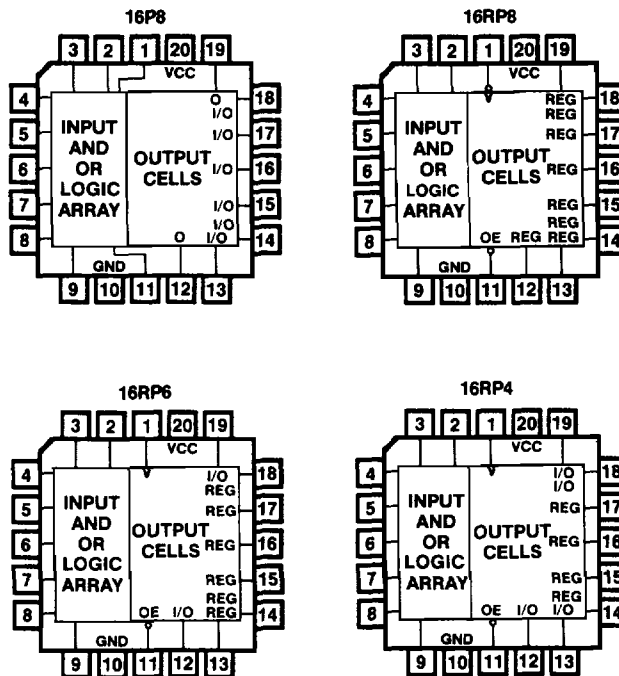

Package Drawings

(refer to PAL Device Package Outlines, page 3-179)

PAL16RP8A Series
16P8A, 16RP8A, 16RP6A, 16RP4A

Absolute Maximum Ratings

	Operating	Programming
Supply voltage V_{CC}	-0.5 V to 7.0 V	-0.5 V to 12.0 V
Input voltage	-1.5 V to 5.5 V	-1.0 V to 22.0 V
Off-state output voltage	5.5 V	12.0 V
Storage temperature		-65°C to +150°C

Operating Conditions

SYMBOL	PARAMETER		COMMERCIAL ¹			UNIT	
			MIN	TYP	MAX		
V_{CC}	Supply voltage		4.75	5	5.25	V	
t_w	Width of clock	Low	20	14		ns	
		High	10	6			
t_{su}	Set up time from input or feedback to clock	16RP8A 16RP6A 16RP4A	Polarity fuse intact		25	15	ns
			Polarity fuse programmed		30	20	
t_h	Hold time		0	-10		ns	
T_A	Operating free-air temperature		0		75	°C	

Electrical Characteristics Over Operating Conditions

SYMBOL	PARAMETER	TEST CONDITIONS		MIN	TYP	MAX	UNIT
V_{IL}^2	Low-level input voltage					0.8	V
V_{IH}^2	High-level input voltage			2			V
V_{IC}	Input clamp voltage	$V_{CC} = \text{MIN}$	$I_I = -18 \text{ mA}$	-0.8	-1.5		V
I_{IL}^3	Low-level input current	$V_{CC} = \text{MAX}$	$V_I = 0.4 \text{ V}$	-0.02	-0.25		mA
I_{IH}^3	High-level input current	$V_{CC} = \text{MAX}$	$V_I = 2.4 \text{ V}$		25		μA
I_I	Maximum input current	$V_{CC} = \text{MAX}$	$V_I = 5.5 \text{ V}$		100		μA
V_{OL}	Low-level output voltage	$V_{CC} = \text{MIN}$	$I_{OL} = 24 \text{ mA}$	0.3	0.5		V
V_{OH}	High-level output voltage	$V_{CC} = \text{MIN}$	$I_{OH} = -3.2 \text{ mA}$	2.4	2.8		V
I_{OZL}^3	Off-state output current	$V_{CC} = \text{MAX}$	$V_O = 0.4 \text{ V}$		-100		μA
I_{OZH}^3			$V_O = 2.4 \text{ V}$		100		μA
I_{OS}^4	Output short-circuit current	$V_{CC} = 5 \text{ V}$	$V_O = 0 \text{ V}$	-30	-70	-130	mA
I_{CC}	Supply current	$V_{CC} = \text{MAX}$		120	180		mA

- The PAL16RP8A Series is designed to operate over the full military operating conditions. For availability and specifications, contact Monolithic Memories.
- These are absolute voltages with respect to the ground pin on the device and include all overshoots due to system and/or tester noise. Do not attempt to test these values without suitable equipment.
- I/O pin leakage is the worst case of I_{IL} and I_{OZL} (or I_{IH} and I_{OZH}).
- No more than one output should be shorted at a time, and duration of the short circuit should not exceed one second.

5

PAL16RP8A Series
16P8A, 16RP8A, 16RP6A, 16RP4A

Switching Characteristics Over Operating Conditions

SYMBOL	PARAMETER		TEST CONDITIONS	MIN TYP MAX			UNIT
				MIN	TYP	MAX	
t _{PD}	Input or feedback to output 16P8A, 16RP6A, 16RP4A	Polarity fuse intact	R ₁ = 200 Ω R ₂ = 390 KΩ	15	25	ns	
		Polarity fuse programmed		20	30		
t _{CLK}	Clock to output	10		15	ns		
t _{CF}	Clock to feedback	8		10	ns		
t _{PZX}	Pin 11 to output enable except 16P8A	10		20	ns		
t _{pxZ}	Pin 11 to output disable except 16P8A	11		20	ns		
t _{EA}	Input to output enable	16P8A, 16RP6A, 16RP4A		10	25	ns	
t _{ER}	Input to output disable	16P8A, 16RP6A, 16RP4A		13	25	ns	
f _{MAX}	Maximum frequency 16RP8A, 16RP6A, 16RP4A	External		Polarity fuse intact	25	40	MHz
				Polarity fuse programmed	22	33	
		Internal	Polarity fuse intact	28.5	43		
			Polarity fuse programmed	25	35		
		No feedback	33	50			

Switching Test Load

(refer to page 5-164)

Power-Up Reset Waveform

(refer to page 5-164)

Programmers/Development Systems

(refer to Programmer Reference Guide, page 3-81)

Schematic of Inputs and Outputs

(refer to page 5-164)

Register Preload Waveform

(refer to page 5-164)

Switching Waveforms

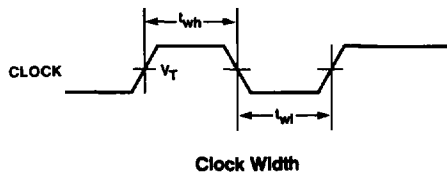
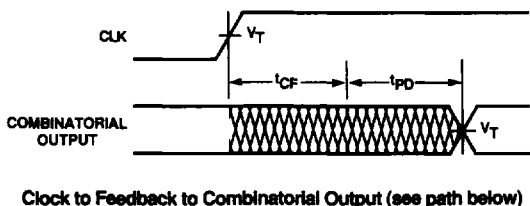
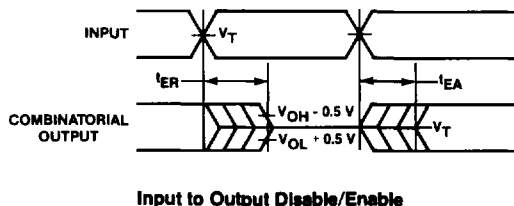
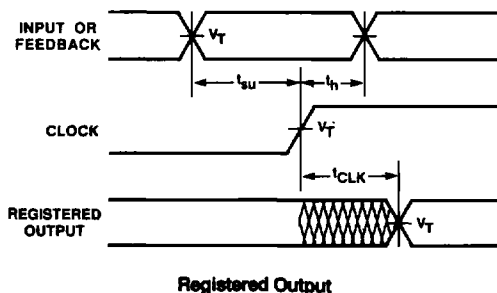
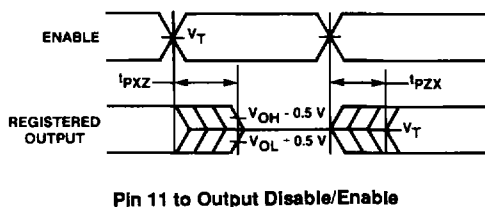
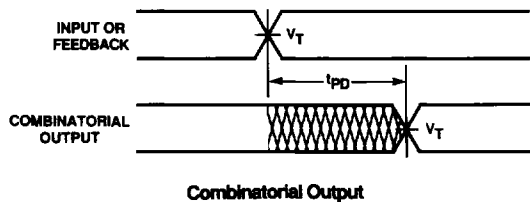

5

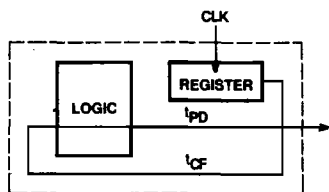

- Notes:
1. $V_T = 1.5V$
 2. Input pulse amplitude 0 V to 3.0 V
 3. Input rise and fall times 2-5 ns typical

Key to Timing Diagrams

WAVEFORM	INPUTS	OUTPUTS
	DON'T CARE; CHANGE PERMITTED	CHANGING; STATE UNKNOWN
	NOT APPLICABLE	CENTER LINE IS HIGH IMPEDANCE STATE
	MUST BE STEADY	WILL BE STEADY

PAL16RP8A Series
16P8A, 16RP8A, 16RP6A, 16RP4A

Logic Diagram

16P8A

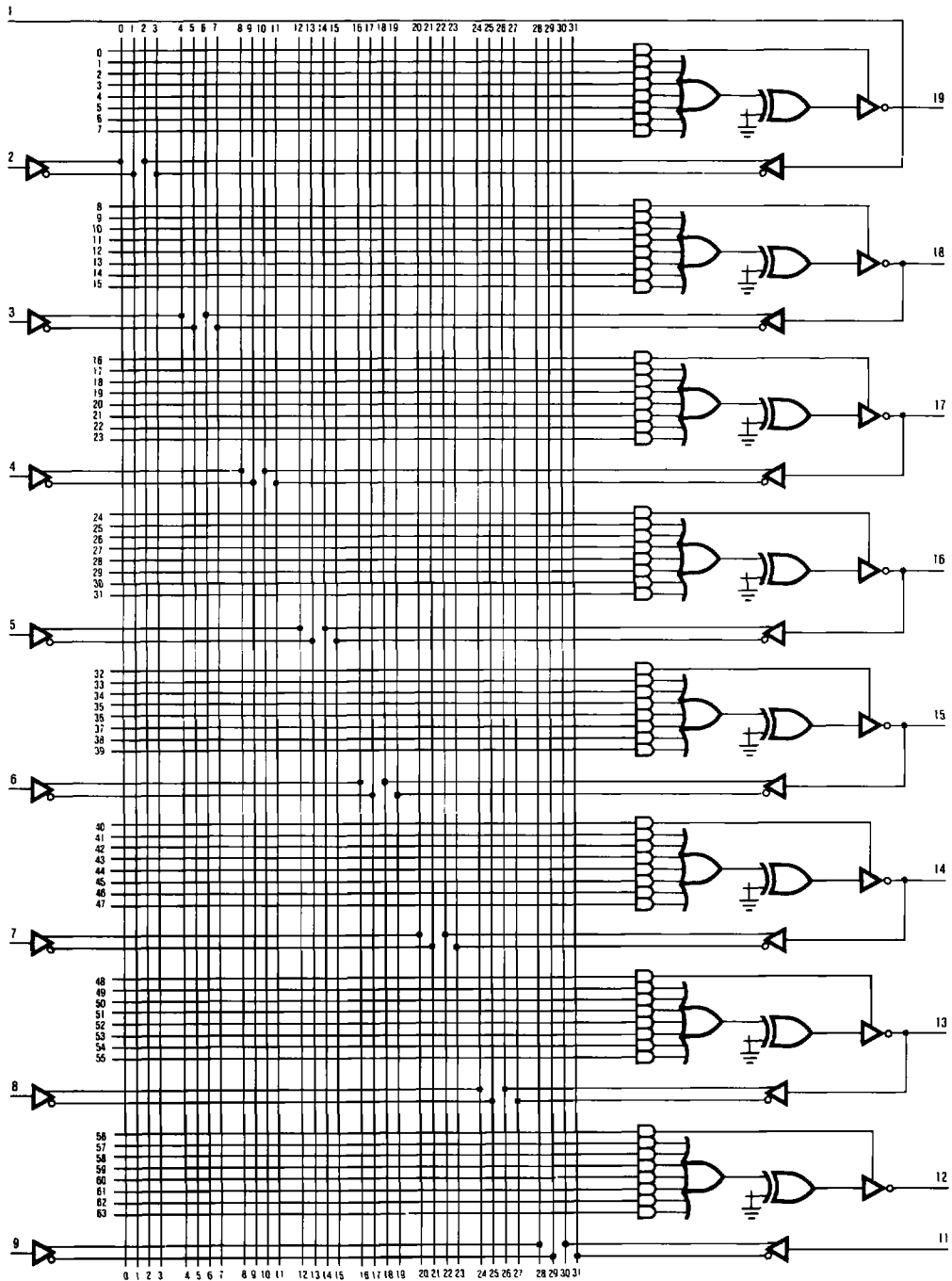

PAL16RP8A Series
16P8A, 16RP8A, 16RP6A, 16RP4A

Logic Diagram

16RP8A

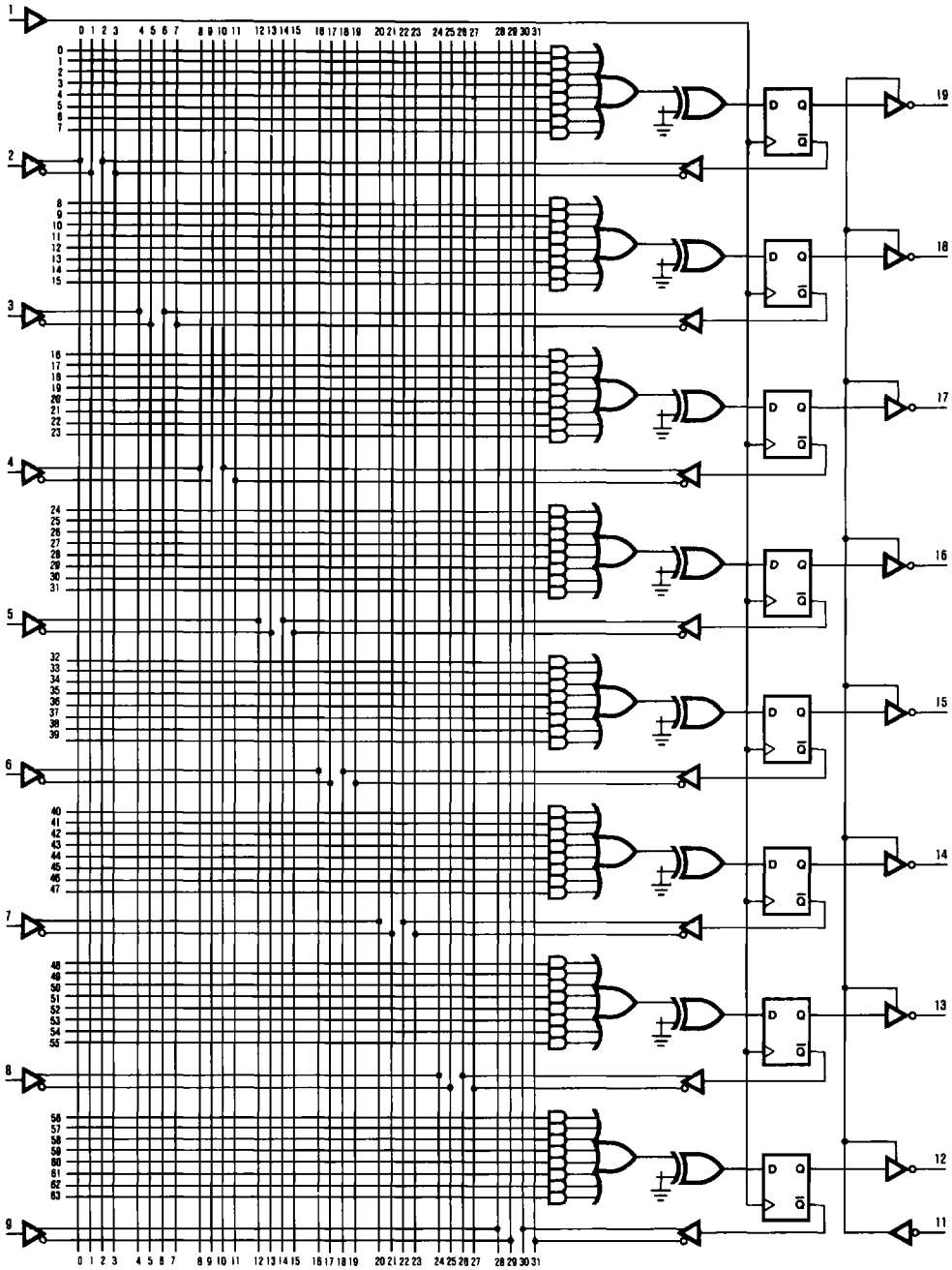

5

PAL16RP8A Series
16P8A, 16RP8A, 16RP6A, 16RP4A

Logic Diagram

16RP6A

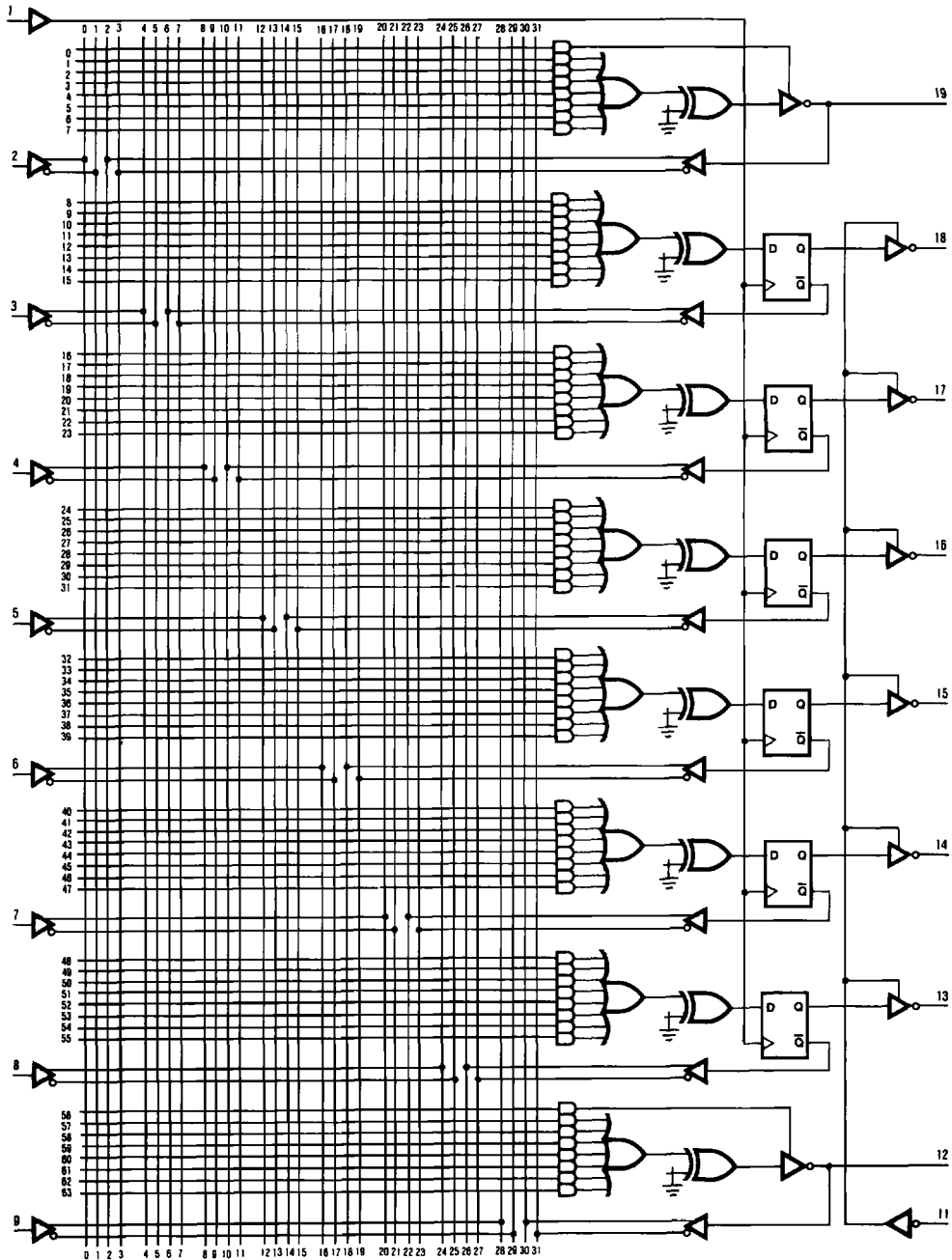

PAL16RP8A Series
16P8A, 16RP8A, 16RP6A, 16RP4A

Logic Diagram

16RP4A

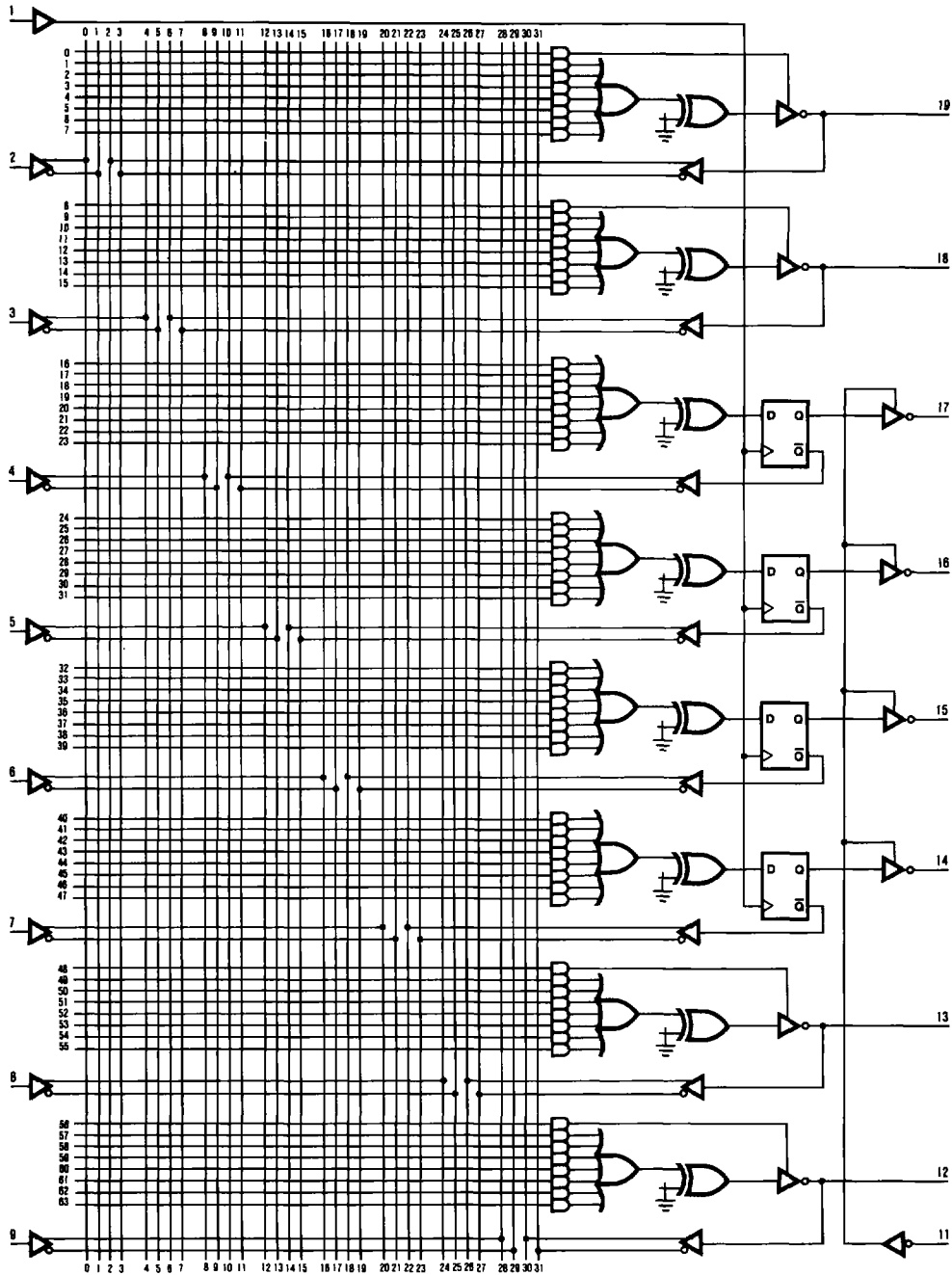

5