

## Adjustable Carbon Attenuators

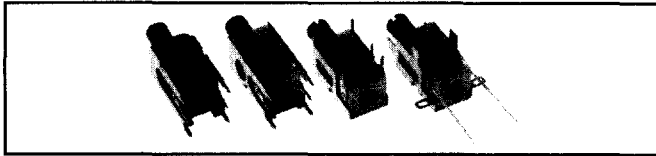

### FEATURES

- Model M2001H is for matching the characteristic impedance of coaxial antenna cables and is suitable for antenna amplifiers of up to 900MHz.

### MECHANICAL SPECIFICATIONS

**Casing:** Plastic material, dust protected.  
**Shielded Basket/PINS:** Electroplated SN, 5 $\mu$ .  
**Mounting:** Fish-plates.  
**Adjustment:** Insulated plastic shaft with screwdriver slot and .079 inch [2mm] hexagon.  
**Terminals:** Silver plated lugs, tinned pins.  
**Nominal angle of rotation:** 3 (+ 3.0 - 0.5) revolutions.  
 6 revolutions on request.  
**Operating torque:** .56 to 1.96 oz. in.  
**End stop torque:** 4.97 oz. in. (7 Ncm). Fixed stop at 3 revolutions. 6 revolutions, clutch mechanism, no end stop.  
**Weight:** .13 to .14 oz.

### MATERIAL SPECIFICATIONS

**Cover:** Makrolon 94V2.  
**Shaft:** Durethan 94V0.  
**Case:** Hostaform 94HB.

### STANDARD ELECTRICAL SPECIFICATIONS

Resistive Element	Carbon on laminated paper
Wiper Contact	Metal
Impedance	75 ohms, 50 ohms (60 ohms on request)
Power Rating	.25 watt
Nominal Attenuation and Tolerance	20dB (+ 5 - 2dB), 10dB (+ 2 - 2dB), 6dB on request
Adjustable Minimum Attenuation	$\leq 0.5\text{dB}$
Variation in Attenuation Due to Frequency	
up to 300MHz	$\leq 0.25\text{dB}$
over 300 to 900MHz	$\leq 1\text{dB}$
Reflexion Attenuation	.5 to 20dB attenuation
up to 300MHz	$\geq 20\text{dB}$
up to 900MHz	$\geq 15\text{dB}$
Temperature Limits	- 25°C to + 70°C

**NOTE:** Typical curves for transmission and return loss available.

### DIMENSIONAL CONFIGURATIONS [Numbers in brackets indicate millimeters]

M2001HP1

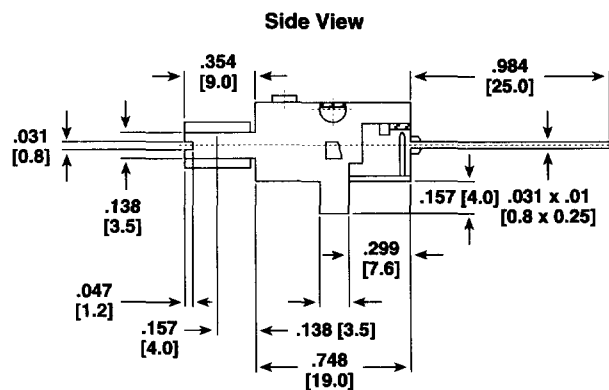

End View (All Versions)

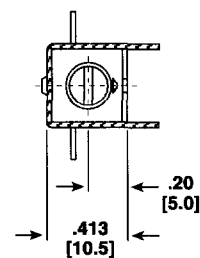

Top View

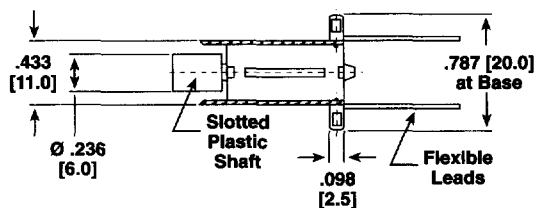

Electrical Circuit

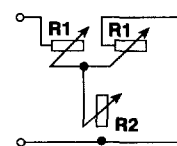

## DIMENSIONAL CONFIGURATIONS [Numbers in brackets indicate millimeters]

### M2001HP2

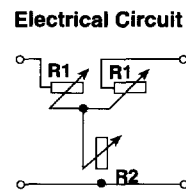
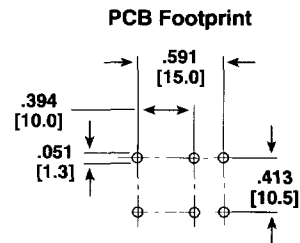
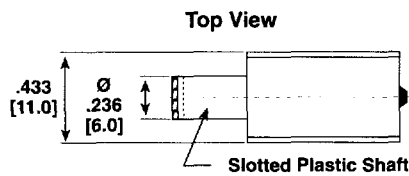
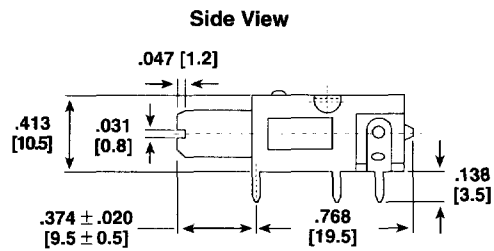

### M2001HS2

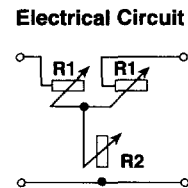
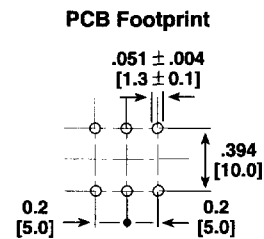
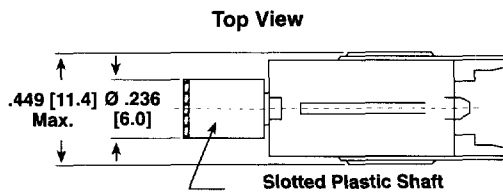
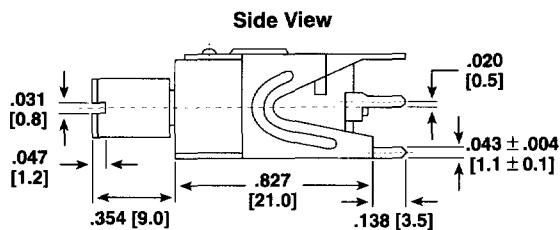

### M2001HP3

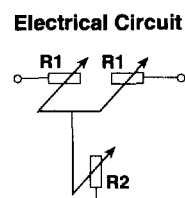
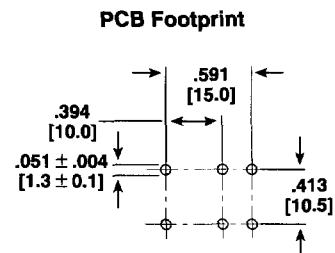
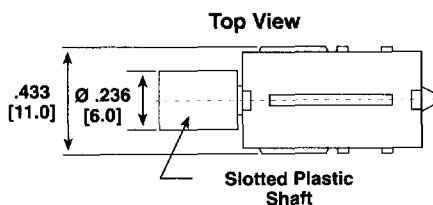
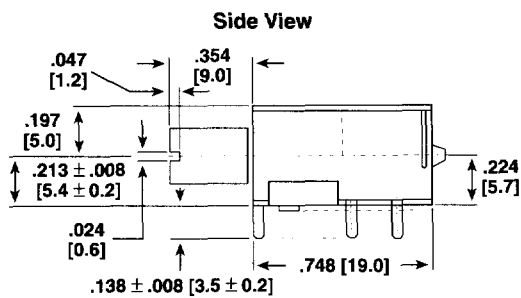

# Model M2001H

Vishay Sfernice



## PACKAGING

**M2001HP1, M2001HS2:** 250 pieces in bulk.  
**M2001HP2, M2001HP3:** 100 pieces in plastic insert.

## HOW TO ORDER

