

REFERENCE SPECIFICATIONS

-NFC 93425 (in compliance with HE 507)

PHYSICAL CHARACTERISTICS

- INSULATOR MATERIAL: THERMOPLASTIC UL94V0
- CONTACT MATERIAL: BRASS  
GOLD OVER NICKEL
- ACCESSORIES: STAINLESS STEEL or BRASS  
Cadmium plated, yellow passivation
- SHELLS: STEEL  
Cadmium plated, yellow passivation

ELECTRICAL CHARACTERISTICS

- NOMINAL CURRENT: 7.5A (SIGNAL CONTACT)
- CONTACT RESISTANCE: <=7.3 m Ohms SIGNAL
- CONTACT/CONTACT : >=1000 V
- CONTACT/GROUND : >=1200 V
- INSULATION RESISTANCE: >=5000 MOhms
- CLIMATIC CATEGORY: 55/125/21  
TEMPERATURE RANGE -55°C TO +125°C  
DAMP HEAT STEADY STATE 56 DAYS  
SALT SPRAY 48 HOURS

# DBML13W3P300N

Series ←

Shell size: **E A B C D** ←  
see sheet 3

**M** :characteristic  
for the DM series

Front accessory definition  
see sheet 2

**Blank** :without accessory

**L** :threaded insert M3

**O** :threaded insert UNC 4-40

**V** :female screw UNC 4-40

**F** :floating mounting

**S** :spacer

Layout of contacts (see sheet 3) ←

Contacts ←

**P** :Pin

Termination type ←

**3** Straight version

Plating ←

**00** straight solder 500 matings/unmatings

**43** straight solder 500 matings/unmatings for harsh environment

**N** :obligatory indication for HE 507 series ←

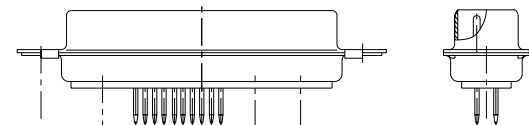

I3W3 FOR EXAMPLE

www.fciconnect.com				surface	ISO 1302	tolerance std	ISO 406	ISO 1101	projection	mm	
				TOLERANCES UNLESS OTHERWISE SPECIFIED							
Dr	M PESSON	2006/11/15	ANGULAR	0.X	±0.3	size	A2	Scale	2:1		
Eng	P LEGARE	2006/11/15	LINEAR	0.xx	±0.1	ECN	LS07-0273				
Chr	P LEGARE	2006/11/15	0° ±2°	0.xxx	±0.05						
Appr	P LEGARE	2006/11/15	Product family	- Spec ref							
FCI				SUB MALE DMW				cat no	C01-8637-1752		Rev.
				mixed power straight solder							B
				catalog no				CUSTOMER		sheet 1 of 7	

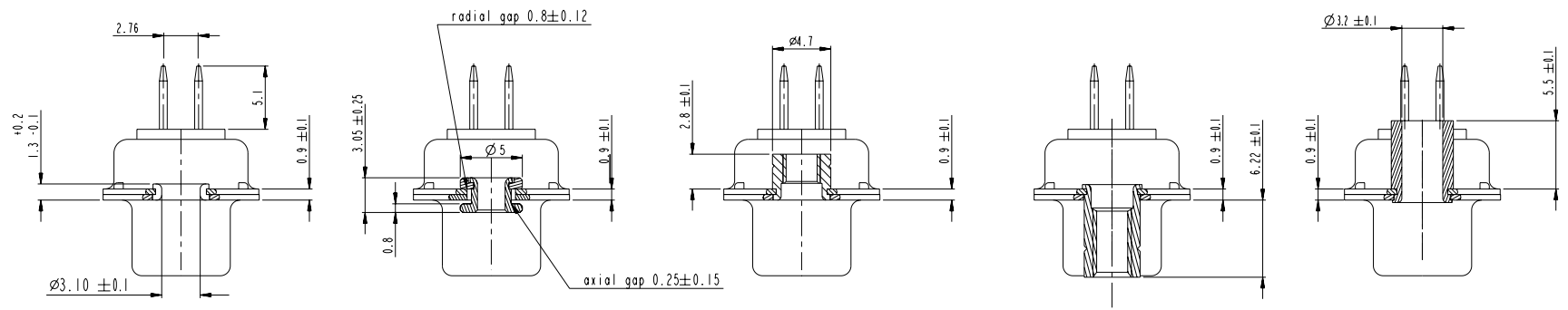

FRONT ACCESSORY    **Blank** without    **F** floating mounting    **L** insert M3    **O** insert UNC 4.40    **V** femelle screw UNC 4.40    **S** Spacer

shell size LAYOUTS

PART NUMBER	FRONT ACCESSORY
D*MxWxP300N	without
D*MFxWxP300N	floating mounting
D*MLxWxP300N	insert M3
D*MOxWxP300N	insert UNC 4.40
D*MVxWxP300N	female screw UNC 4.40
D*MSxWxP300N	Spacer
D*MxWxP343N	without
D*MFxWxP343N	floating mounting
D*MLxWxP343N	insert M3
D*MOxWxP343N	insert UNC 4.40
D*MVxWxP343N	female screw UNC 4.40
D*MSxWxP343N	Spacer

- # xWx
- E 5W1
- A 11W1
- A 7W2
- B 21W1
- B 17W2
- B 13W3
- B 9W4
- C 25W3
- C 21WA4
- C 27W2
- D 47W1
- D 24W7
- D 36W4

Copyright FCJ

www.fciconnect.com		surface ISO 1302	tolerance std ISO 406 ISO 1101	projection mm
		TOLERANCES UNLESS OTHERWISE SPECIFIED		
Dr	M PESSON	2006/11/15	ANGULAR	0.X ±0.3
Eng	P LEGARE	2006/11/15	LINEAR	0.XX ±0.1
Chr	P LEGARE	2006/11/15	0° ±2°	0.XXX ±0.05
Appr	P LEGARE	2006/11/15	Product family	- Spec ref
FCJ		SUB MALE DMW		Rev. B
		mixed power straight solder		ang no C01-8637-1752
		catalog no		CUSTOMER sheet 2 of 7

SCALE: 4

5W1

LAYOUT AND CONNECTOR DIMENSIONS

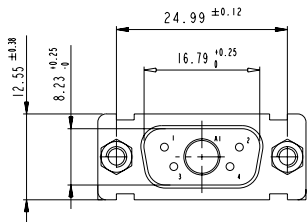
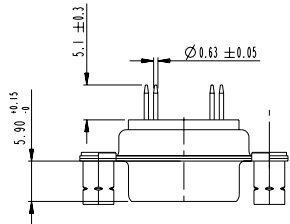
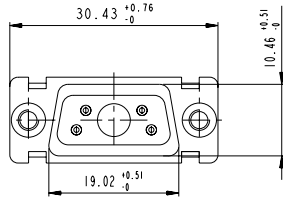
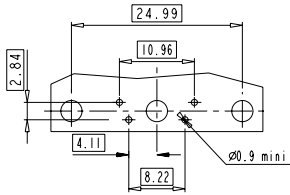

Floating signal contacts

11W1

LAYOUT AND CONNECTOR DIMENSIONS

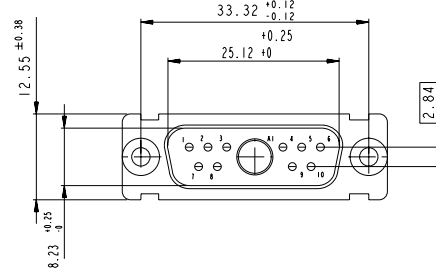
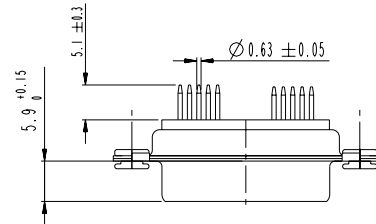
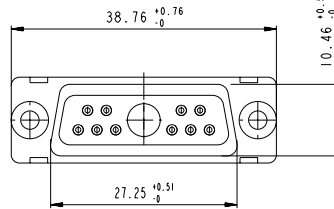
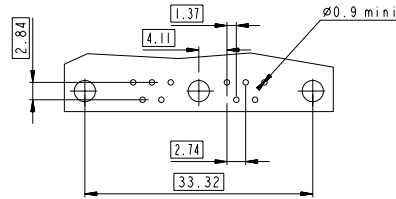

7W2

LAYOUT AND CONNECTOR DIMENSIONS

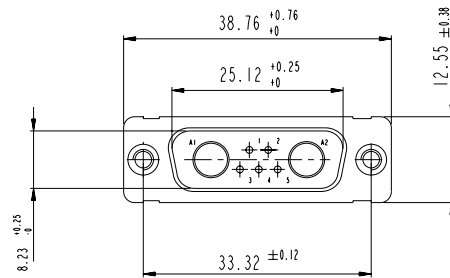
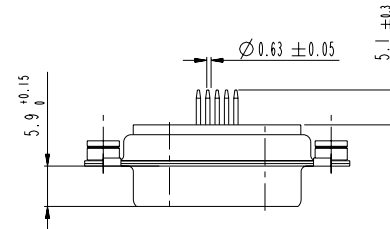
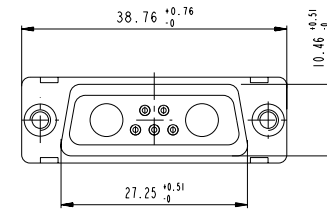
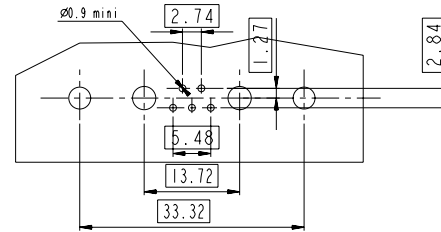

SIDE VIEW FOR LAYOUTS: E A B C

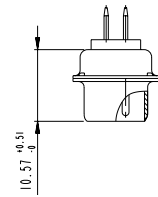

Copyright FCI.

www.fciconnect.com		surface ISO 1302	tolerance std ISO 406 ISO 1101	projection mm
		TOLERANCES UNLESS OTHERWISE SPECIFIED		
Dr M PESSON	2006/11/15	ANGULAR	0.X ±0.3	size A2 Scale 2:1
Eng P LEGARE	2006/11/15	LINEAR	0.XX ±0.1	ECN LS07-0273
Chr P LEGARE	2006/11/15	0° ±2°	0.XXX ±0.05	Spec ref
Appr P LEGARE	2006/11/15	Product family		
SUB MALE DMW mixed power straight solder catalog no		title SUB MALE DMW mixed power straight solder catalog no	drawing no C01-8637-1752	revision B
CUSTOMER			sheet 3 of 7	

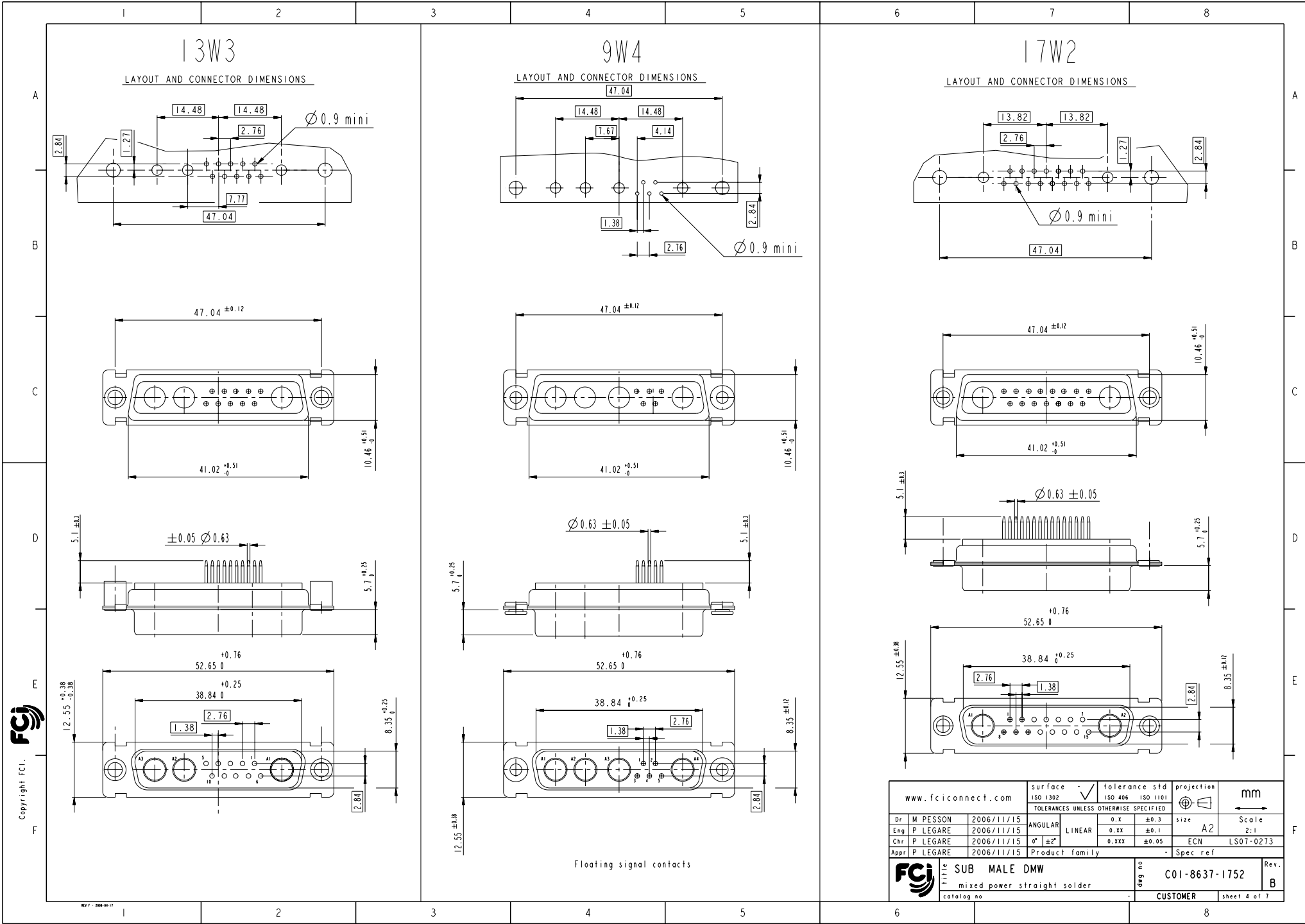

13W3

LAYOUT AND CONNECTOR DIMENSIONS

9W4

LAYOUT AND CONNECTOR DIMENSIONS

17W2

LAYOUT AND CONNECTOR DIMENSIONS

Copyright FCi



www.fciconnect.com		surface ISO 1302	tolerance std ISO 406 ISO 1101	projection TOLERANCES UNLESS OTHERWISE SPECIFIED	mm
Dr M PESSON	2006/11/15	ANGULAR	0.X ±0.3	size A2	Scale 2:1
Eng P LEGARE	2006/11/15	LINEAR	0.XX ±0.1	ECN	LS07-0273
Chr P LEGARE	2006/11/15	0° ±2°	0.XXX ±0.05	Product family	Spec ref
Appr P LEGARE	2006/11/15	Product family		- Spec ref	
		SUB MALE DMW		ang no C01-8637-1752	Rev. B
mixed power straight solder		catalog no		CUSTOMER	sheet 4 of 7

Floating signal contacts

# 21W1

## LAYOUT AND CONNECTOR DIMENSIONS

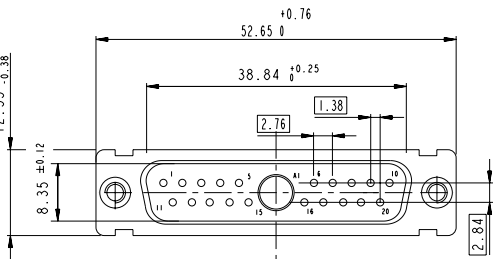
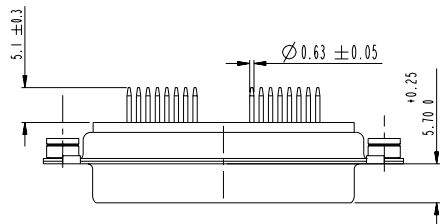
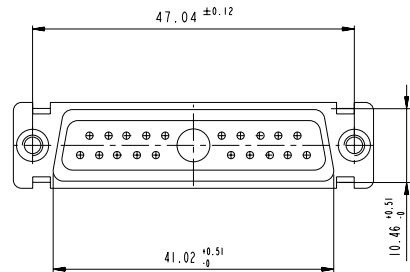
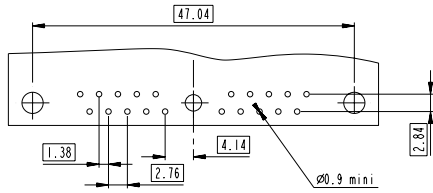

Floating signal contacts

# 27W2

## LAYOUT AND CONNECTOR DIMENSIONS

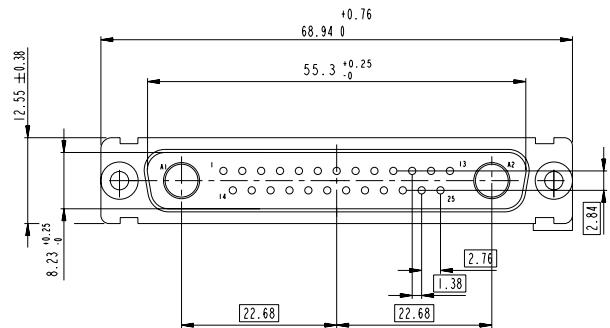
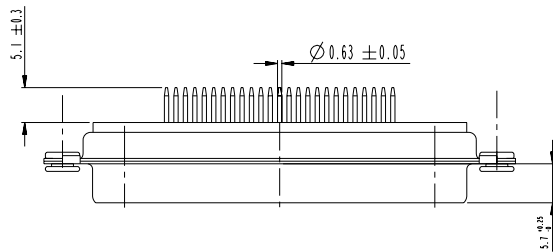
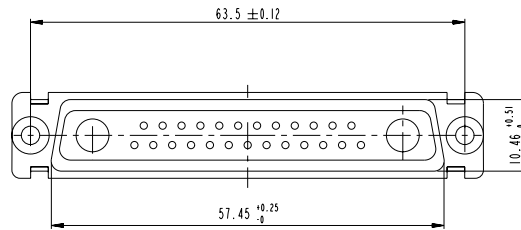
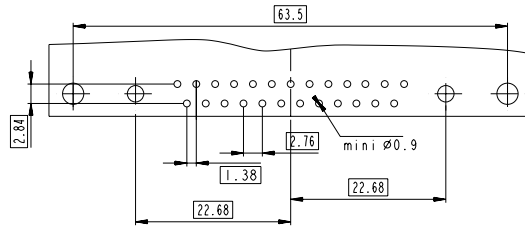

# 21WA4

## LAYOUT AND CONNECTOR DIMENSIONS

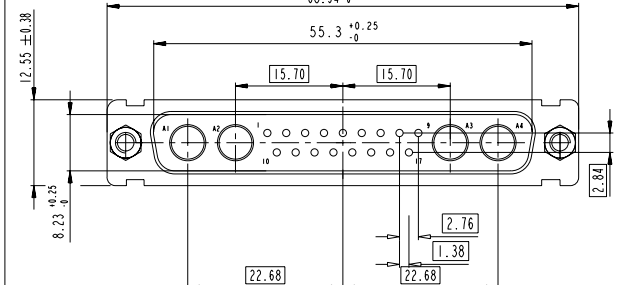
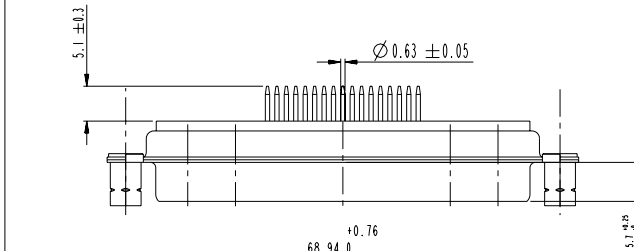
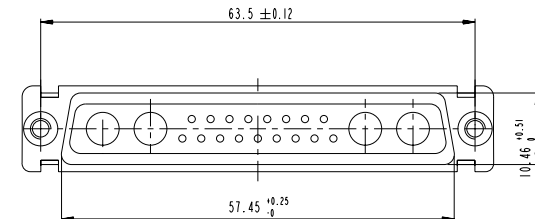
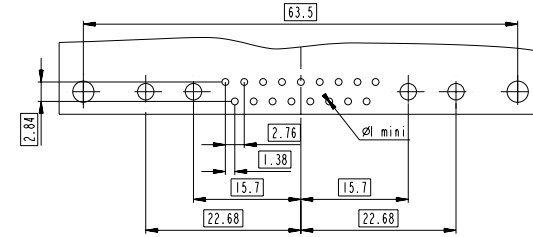

www.fciconnect.com		surface -	tolerance std	projection	mm
		ISO 1302	ISO 406 ISO 1101		
		TOLERANCES UNLESS OTHERWISE SPECIFIED			
Dr	M PESSON	2006/11/15	ANGULAR	0.X ± 0.3	size A2 Scale 2:1
Eng	P LEGARE	2006/11/15	LINEAR	0.XX ± 0.1	ECN LS07-0273
Chr	P LEGARE	2006/11/15	0° ± 2°	0.XXX ± 0.05	Product family
Appr	P LEGARE	2006/11/15			Spec ref
		SUB MALE DMW		ang no	C01-8637-1752
		mixed power straight solder		Rev.	B
		catalog no		CUSTOMER	sheet 5 of 7

Copyright FCI.

25W3

LAYOUT AND CONNECTOR DIMENSIONS

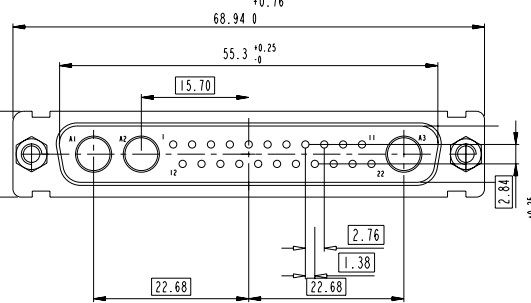
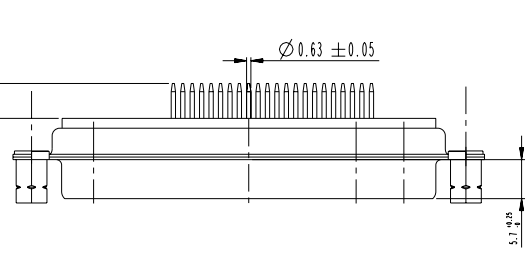
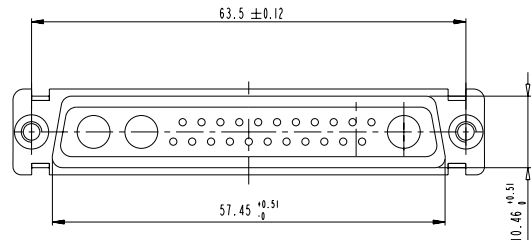
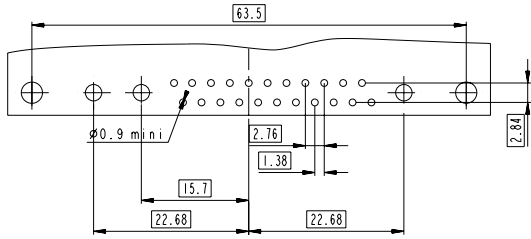

Floating signal contacts

24W7

LAYOUT AND CONNECTOR DIMENSIONS

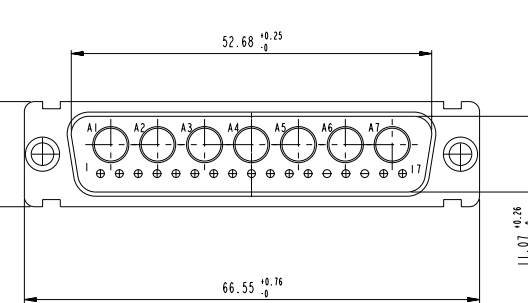
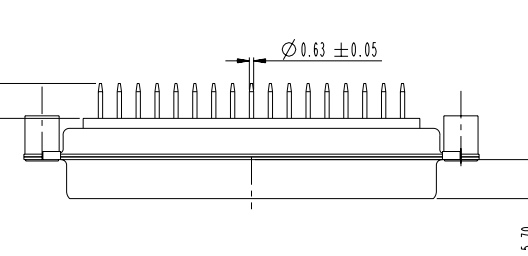
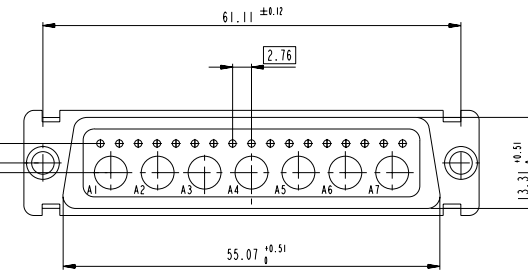
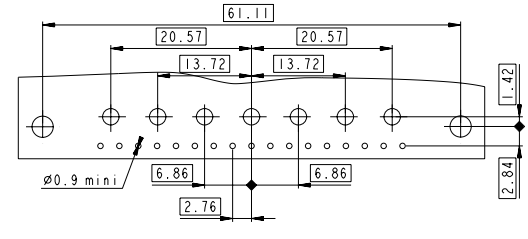

SIDE VIEW FOR LAYOUT: D

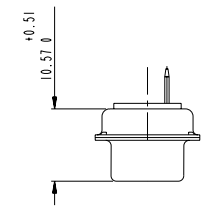

Copyright FCI

www.fciconnect.com		surface ISO 1302	tolerance std ISO 406 ISO 1101	projection mm
		TOLERANCES UNLESS OTHERWISE SPECIFIED		
Dr	M PESSON	2006/11/15	ANGULAR	LINEAR
Eng	P LEGARE	2006/11/15	0.xx ±0.3	size A2 Scale 2:1
Chr	P LEGARE	2006/11/15	0.xxx ±0.1	ECN LS07-0273
Appr	P LEGARE	2006/11/15	0' ±2'	0.xxx ±0.05
		Product family		- Spec ref
FCI		SUB MALE DMW		Rev. B
		mixed power straight solder		001-8637-1752
		catalog no		CUSTOMER sheet 6 of 7

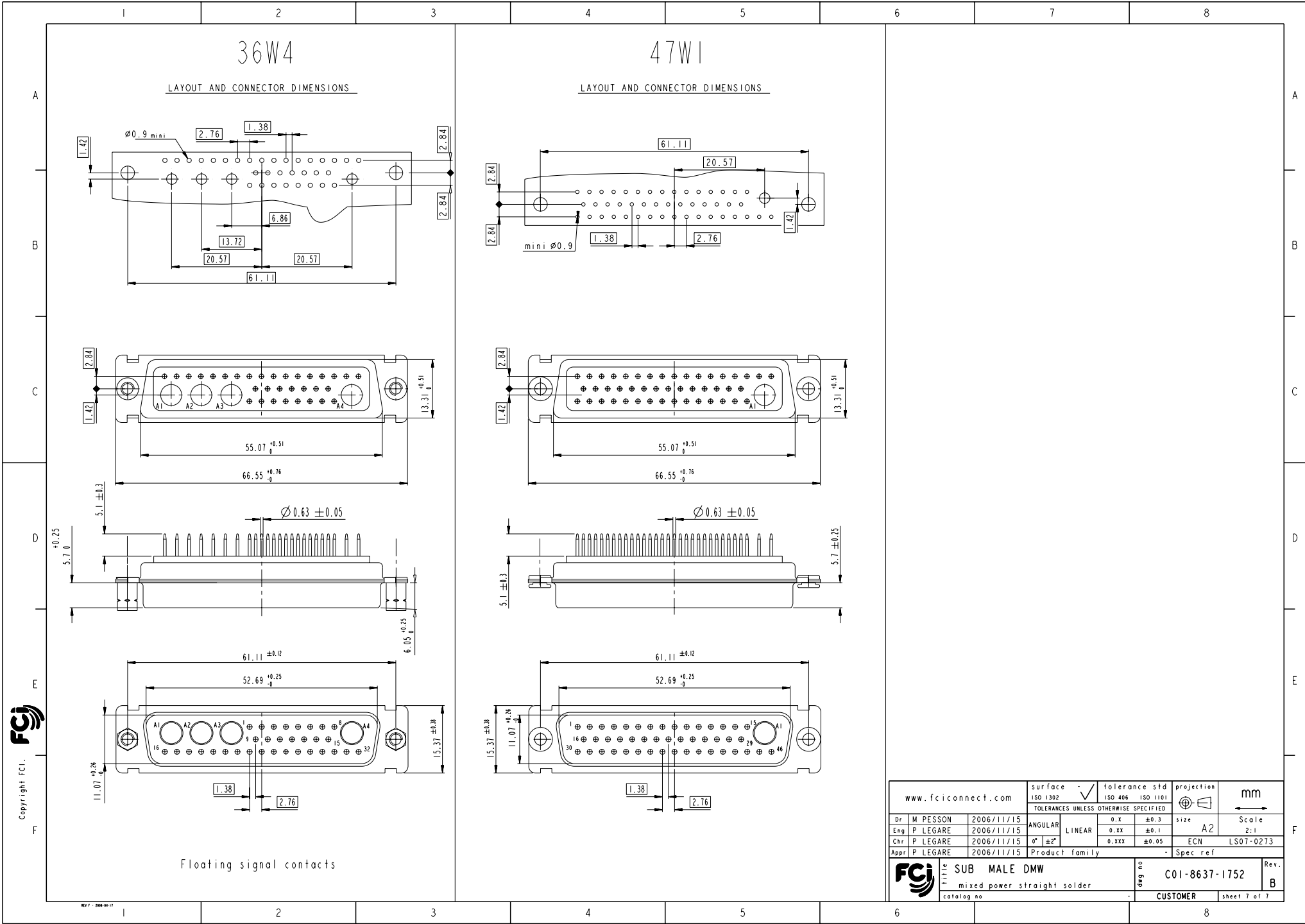

36W4

LAYOUT AND CONNECTOR DIMENSIONS

47W1

LAYOUT AND CONNECTOR DIMENSIONS

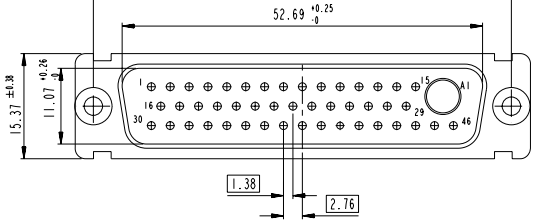
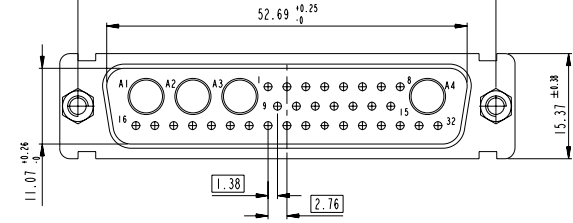
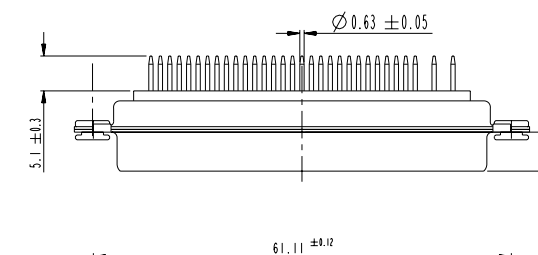
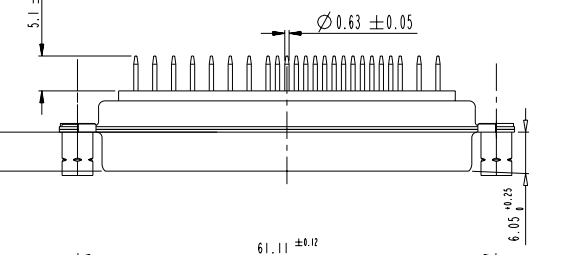
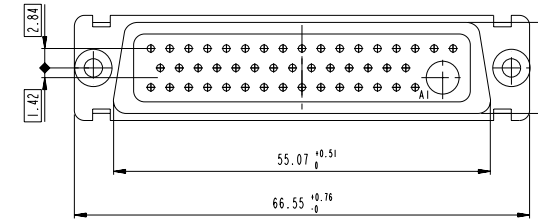
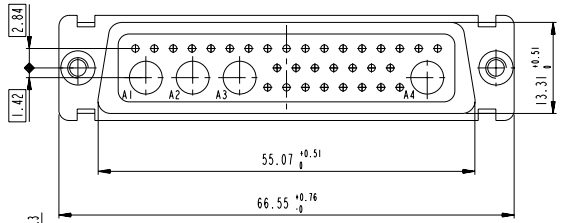
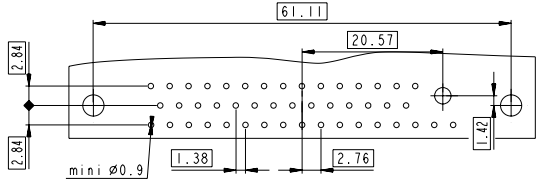
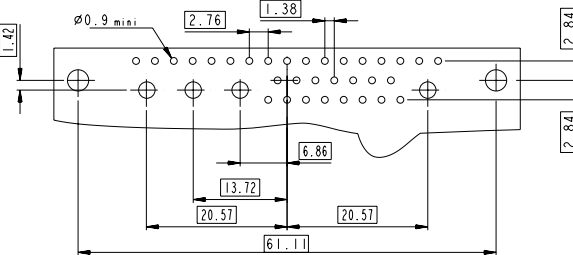

Floating signal contacts

www.fciconnect.com		surface	ISO 1302	tolerance std	ISO 406	ISO 1101	projection	mm
		TOLERANCES UNLESS OTHERWISE SPECIFIED						
Dr	M PESSON	2006/11/15	ANGULAR	0.X	±0.3		size	A2
Eng	P LEGARE	2006/11/15	LINEAR	0.XX	±0.1		Scale	2:1
Chr	P LEGARE	2006/11/15	0° ±2°	0.XXX	±0.05		ECN	LS07-0273
Appr	P LEGARE	2006/11/15	Product family				Spec ref	
		SUB MALE DMW		mixed power straight solder		cat no		C01-8637-1752
catalog no		CUSTOMER		sheet 7 of 7		Rev.		B

Copyright FCI.