

# PM SERIES

## U-shaped Micro Photoelectric Sensor

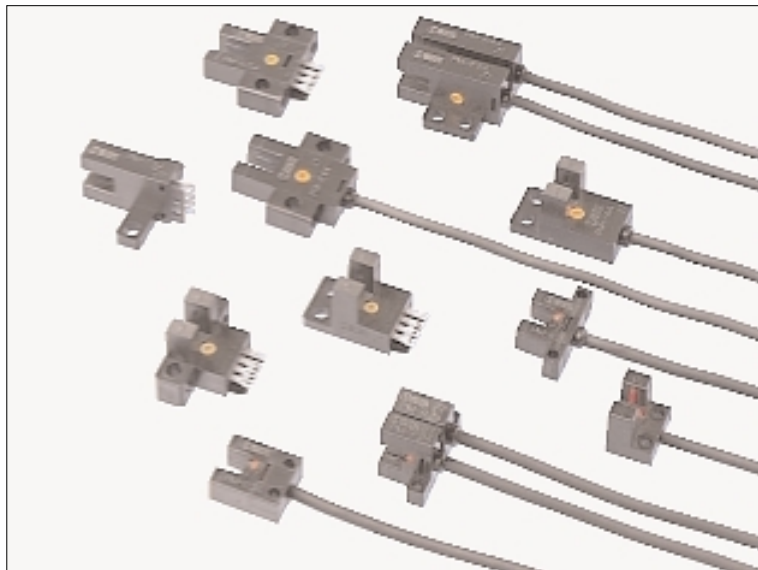

PNP output  
type available



**Extremely small size  
enables space saving  
and quick installation!**



Conforming to  
EMC Directive



UL Recognition

### Extremely small

Ultra-small type **PM-□24(-R)** contributes to the miniaturization of your equipment. Even the small cable type has become very compact.

Conventional  
model

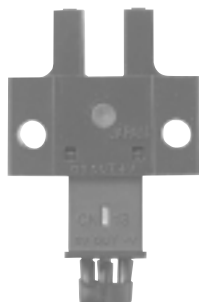

Ultra-small type  
PM-K24(-R)

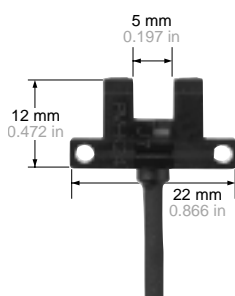

Small cable type  
PM-K44

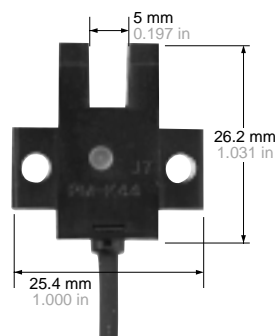

### Quick fitting hook-up connector

Easy to maintain connector type models are available. Its exclusive connector is the industry's first hook-up connector. Since only crimping with exclusive pliers is to be done, cumbersome soldering or insulation is absolutely not required. Further, connector attached cable is also available.

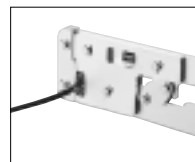

Crimp the connector  
on the cable.

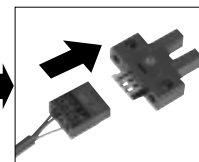

Quick connection to  
the sensor.

### Wide model variety

A wide variety of 17 shapes and 34 models is available. You may select from this wide range to suit the mounting conditions.

### Equipped with two independent outputs

All models are equipped with two independent outputs – Light-ON and Dark-ON. Hence, one model suffices even if the output is to be used differently, depending upon the location of use.

Also, since two independent outputs have been provided, cumbersome handling of the output conversion control input, or fear of logic inversion due to a cable break, is eliminated. The sensor can be connected to the existing wiring as it is.

#### Example of connection with a commercial intermediate connector

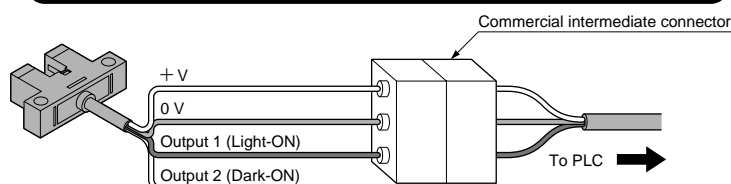

Just connect the cable of the used output (either Light-ON or Dark-ON).

Connected device side can be left as it is.

Note: Ensure to insulate the unused output wire.

### Meets global requirements

Conforms to Europe's EMC Directive and obtains UL Recognition.

Both, NPN and PNP output models are available.

**APPLICATIONS**

**Sensing the starting point on a rotating body**

The starting point can be sensed by making a slit in the rotating body.

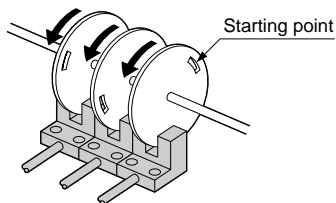

**Determining the pallet position**

Pallet is stopped by sensing the dog.

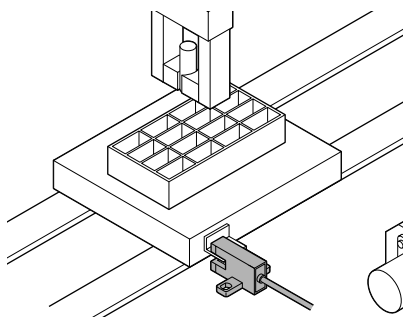

**Sensing the starting point and overrun of a moving body**

Starting point and overrun is sensed using the dog on the base.

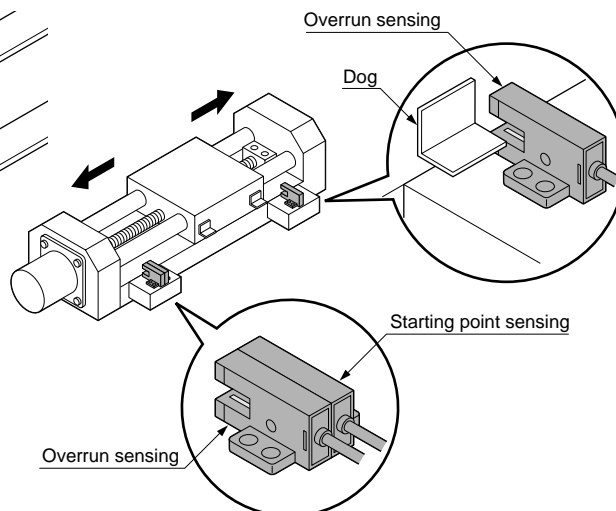

**ORDER GUIDE**

Type	Appearance (mm in)	Sensing range	Model No. (Note)	Output	Output operation
Ultra-small	<p>K type</p>	<p>5 mm 0.197 in (fixed)</p>	PM-K24	NPN open-collector transistor	Incorporated with 2 outputs: Light-ON / Dark-ON
			PM-K24-R		
	<p>L type</p>		PM-L24		
			PM-L24-R		
	<p>F type</p>		PM-F24		
			PM-F24-R		
	<p>R type</p>		PM-R24		
			PM-R24-R		
	<p>U type</p>		PM-U24		
			PM-U24-R		

Note: The suffix '-R' indicates a flexible cable type.

Amplifier Built-in  
CY  
PX-2  
RT-610  
MS-AJ  
Sensor Mounting Stand  
Micro  
PM  
PM2  
Multi-voltage  
NX5  
VF  
EQ-500

ORDER GUIDE

Type	Appearance (mm in)	Sensing range	Model No.	Output	Output operation	
Small	With cable	5 mm 0.197 in (fixed)	K type		<b>PM-K44</b>	NPN open-collector transistor
			T type		<b>PM-T44</b>	NPN open-collector transistor
			L type		<b>PM-L44</b>	NPN open-collector transistor
			Y type		<b>PM-Y44</b>	NPN open-collector transistor
			F type		<b>PM-F44</b>	NPN open-collector transistor
			R type		<b>PM-R44</b>	NPN open-collector transistor
			K type		<b>PM-K54</b>	NPN open-collector transistor
			T type		<b>PM-T54</b>	NPN open-collector transistor
			L type		<b>PM-L54</b>	NPN open-collector transistor
	With connector		Y type		<b>PM-Y54</b>	NPN open-collector transistor
			F type		<b>PM-F54</b>	NPN open-collector transistor
			R type		<b>PM-R54</b>	NPN open-collector transistor
			K type		<b>PM-K44P</b>	PNP open-collector transistor
			T type		<b>PM-T44P</b>	PNP open-collector transistor
			L type		<b>PM-L44P</b>	PNP open-collector transistor
			Y type		<b>PM-Y44P</b>	PNP open-collector transistor
			F type		<b>PM-F44P</b>	PNP open-collector transistor
			R type		<b>PM-R44P</b>	PNP open-collector transistor
					Incorporated with 2 outputs: Light-ON / Dark-ON	

## ORDER GUIDE

### 3 m 9.843 ft cable length type

3 m 9.843 ft cable length type (standard : 1 m 3.281 ft) is also available.

#### • Table of Model Nos.

Type		Standard	3 m 9.843 ft cable length type	
Ultra-Small	K Type	<b>PM-K24</b>	<b>PM-K24-C3</b>	
	L Type	<b>PM-L24</b>	<b>PM-L24-C3</b>	
	F Type	<b>PM-F24</b>	<b>PM-F24-C3</b>	
	R Type	<b>PM-R24</b>	<b>PM-R24-C3</b>	
	U Type	<b>PM-U24</b>	<b>PM-U24-C3</b>	
Small With Cable	K Type	NPN out put	<b>PM-K44</b>	<b>PM-K44-C3</b>
		PNP out put	<b>PM-K44P</b>	<b>PM-K44P-C3</b>
	T Type	NPN out put	<b>PM-T44</b>	<b>PM-T44-C3</b>
		PNP out put	<b>PM-T44P</b>	<b>PM-T44P-C3</b>
	L Type	NPN out put	<b>PM-L44</b>	<b>PM-L44-C3</b>
		PNP out put	<b>PM-L44P</b>	<b>PM-L44P-C3</b>
	Y Type	NPN out put	<b>PM-Y44</b>	<b>PM-Y44-C3</b>
		PNP out put	<b>PM-Y44P</b>	<b>PM-Y44P-C3</b>
	F Type	NPN out put	<b>PM-F44</b>	<b>PM-F44-C3</b>
		PNP out put	<b>PM-F44P</b>	<b>PM-F44P-C3</b>
	R Type	NPN out put	<b>PM-R44</b>	<b>PM-R44-C3</b>
		PNP out put	<b>PM-R44P</b>	<b>PM-R44P-C3</b>

## OPTIONS

Designation	Model No.	Description
Connector	<b>CN-14</b>	Connector for soldering
Hook-up connector	<b>CN-14H</b>	This connector can be hooked-up on 0.08 to 0.2 mm <sup>2</sup> cable simply in one grip. Wire diameter: $\phi$ 0.7 to $\phi$ 1.2 mm $\phi$ 0.028 to $\phi$ 0.047 in
	<b>CN-14H-2</b>	Suitable for UL standard cable. This connector can be hooked-up on 0.18 to 0.22 mm <sup>2</sup> cable simply in one grip. Wire diameter: $\phi$ 1.2 to $\phi$ 1.52 mm $\phi$ 0.047 to $\phi$ 0.060 in
Connector attached cable	<b>CN-14H-C1</b>	Length: 1 m 3.281 ft Weight: 20 g approx. For the connector type, with 0.18 mm <sup>2</sup> 4-core cabtyre cable
	<b>CN-14H-C3</b>	Length: 3 m 9.843 ft Weight: 60 g approx. Cable diameter: $\phi$ 3.8 mm $\phi$ 0.150 in
Hook-up pliers	<b>CN-HP</b>	These are exclusive pliers for hook-up connectors <b>CN-14H</b> and <b>CN-14H-2</b> .
Mounting screw	<b>MS-M2</b>	Mounting screw with washers for the ultra-small type sensor (50 pcs. lot). It can mount securely as it is spring washer attached.

#### Connector • CN-14

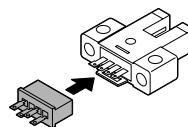

#### Hook-up connector • CN-14H • CN-14H-2

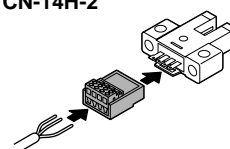

#### Connector attached cable • CN-14H-C1 • CN-14H-C3

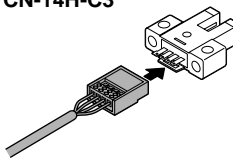

#### Hook-up pliers • CN-HP

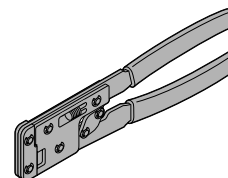

#### Mounting screw • MS-M2



Amplifier Built-in  
CY  
PX-2  
RT-610  
Sensor Mounting Stand  
MS-AJ  
Micro  
PM  
PM2  
NX5  
Multi-voltage  
VF  
EQ-500

## SPECIFICATIONS

Item	Model No.	Type	Ultra-small		Small	
		NPN output type	PM-□24	With flexible cable	With cable	With connector
		PNP output type		PM-□24-R	PM-□44	PM-□54
				PM-□44P	PM-□54P	
Sensing range		5 mm 0.197 in (fixed)				
Minimum sensing object		0.8 × 1.8 mm 0.031 × 0.071 in opaque object				
Hysteresis		0.05 mm 0.002 in or less				
Repeatability		0.03 mm 0.001 in or less				
Supply voltage		5 to 24 V DC ± 10 % Ripple P-P 10 % or less				
Current consumption		15 mA or less				
Output		<NPN output type> NPN open-collector transistor • Maximum sink current: 50 mA • Applied voltage: 30 V DC or less (between output and 0 V) • Residual voltage: 0.7 V or less (at 50 mA sink current) 0.4 V or less (at 16 mA sink current)		<PNP output type> PNP open-collector transistor • Maximum source current: 50 mA • Applied voltage: 30 V DC or less (between output and + V) • Residual voltage: 0.7 V or less (at 50 mA source current) 0.4 V or less (at 16 mA source current)		
Utilization category		DC-12 or DC-13				
Output operation		Incorporated with 2 outputs: Light-ON / Dark-ON				
Response time		Under light received condition: 20 μs or less Under light interrupted condition: 100 μs or less (Response frequency: 1 kHz or more)(Note 1)				
Operation indicator		Vermilion LED (lights up under light received condition)				
Pollution degree		3 (Industrial environment)				
Ambient temperature (Note 2, 3)		- 25 to + 55 °C - 13 to + 131 °F (No dew condensation or icing allowed), Storage: - 30 to + 80 °C - 22 to + 176 °F				
Ambient humidity		35 to 85 % RH, Storage: 35 to 85 % RH				
Ambient illuminance		Fluorescent light: 1,000 lx at the light-receiving face				
EMC		EN 50081-2, EN 50082-2, EN 60947-5-2				
Voltage withstandability		1,000 V AC for one min. between all supply terminals connected together and enclosure				
Insulation resistance		50 MΩ, or more, with 250 V DC megger between all supply terminals connected together and enclosure				
Vibration resistance		10 to 2,000 Hz frequency, 1.5 mm 0.059 in amplitude in X, Y and Z directions for two hours each				
Shock resistance		15,000 m/s <sup>2</sup> acceleration (1,500 G approx.) in X, Y and Z directions for three times each				
Emitting element		Infrared LED (non-modulated)				
Material		Enclosure: PBT, Slit cover: Polycarbonate, Terminal part [PM-□54(P) only]: Solder plated				
Cable		0.09 mm <sup>2</sup> 4-core cabtyre cable [PM-□24-R: 0.1 mm <sup>2</sup> flexible, oil and heat resistant cabtyre cable (Note 4)], 1 m 3.281 ft long				
Cable extension		Extension up to total 100 m 328.084 ft is possible with 0.3 mm <sup>2</sup> , or more, cable.				
Weight		10 g approx.		15 g approx.		3 g approx.

Notes: 1) The response frequency is the value when the disc, given in the figure below, is rotated.



2) In case the ultra-small type PM-□24(-R) is used at an ambient temperature of + 50 °C + 122 °F, or more, make sure to mount it on a metal body.

3) Take care that the flexibility of the PM-□24-R cable is lost if the ambient temperature is near - 10 °C + 14 °F.

4) The cable of PM-□24-R is a flexible cable usable on a moving base. When the sensor is mounted on a moving base, fix the sensor cable joint so that stress is not applied to it.

I/O CIRCUIT AND WIRING DIAGRAMS

PM-□24 PM-□24-R NPN output type  
PM-□44 PM-□54

I/O circuit diagram

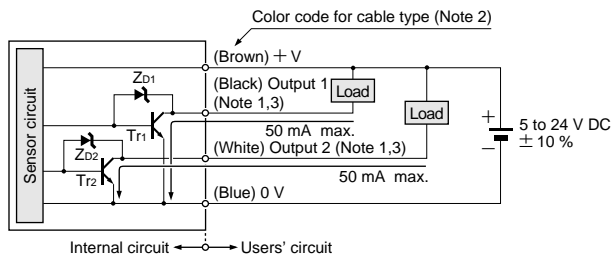

Wiring diagram

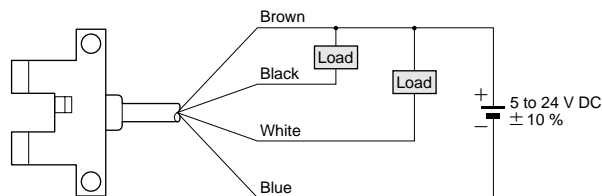

- Notes: 1) Make sure to connect terminals correctly as the sensor does not incorporate a reverse polarity protection circuit. Further, the output is not incorporated with a short-circuit protection circuit. Do not connect it directly to a power supply or a capacitive load. Faulty wiring may result in damage.  
2) The color code of the connector attached cable is also the same.  
3) Ensure to insulate the unused output wire.

Output operation

	Color code	Output operation
Output 1	Black	Light-ON
Output 2	White	Dark-ON

Symbols ... ZD1, ZD2: Surge absorption zener diode  
Tr1, Tr2 : NPN output transistor

PM-□44P PM-□54P PNP output type

I/O circuit diagram

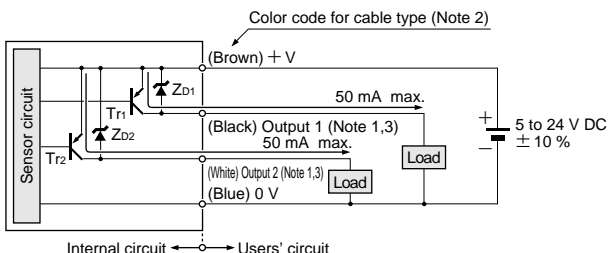

Wiring diagram

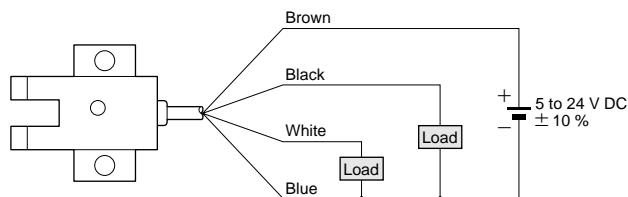

- Notes: 1) Make sure to connect terminals correctly as the sensor does not incorporate a reverse polarity protection circuit. Further, the output is not incorporated with a short-circuit protection circuit. Do not connect it directly to a power supply or a capacitive load. Faulty wiring may result in damage.  
2) The color code of the connector attached cable is also the same.  
3) Ensure to insulate the unused output wire.

Output operation

	Color code	Output operation
Output 1	Black	Light-ON
Output 2	White	Dark-ON

Symbols ... ZD1, ZD2: Surge absorption zener diode  
Tr1, Tr2 : PNP output transistor

SENSING CHARACTERISTICS (TYPICAL)

PM-24□(-R) Ultra small type

PM-□44(P) PM-□54(P) Small type

Sensing position

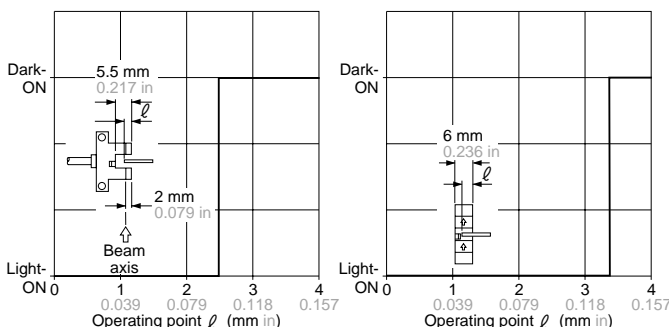

Sensing position

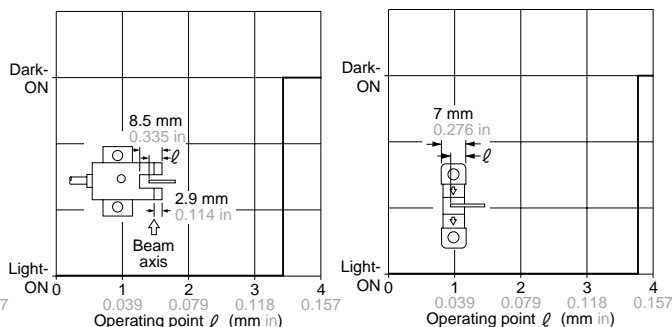

## PRECAUTIONS FOR PROPER USE

Refer to p.1135~ for general precautions.

### All models



This product is not a safety sensor. Its use is not intended or designed to protect life and prevent body injury or property damage from dangerous parts of machinery. It is a normal object detection sensor.



Make sure to connect terminals correctly as the sensor does not incorporate a reverse polarity protection circuit. Further, the output is not incorporated with a short-circuit protection circuit. Do not connect it directly to a power supply or a capacitive load. Faulty wiring may result in damage.

### Others

- Since the sensor is intended for use inside machines, no special counter-measures have been taken against extraneous light. Take care that extraneous light is not directly incident on the beam receiving section.

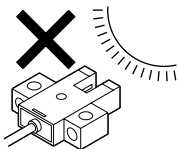

- Do not use during the initial transient time (50 ms) after the power supply is switched on.
- The cable of **PM-□24-R** is a flexible cable usable on a moving base. When the sensor is mounted on a moving base, fix the sensor cable joint so that stress is not applied to it.
- Take care that the flexibility of the **PM-□24-R** cable is lost if the ambient temperature is near  $-10\text{ }^{\circ}\text{C}$   $+14\text{ }^{\circ}\text{F}$ .

### Mounting

- When fixing the sensor with screws, use M3 screws [M2 screws in case of **PM-□24(-R)**] and the tightening torque should not exceed the values given below. Further, use small, round type plain washers. (M3:  $\phi 6\text{ mm}$   $\phi 0.236\text{ in}$ , M2:  $\phi 4.3\text{ mm}$   $\phi 0.169\text{ in}$ )

Model No.	Tightening torque
<b>PM-□24(-R)</b>	0.15 N·m
<b>PM-□44(P)</b>	0.5 N·m
<b>PM-□54(P)</b>	

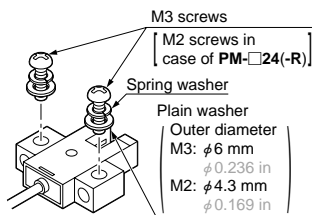

Note: In case the ultra-small type **PM-□24(-R)** is used at an ambient temperature of  $+50\text{ }^{\circ}\text{C}$   $+122\text{ }^{\circ}\text{F}$ , or more, make sure to mount it on a metal body.

### Cable extension

- Cable extension is possible up to an overall length of 100 m 328.084 ft with a  $0.3\text{ mm}^2$ , or more, cable. However, since a voltage drop shall occur due to the cable extension, ensure that the power supply voltage at the end of the cable attached to the sensor or at the sensor terminals is within the rating.

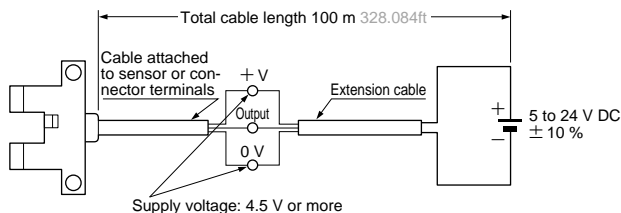

But, when the overall cable length, including the cable attached to the sensor, is as given below, there is no need to confirm the voltage.

Conductor cross-section area	Total cable length
$0.08\text{ to }0.1\text{ mm}^2$	Up to 5 m 16.404 ft
$0.2\text{ mm}^2$	Up to 10 m 32.808 ft
$0.3\text{ mm}^2$	Up to 20 m 65.617 ft

**PRECAUTIONS FOR PROPER USE**

Refer to p.1135~ for general precautions.

PM-□54  
PM-□54P

**Cautions in plugging or unplugging a connector**



- Do not plug or unplug a connector more than 10 times.
- Be sure not to give stress more than 5 N to a terminal of both a connector and a sensor. If you do not follow the above cautions, it will cause a poor contact.

**Procedures of plugging or unplugging a connector**

① Insert a connector straight into a sensor until the connector lug is locked by the sensor hook.

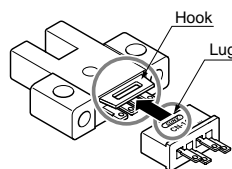

② When unplugging, give as much stress as a connector lug can be relieved from a hook. Then unplug it.

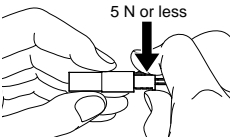

**Caution:** Be sure to hold a connector when plugging or unplugging it. Do not hold a terminal or a cable when plugging or unplugging the connector. Otherwise, it will cause a poor contact.

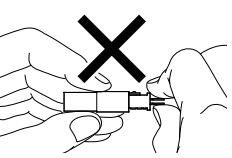

**Crimping of hook-up connectors CN-14H and CN-14H-2**

Item	Model No.	CN-14H	CN-14H-2
Conductor cross-section area		0.08 to 0.2 mm <sup>2</sup> (AWG28 to AWG24)	0.18 to 0.22 mm <sup>2</sup> (AWG25 to AWG24)
Wire diameter		φ0.7 to φ1.2 mm φ0.028 to φ0.047 in	φ1.2 to φ1.52 mm φ0.047 to φ0.060 in
Wire insulation material		Vinyl chloride or soft polyethylene	

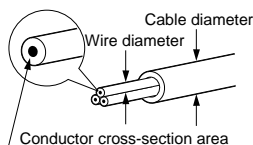

**Crimping method**

- ① Strip the cable sheath 15 mm 0.591 in, or more, and insert the wires into the connector insertion holes till the wire tips reach the end.

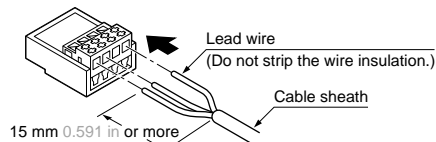

**Arrangement of connector terminals**

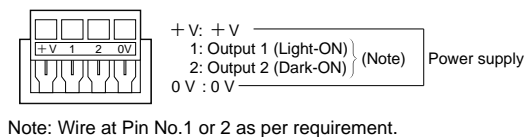

② Crimp with the exclusive hook-up pliers **CN-HP**.

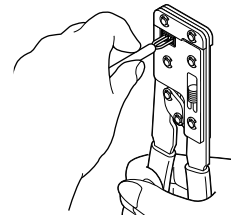

Notes: 1) When attaching or detaching the connector fitted with a cable, make sure to hold the connector firmly before proceeding.  
2) After crimping, do not pull on the cable.

**Caution:** Make sure to use the exclusive hook-up pliers **CN-HP**. Commercially available pliers cannot be used.

- Prior to using the sensor, affix the cable in a way as to avoid direct stress on the crimped part.

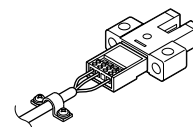

**Soldering (Both connector CN-14 and sensor)**

- If soldering is done directly on the terminals, strictly adhere to the conditions given below.

Soldering temperature	260 °C 500 °F or less
Soldering time	3 sec. or less
Soldering position	Refer to the below figure

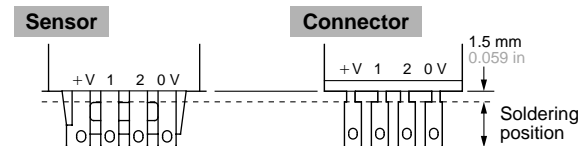

Amplifier Built-in  
CY  
PX-2  
RT-610  
Sensor Mounting Stand  
MS-AJ  
Micro  
PM  
PM2  
Multi-voltage  
VF  
NX5  
EQ-500



**DIMENSIONS (Unit: mm in)** The CAD data in the dimensions can be downloaded from the SUNX website: <http://www.sunx.co.jp/>

**PM-K24  
PM-K24-R** Sensor

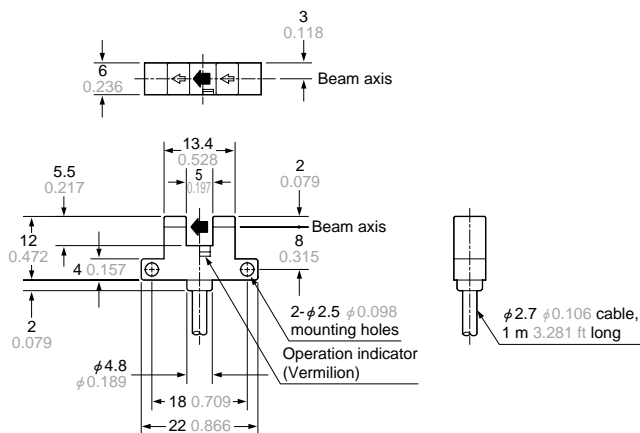

**PM-L24  
PM-L24-R** Sensor

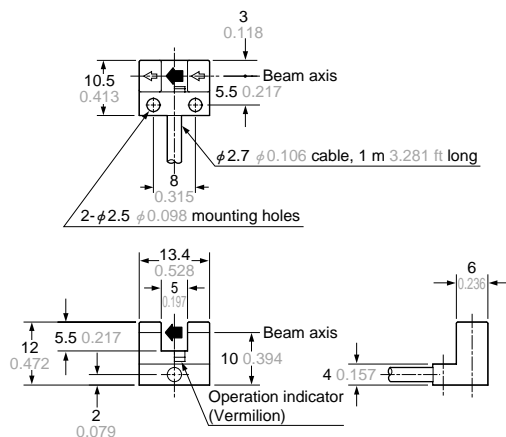

**PM-F24  
PM-F24-R** Sensor

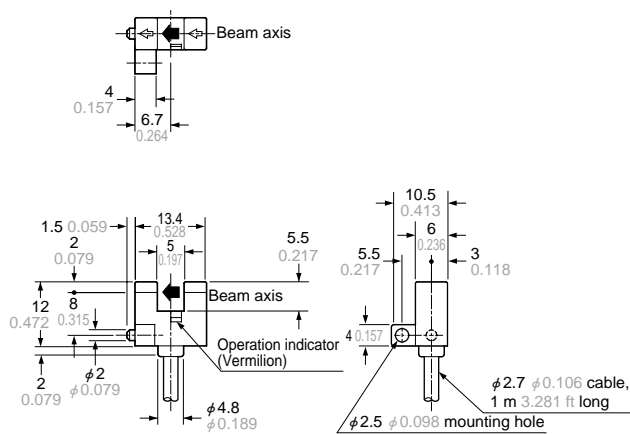

**PM-R24  
PM-R24-R** Sensor

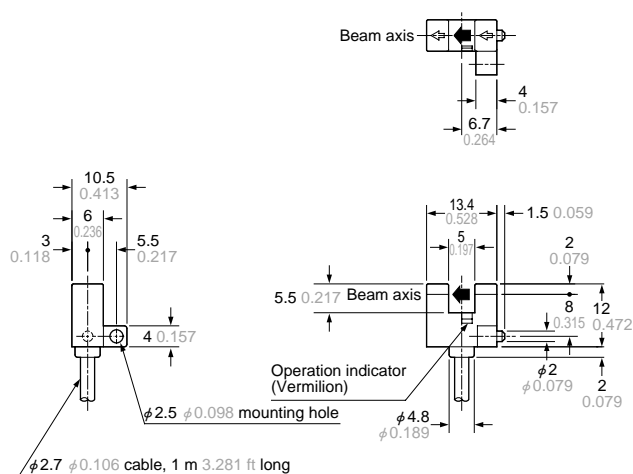

**PM-U24  
PM-U24-R** Sensor

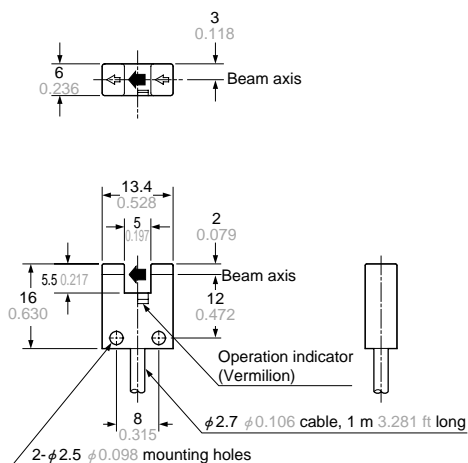

**PM-K44  
PM-K44P** Sensor

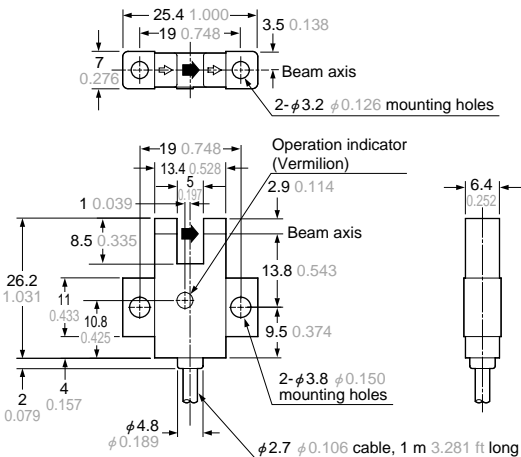

**DIMENSIONS (Unit: mm in)** The CAD data in the dimensions can be downloaded from the SUNX website: <http://www.sunx.co.jp/>

**PM-T44  
PM-T44P** Sensor

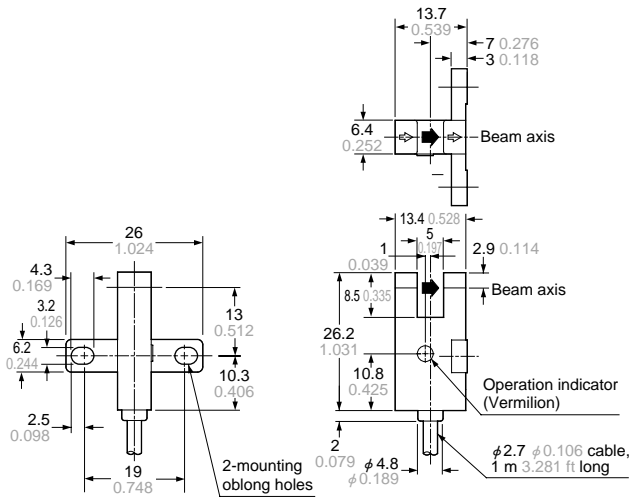

**PM-L44  
PM-L44P** Sensor

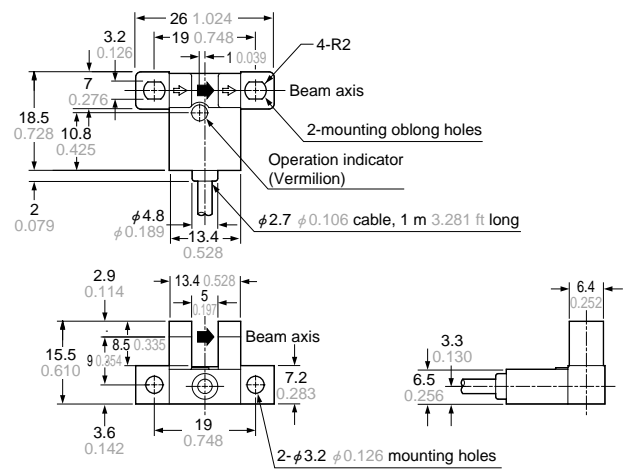

**PM-Y44  
PM-Y44P** Sensor

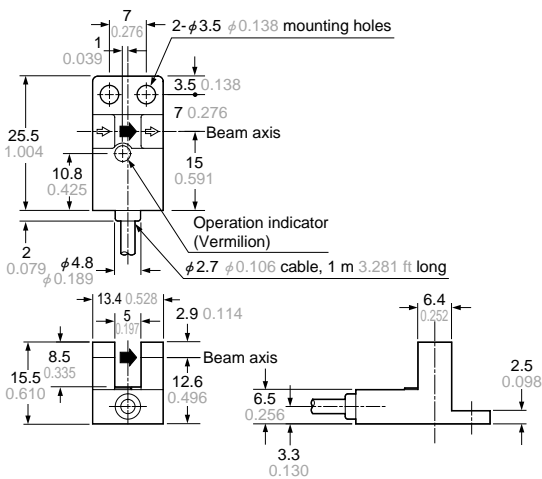

**PM-F44  
PM-F44P** Sensor

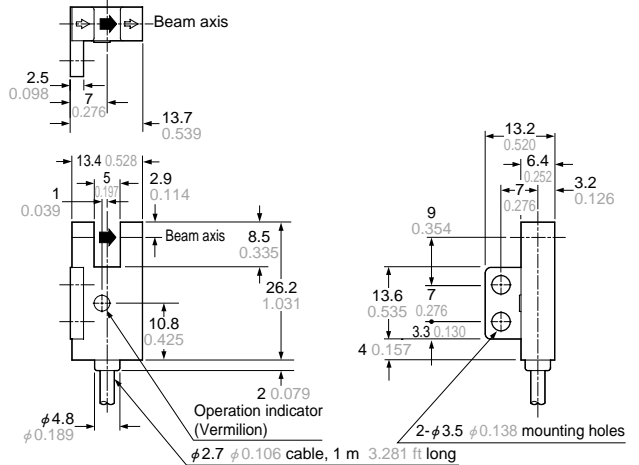

**PM-R44  
PM-R44P** Sensor

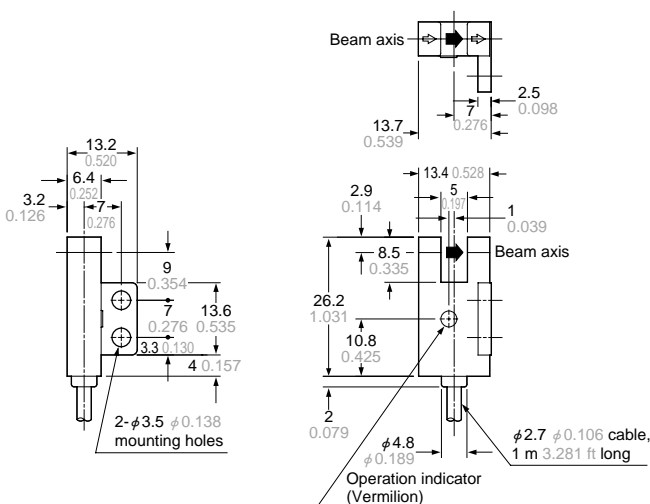

**PM-K54  
PM-K54P** Sensor

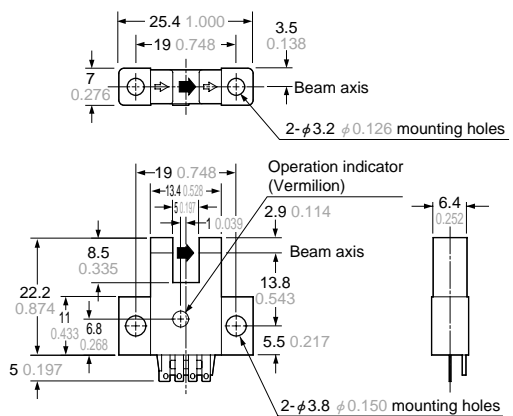

PHOTOELECTRIC SENSORS  
CY  
Amplifier Built-in  
PX-2  
RT-610  
Sensor Mounting Stand  
MS-AJ  
PM  
Micro  
PM2  
NX5  
Multi-voltage  
VF  
EQ-500

**DIMENSIONS (Unit: mm in)** The CAD data in the dimensions can be downloaded from the SUNX website: <http://www.sunx.co.jp/>

**PM-T54  
PM-T54P** Sensor

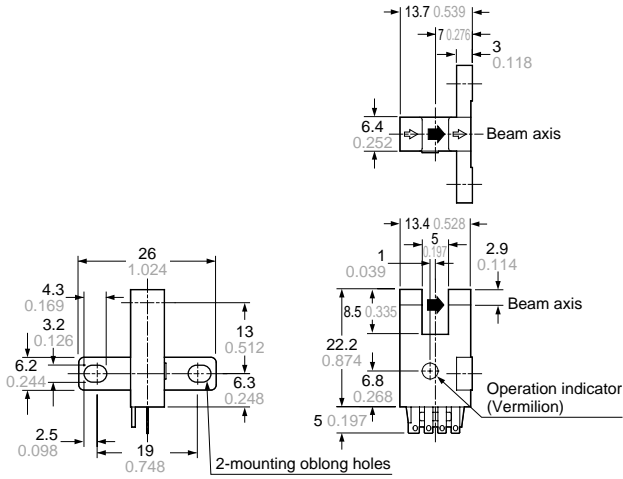

**PM-L54  
PM-L54P** Sensor

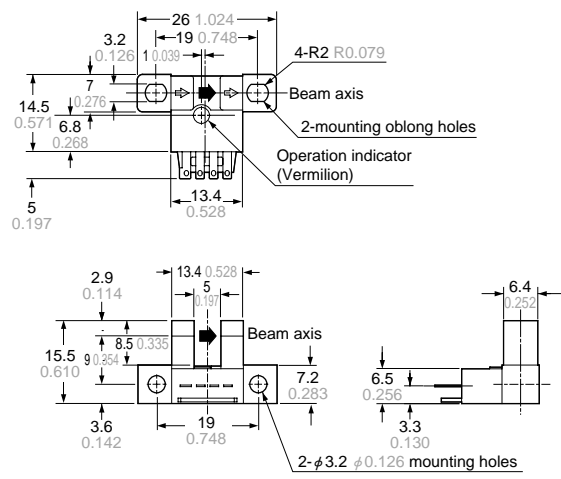

**PM-Y54  
PM-Y54P** Sensor

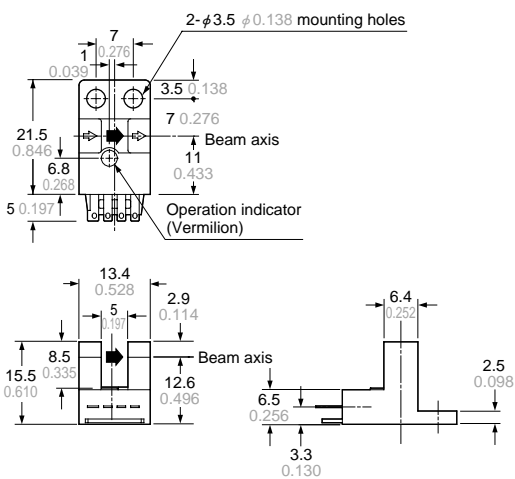

**PM-F54  
PM-F54P** Sensor

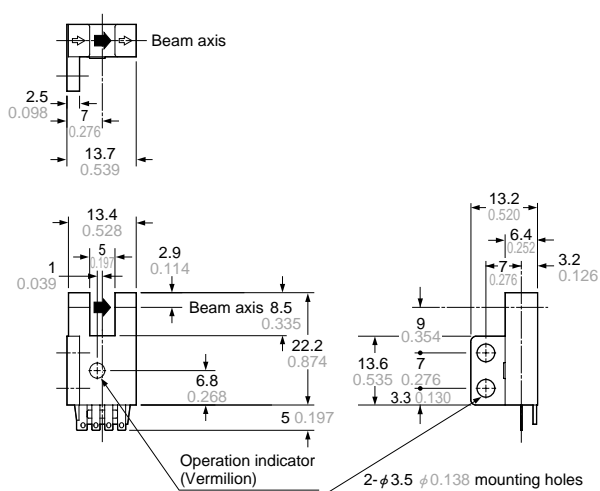

**PM-R54  
PM-R54P** Sensor

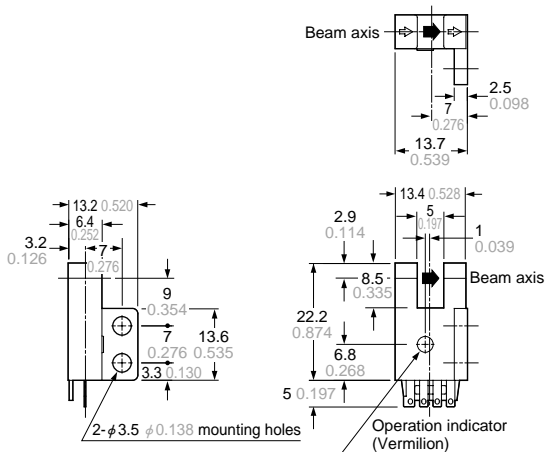

※Terminal part (PM-□54, PM-□54P)

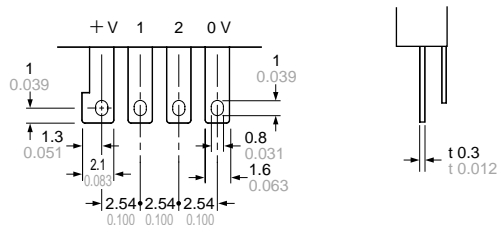

**DIMENSIONS (Unit: mm in)** The CAD data in the dimensions can be downloaded from the SUNX website: <http://www.sunx.co.jp/>

**CN-14** Connector (Optional)

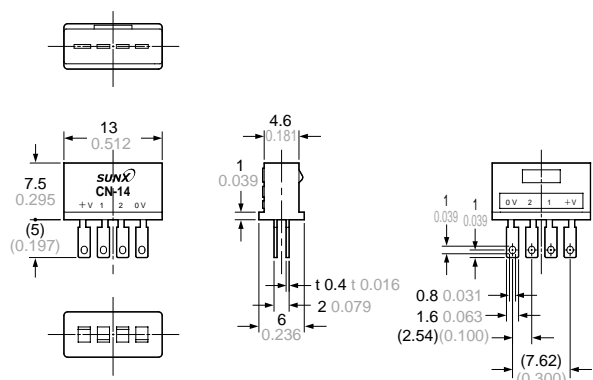

**CN-14H  
CN-14H-2** Hook-up connector (Optional)

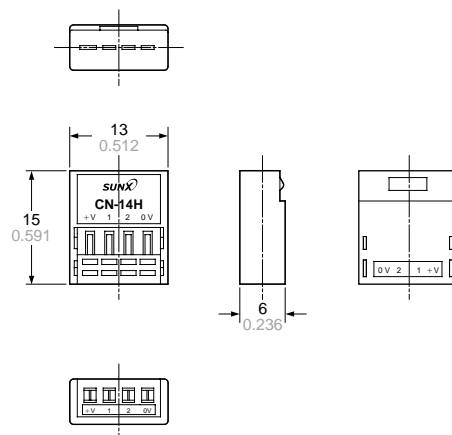

**CN-14H-C1  
CN-14H-C3** Connector attached cable (Optional)

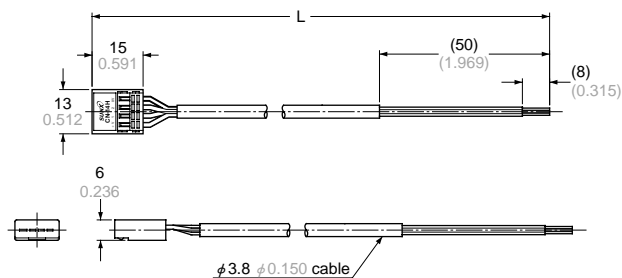

• Cable length L

Model No.	Cable length
CN-14H-C1	1 m 3.281 ft
CN-14H-C3	3 m 9.843 ft

Amplifier Built-in  
CY  
PX-2  
RT-610  
Sensor Mounting Stand  
MS-AJ  
Micro  
PM  
PM2  
Multi-voltage  
NX5  
VF  
EQ-500