

Female Signal Modules — Solder Termination — 4 Row

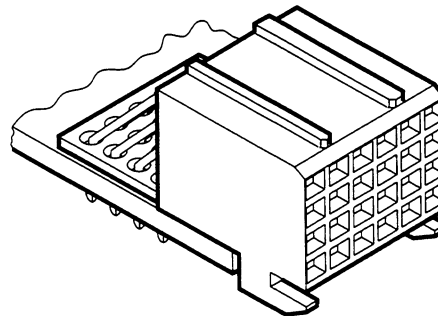

Features

- Designed to conform with IEC 48b237, EIAIs64, IEEE P896 Futurebus+, IEEE P1596 SCI and IEC 917 metric modular order
- Stackable with other TEMPUS modules, with no loss of positions
- Heat stake or pushfit peg retention
- High performance contacts, high hertz stress, 1000 cycles minimum
- 45° tails for mechanical stability and electrical performance
- High I/O, 20 contacts per linear centimetre (51 contacts per linear inch)
- High temperature materials, not affected by reflow solder process

Technical Data

Mechanical Data

Contact Pitch	2,00 x 2,00 (.079 x .079)
Polarisation	By design
Coding	With coding keys, see page 56
Housing Material	Liquid Crystal Polymer, UL94V-0
Termination	Solder tail, tin/lead plated
Termination p.t.h.	Ø 0,60 (.024), refer to page 65
Board Retention	Pushfit peg or heat stake
Contact Material	Phosphor bronze
Hertz Stress	1200 MPa (174 klb/sq.in.)
Class 1	1000 cycles minimum
Plating	Palladium Nickel plus Gold over Nickel
Insertion Force	0,45 N (1.6 oz) max. per contact
Withdrawal Force	0,15 N (0.5 oz) min. per contact

Electrical Data

Current Rating	1,50 A at 25°C, 1 A at 70°C
Withstanding Voltage	1000 Vrms
Insulation Resistance	Initial : 5000 MΩ After climatic test : 1000 MΩ
Contact Resistance	45 mΩ maximum

Female Signal Modules — Solder Termination — 4 Row

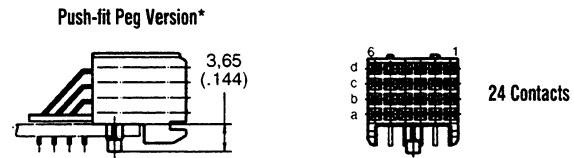

Heat Stake Version

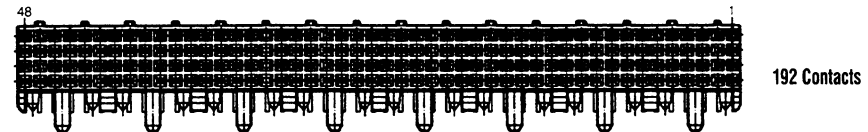
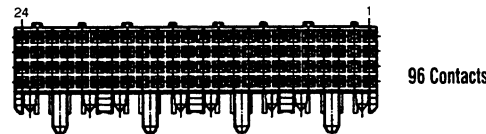
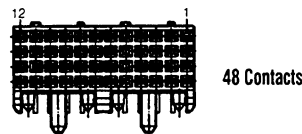
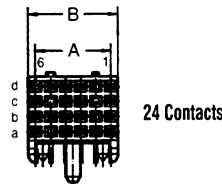
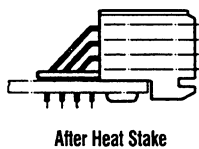
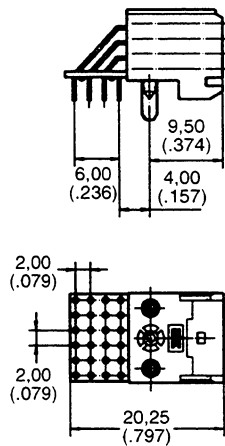

Recommended P.C.B. Hole Pattern, Component Side

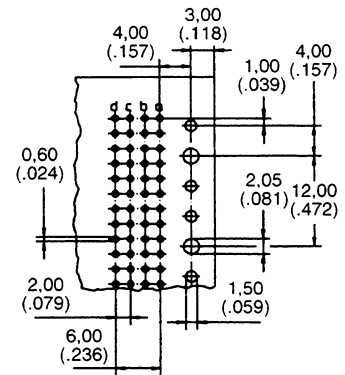

*Refer to Design Notes on page 65 for circuit board drill and hole plating details.

No. of Contacts	Part Numbers*		Board Thickness	A	B
	Pushfit Peg	Heat Stake			
24	CBC20P00-024FDS1-0-1-002	CBC20P00-024FDS1-0-1	1.60 (.063)	10.00 (.394)	11.95 (.470)
48	CBC20Q00-048FDS1-0-1-002	CBC20Q00-048FDS1-0-1	1.60 (.063)	22.00 (.866)	23.95 (.943)
96	CBC20R00-096FDS1-0-1-002	CBC20R00-096FDS1-0-1	1.60 (.063)	46.00 (1.811)	47.95 (1.888)
192	CBC20S00-192FDS1-0-1-002	CBC20S00-192FDS1-0-1	1.60 (.063)	94.00 (3.701)	95.95 (3.778)
24	CBC20P00-024FDS2-0-1-002	CBC20P00-024FDS2-0-1	2.40 (.094)	10.00 (.394)	11.95 (.470)
48	CBC20Q00-048FDS2-0-1-002	CBC20Q00-048FDS2-0-1	2.40 (.094)	22.00 (.866)	23.95 (.943)
96	CBC20R00-096FDS2-0-1-002	CBC20R00-096FDS2-0-1	2.40 (.094)	46.00 (1.811)	47.95 (1.888)
192	CBC20S00-192FDS2-0-1-002	CBC20S00-192FDS2-0-1	2.40 (.094)	94.00 (3.701)	95.95 (3.778)
24	CBC20P00-024FDS3-0-1-002	CBC20P00-024FDS3-0-1	3.20 (.126)	10.00 (.394)	11.95 (.470)
48	CBC20Q00-048FDS3-0-1-002	CBC20Q00-048FDS3-0-1	3.20 (.126)	22.00 (.866)	23.95 (.943)
96	CBC20R00-096FDS3-0-1-002	CBC20R00-096FDS3-0-1	3.20 (.126)	46.00 (1.811)	47.95 (1.888)
192	CBC20S00-192FDS3-0-1-002	CBC20S00-192FDS3-0-1	3.20 (.126)	94.00 (3.701)	95.95 (3.778)

Packaging Quantity

Contacts	In Tube	In Tray
24	44	286
48	22	143
96	11	65
192	5	26

All part numbers shown in this catalogue refer to connectors supplied in trays. For connectors supplied in tubes add the designation **-VR** to the end of the part number.

Note:
Minimum order quantities apply

Long pushfit peg (-002) enables fast assembly of the connector to the circuit board.

Pushfit peg (-002) is designed to work with wide wall modules and narrow wall modules incorporating a slot.

A short pushfit peg is available to work with narrow wall modules without a slot (replace -002 with -001).

* Part numbers in bold typefaces indicate standard products; usually available with shorter lead times.