



EVERLIGHT ELECTRONICS CO.,LTD.

# DATA SHEET

PART NO. : 1259-7SURSYGW/S530-A3

DATE : 2003/11/17

DEPARTMENT : CHR&D1

REVISION : 1

<b>RECEIVED</b>			
<input checked="" type="checkbox"/> MASS PRODUCTION			
<input type="checkbox"/> PRELIMINARY			
<input type="checkbox"/> CUSTOMER DESIGN			
DEVICE NUMBER : CDLE-125-191			
PAGE : 7			
CUSTOMER	DESIGNER	CHECKER	APPROVER
	<i>Handwritten signature</i>		

REV.	DESCRIPTION	RELEASE DATE

OFFICE: 7C BUILDING, LIAN HUA PORT INDUSTRIAL DISTRICT, LIAN HUA SHAN  
BONDED PRICESSING ZONE PAN YU, GUANG ZHU, CHINA

TEL : (020)84860913,84860914

FAX : (020)84860600

<http://www.everlight.com>



# Technical Data Sheet

## 3.0mm Multi-Color Round Type LED Lamps

1259-7SURSYGW/S530-A3

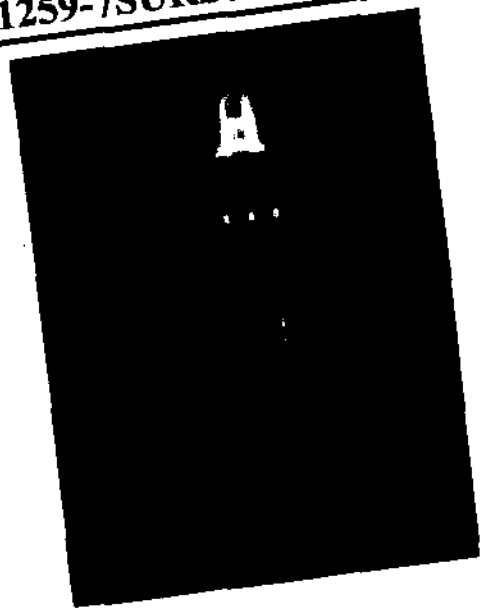

### ■ Features :

- Two chips are matched for uniform light output, wide viewing angle
- Long life-solid state reliability
- I.C. compatible/Low power consumption

### ■ Descriptions :

- The 1259-7 LED lamps contain two integral chips and is available as both bicolor and bipolar types.
- The Hyper Red and Super Yellow Green light is emitted by diodes of AlGaInP and AlGaInP respectively.
- Type of bipolar lamps are both White Diffused and Color Diffused while the bicolor are White Diffused

### ■ Applications :

- TV set
- Monitor
- Telephone
- Computer

PART NO.	Chip		Lens Color
	Material	Emitted Color	
1259-7SURSYGW/S530-A3	AlGaInP	Hyper Red	White Diffused
	AlGaInP	Super Yellow Green	

Technical Data Sheet  
 3.0mm Multi-Color Round Type LED Lamps

**1259-7SURSYGW/S530-A3**

**Package Dimensions**

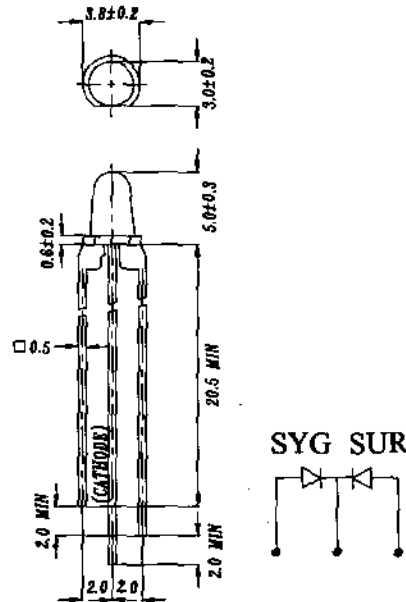

**Notes:** 1. All dimensions are in millimetres

- 2. An epoxy meniscus may extend about 1.5mm(0.059") down to the lead.
- 3. Tolerances unless Dimension  $\pm 0.25$ mm.

**Absolute Maximum Ratings at Ta = 25°C**

Parameter	Symbol	Rating		Unit
Forward Current	IF	SUR/S530	25	mA
		SYG/S530	25	
Operating Temperature	Topr	-40 to +85		°C
Storage Temperature	Tstg	-40 to +100		°C
Soldering Temperature	Tsol	260 ± 5		°C
Electrostatic Discharge	ESD	2000		V
Power Dissipation	Pd	SUR/S530	60	mW
		SYG/S530	60	
Peak Forward Current	IF(Peak)	SUR/S530	160	mA
		SYG/S530	160	
Reverse Voltage	VR	5		V

Note: \*1:IFP Conditions --Pulse Width  $\leq 1$ msec and Duty  $\leq 1/10$ .  
 \*2:Soldering time  $\leq 5$  seconds.



Technical Data Sheet  
3.0mm Multi-Color Round Type LED Lamps

**1259-7SURSYGW/S530-A3**

**Electro-Optical Characteristics (Ta=25°C)**

Parameter	Symbol	Min.	Typ.	Max.	Unit	Condition
Luminous Intensity	I <sub>v</sub>	SUR/S530	40	80	/	mcd I <sub>F</sub> = 20 mA
		SYG/S530	16	32	/	
Viewing Angle	2θ 1/2	/	60	/	deg	I <sub>F</sub> = 20 mA
Peak Wavelength	λ <sub>p</sub>	SUR/S530	/	632	/	nm I <sub>F</sub> = 20 mA
		SYG/S530	/	575	/	
Dominant Wavelength	λ <sub>d</sub>	SUR/S530	/	624	/	nm I <sub>F</sub> = 20 mA
		SYG/S530	/	573	/	
Spectrum Radiation Bandwidth	Δλ	SUR/S530	/	20	/	nm I <sub>F</sub> = 20 mA
		SYG/S530	/	20	/	
Forward Voltage	V <sub>F</sub>	SUR/S530	/	2.0	2.4	V I <sub>F</sub> = 20 mA
		SYG/S530	/	2.0	2.4	
Reverse Current	I <sub>R</sub>	/	/	10	μA	V <sub>R</sub> = 5 V



# Technical Data Sheet

## 3.0mm Multi-Color Round Type LED Lamps

### 1259-7SURSYGW/S530-A3

#### Typical Electro-Optical Characteristic Curves:

(SUR)

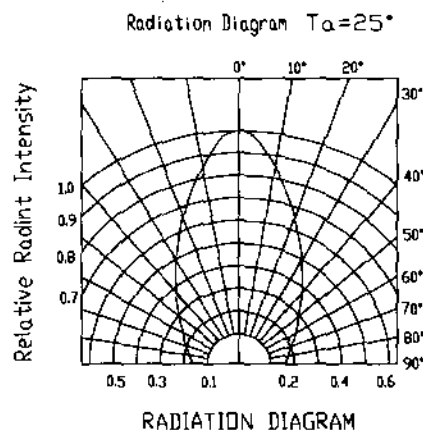
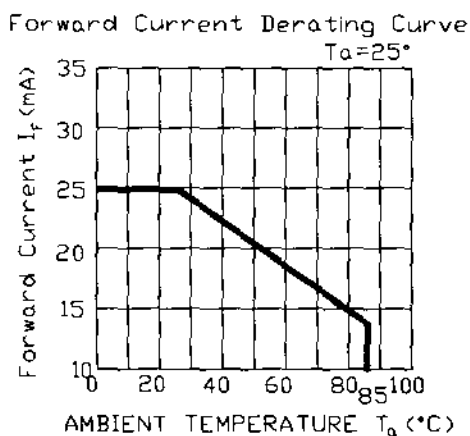
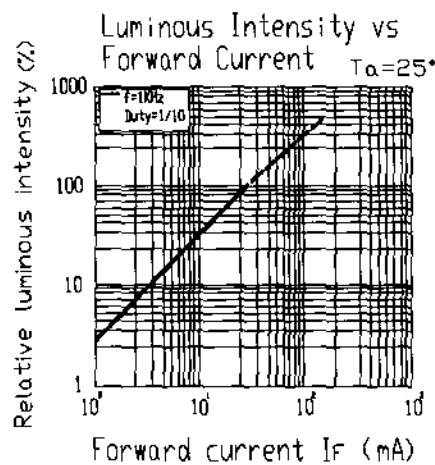
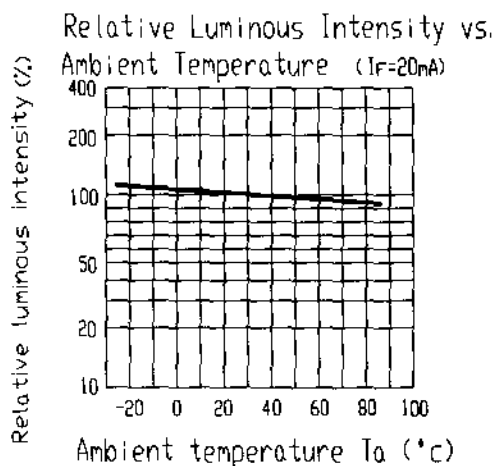
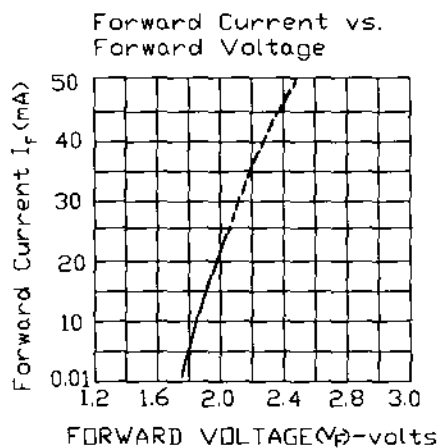
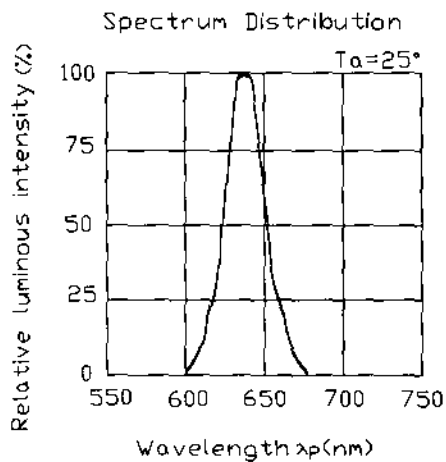



# Technical Data Sheet

## 3.0mm Multi-Color Round Type LED Lamps

**1259-7SURSYGW/S530-A3**

■ Typical Electro-Optical Characteristic Curves:

(SYG)

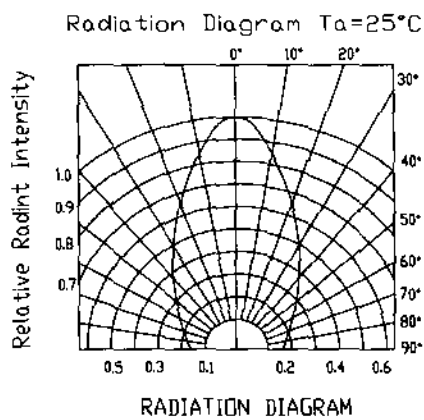
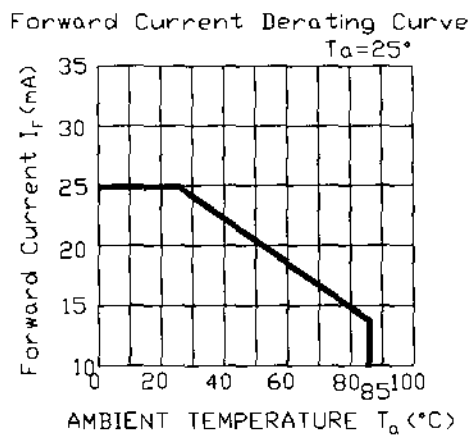
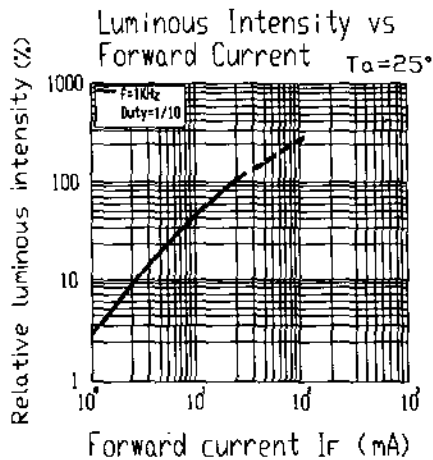
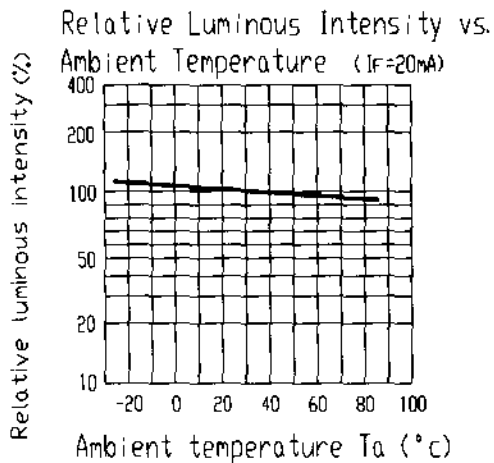
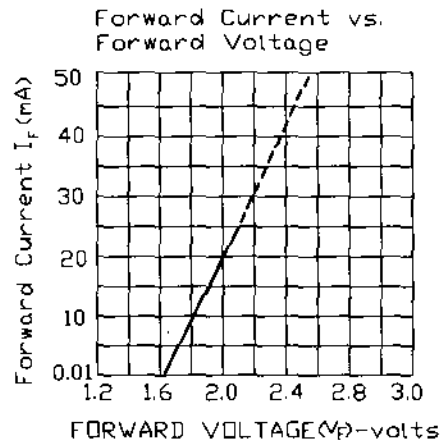
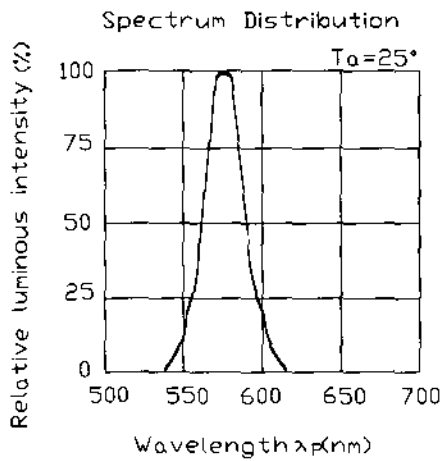

Technical Data Sheet  
3.0mm Multi-Color Round Type LED Lamps

**1259-7SURSYGW/S530-A3**

■ Reliability test items and conditions:

NO	Item	Test Conditions	Test Hours/Cycle	Sample Size	Ac/Re
1	Solder Heat	TEMP : 260°C ± 5 °C	10 SEC	76 PCS	0/1
2	Temperature Cycle	H : +100°C 15min § 5 min L : -40°C 15min	300 CYCLES	76 PCS	0/1
3	Thermal Shock	H : +100°C 5min § 10 sec L : -10°C 5min	300 CYCLES	76 PCS	0/1
4	High Temperature Storage	TEMP : 100°C	1000 HRS	76 PCS	0/1
5	Low Temperature Storage	TEMP : -40°C	1000 HRS	76 PCS	0/1
6	DC Operating Life	TEMP : 25°C IF = 20mA	1000 HRS	76 PCS	0/1
7	High Temperature / High Humidity	85°C / 85% RH	1000 HRS	76 PCS	0/1



# Technical Data Sheet

## 3.0mm Multi-Color Round Type LED Lamps

**1259-7SURSYGW/S530-A3**

### Packing Quantity Specification

1.1000PCS/1Bag , 6Bags/1Box

2.10Boxes/1Carton

### Label Form Specification

**EVERLIGHT**

CPN:

P/N:



1259-7SURSYGW/S530-A3

QTY:



CAT:

HUE:

REF:

LOT NO: EL



MADE IN TAIWAN

CPN: Customer's Production Number

P/N : Production Number

QTY: Packing Quantity

CAT: Ranks

HUE: Peak Wavelength

REF: Reference

LOT No: Lot Number

MADE IN TAIWAN: Production Place

### Notes

1. Above specification may be changed without notice. EVERLIGHT will reserve authority on material change for above specification.
2. When using this product, please observe the absolute maximum ratings and the instructions for using outlined in these specification sheets. EVERLIGHT assumes no responsibility for any damage resulting from use of the product which does not comply with the absolute maximum ratings and the instructions included in these specification sheets.
3. These specification sheets include materials protected under copyright of EVERLIGHT corporation. Please don't reproduce or cause anyone to reproduce them without EVERLIGHT's consent.

EVERLIGHT ELECTRONICS CO., LTD.

Office: No 25, Lane 76, Sec 3, Chung Yang Rd,

Tucheng, Tainei 236, Taiwan, R.O.C.

Tel: 886-2-2267-2000, 2267-9936

Fax: 886-2267-6244, 2267-6189, 2267-6306

<http://www.everlight.com>