

RJ45 TELEPHONE JACK INDICATORS

ROUND / RECTANGULAR LEDs TWO ELEMENTS

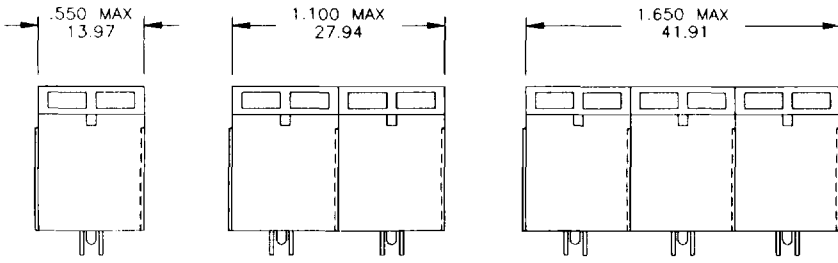

AVAILABLE WITH EITHER RECTANGULAR OR ROUND LEDs. REFER TO PART NUMBERS AT DETAILS (CENTER LEFT OF PAGE).

TABLE 1

CODE	COLOR	XP nm
1	ULTRA RED	660
2	HI-EFF RED	635
3	ORANGE	605
4	YELLOW	585
6	GREEN	565
8	BLUE	470
G	ULTRA GREEN	565
Y	ULTRA YELLOW	590

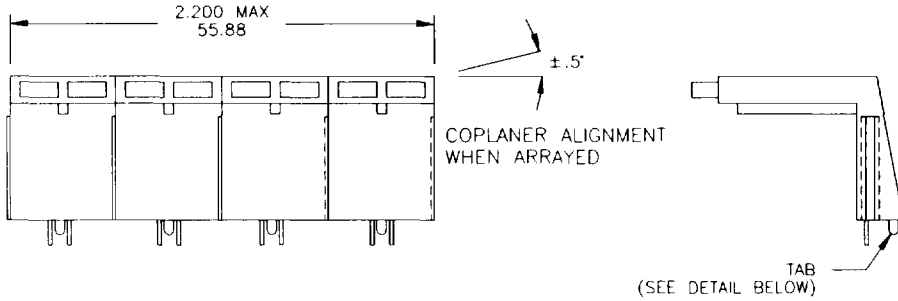

RECTANGULAR LEDs

PCB-1201-X0X

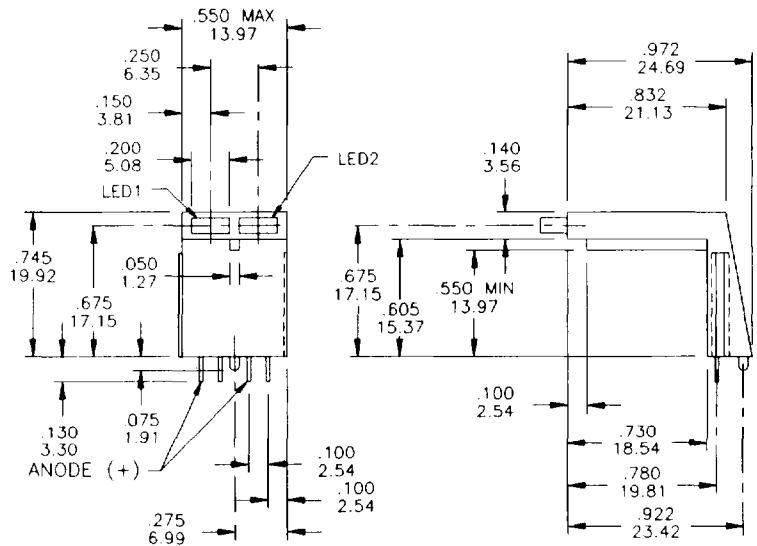
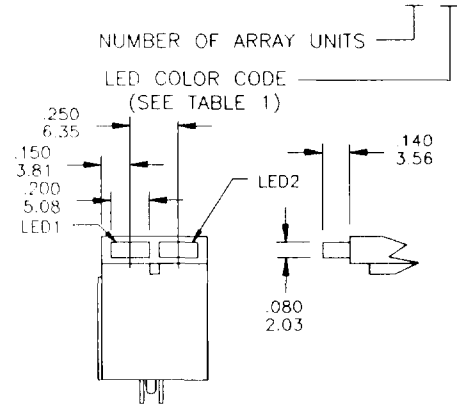

ROUND LEDs

PCB-1202-X0X

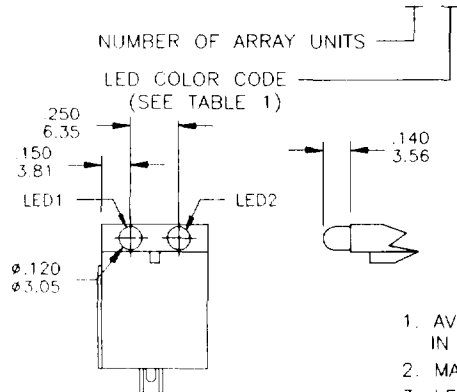

TAB DETAIL

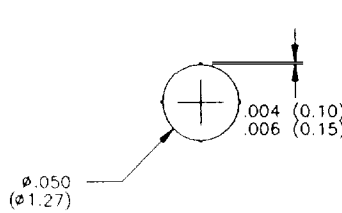

PCB LAYOUT

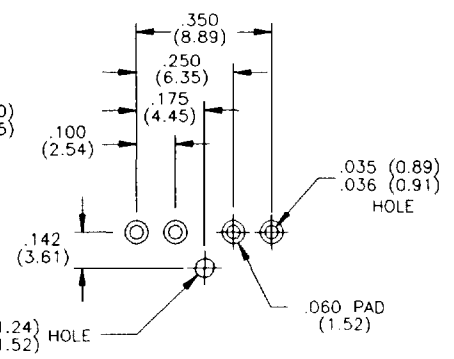

1. AVAILABLE AS LOW CURRENT (2mA)LEDs IN ULTRA COLORS ONLY.
2. MATERIAL IS BLACK NYLON 66 UL94V-0
3. LED 1 AND LED 2 MAY BE DIFFERENT COLORS, CALL FACTORY FOR PART NUMBERS.

(VIEW FROM UNDERSIDE OF BOARD)