

PBA series

Piezo switches Ø 19 (.748)

Overview

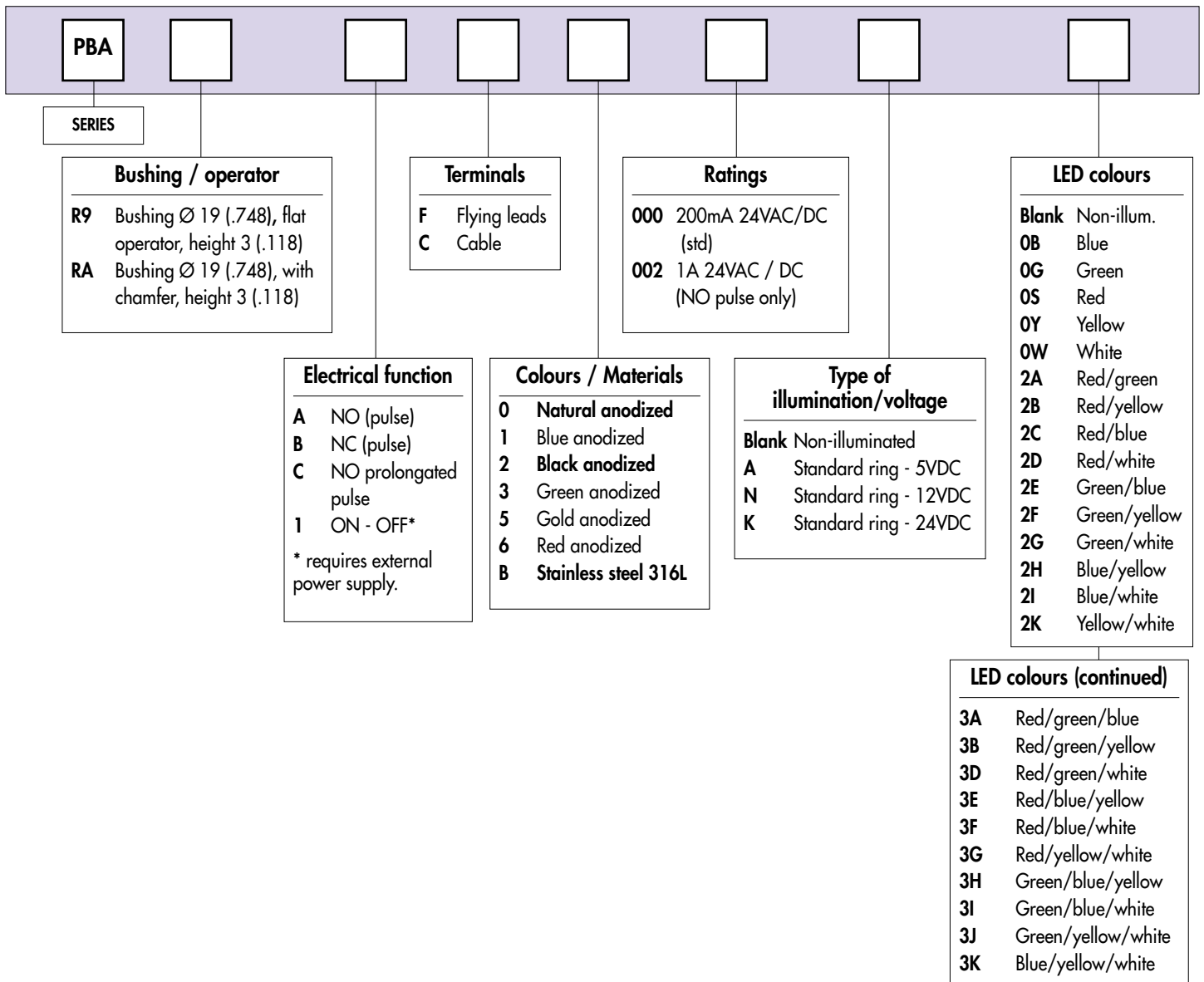

For options not listed above, please refer to our "Custom configurations" pages.



NOTICE : please note that not all combinations of above numbers are available. Refer to the following pages for further information.



Mounting accessories : standard hardware supplied : 1 hex nut U6450 (22 mm ac. flats) and 1 O-ring



Packaging unit : 20 pieces

PBA series

Piezo switches Ø 19 (.748)

Illuminated and non-illuminated

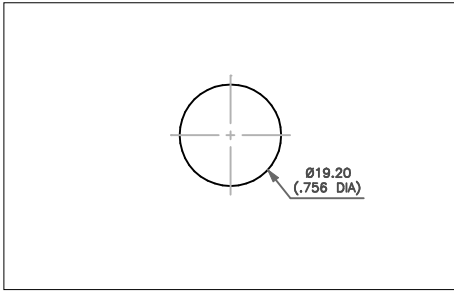

- Operator Ø 22 mm (.866)

Shown with flying lead terminals.

MODEL
STRUCTURE

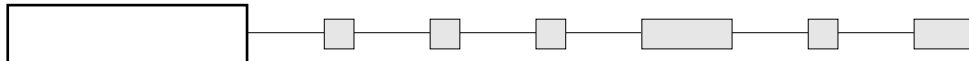

Non-illuminated - operator height 3 mm (.118)



PBARAAF1000

Flat
PBAR9

With chamfer
PBARA

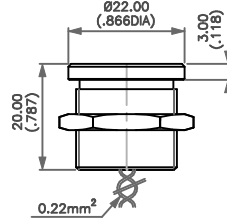

R9

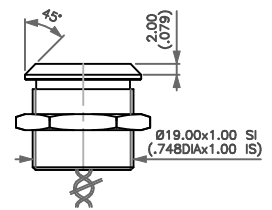

RA

With standard illuminated ring - operator height 3 mm (.118)



PBAR9AF0000A0S

Flat
PBAR9

With chamfer
PBARA

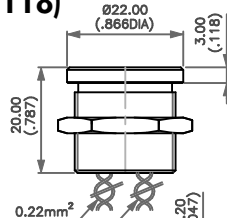

R9

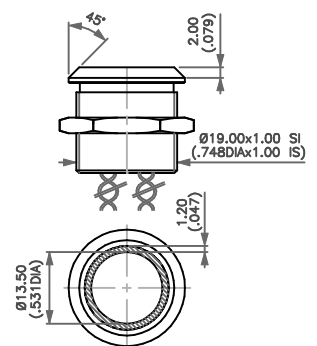

RA

Wire colours : see "Electrical functions" page.

ELECTRICAL FUNCTION

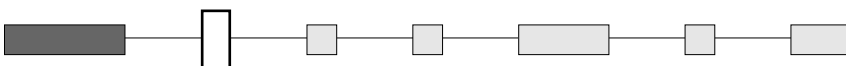

- A NO pulse
- B NC pulse
- C NO prolonged pulse
- 1 ON - OFF - Requires external power supply.

PBA series

Piezo switches Ø 19 (.748)

Options

TERMINALS

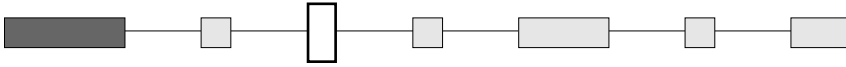

F Flying leads
C Cable

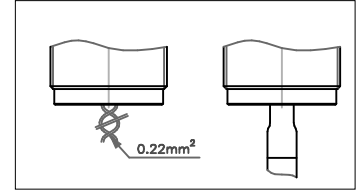

CASE COLOURS / MATERIALS

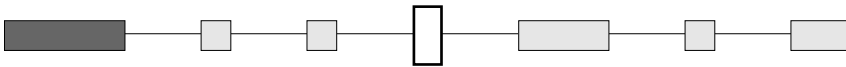

| Code | Colour |
|------|----------------------------|
| 0 | Natural anodized aluminium |
| 1 | Blue anodized aluminium |
| 2 | Black anodised aluminium |

| Code | Colour |
|------|--------------------------|
| 3 | Green anodized aluminium |
| 5 | Gold anodized aluminium |
| 6 | Red anodised aluminium |

| Code | Colour |
|------|----------------------|
| B | Stainless steel 316L |



RATINGS

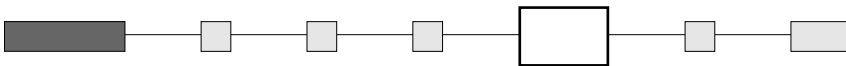

000 200mA 24VAC or DC (standard)
002 1A 24VAC or DC (NO pulse only)

TYPE OF ILLUMINATION / VOLTAGE

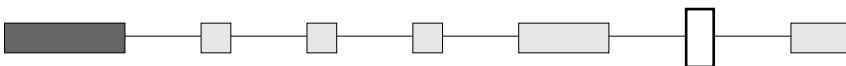

| | 5VDC | 12VDC | 24VDC |
|---|------|-------|-------|
| ○ | A | N | K |

PBA series

Piezo switches Ø 19 (.748)

Options

LED COLOURS

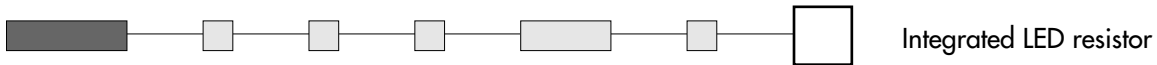

Blank : non-illuminated

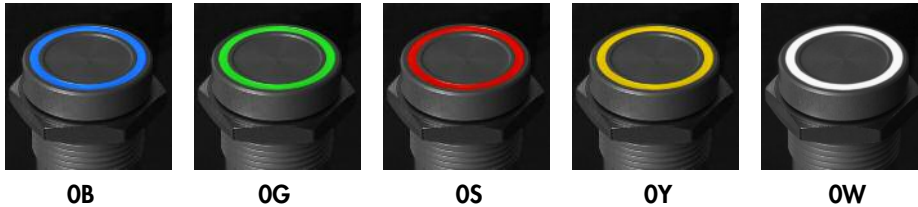

Illuminated 1 LED *

OB : blue - **OG** : green - **OS** : red - **OY** : yellow - **OW** : white

Illuminated 2 LEDs

2A : red/green - **2B** : red/yellow - **2C** : red/blue - **2D** : red/white - **2E** : green/blue - **2F** : green/yellow - **2G** : green/white
2H : blue/yellow - **2I** : blue/white - **2K** : yellow/white

Illuminated 3 LEDs

3A : red/green/blue - **3B** : red/green/yellow - **3D** : red/green/white - **3E** : red/blue/yellow - **3F** : red/blue/white
3G : red/yellow/white - **3H** : green/blue/yellow - **3I** : green/blue/white - **3J** : green/yellow/white - **3K** : blue/yellow/white

* LED colour is indicated by the bottom of the product.