

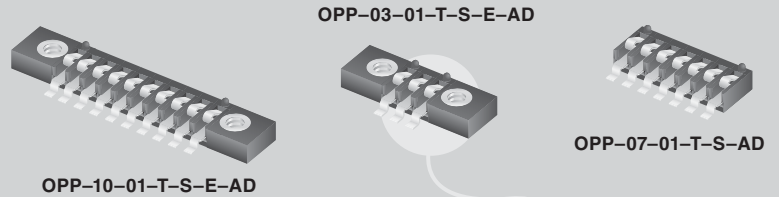

(2,54mm) .100"

OPP SERIES



# ONE PIECE POWER INTERCONNECT

## SPECIFICATIONS

For complete specifications and recommended PCB layouts see [www.samtec.com?OPP](http://www.samtec.com?OPP)

**Insulator Material:**

Black Liquid Crystal Polymer



**Contact Material:**

BeCu

**Plating:**

Sn over 50µ" (1,27µm) Ni

**Operating Temp Range:**

-55°C to +105°C

**Current Rating:**

5A @ 75°C ambient

**Voltage Rating:**

600 VAC

**RoHS Compliant:**

Yes

**Processing:**

**Max Processing Temp:**

230°C for 60 seconds, or

260°C for 20 seconds 3x

**Lead-Free Solderable:**

Yes

**SMT Lead Coplanarity:**

(0,15mm) .006" max

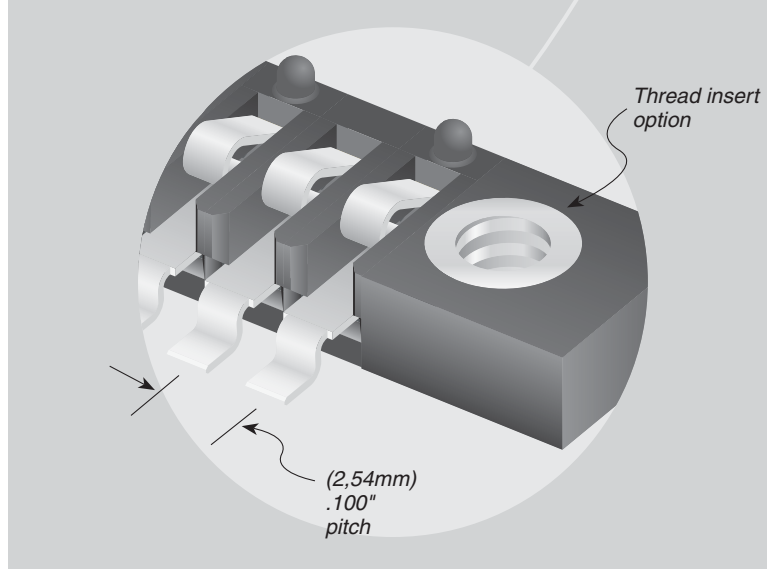

## APPLICATION SPECIFIC OPTION

Alternative alignment pin available.  
Call Samtec.

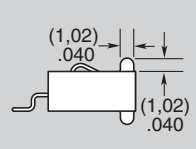
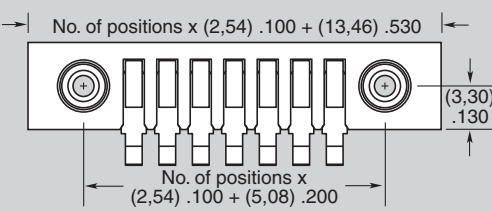
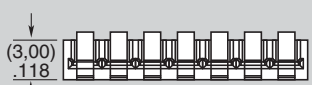
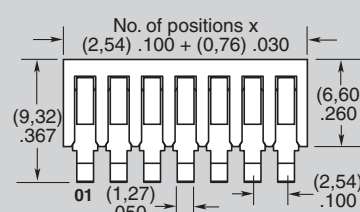
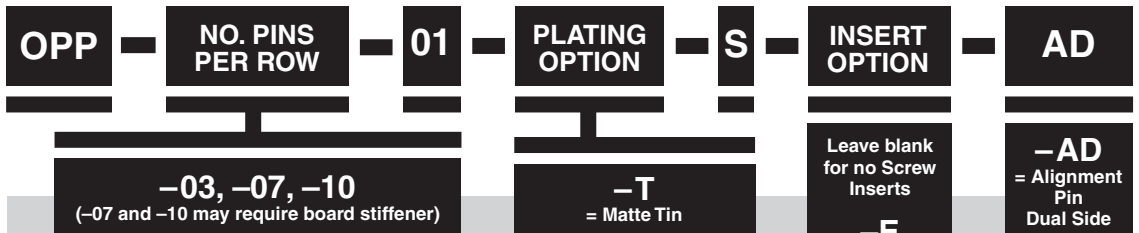

Leave blank for no Screw Inserts  
-E = #2-56 x 1/16" screw thread  
-M = 2,00mm x 0,40mm screw thread

-AD = Alignment Pin Dual Side

**Note:** Some sizes, styles and options are non-standard, non-returnable.

Due to technical progress, all designs, specifications and components are subject to change without notice.

[WWW.SAMTEC.COM](http://WWW.SAMTEC.COM)