

**MOS INTEGRATED CIRCUIT**  
 **$\mu$ PD44164085, 44164185, 44164365****18M-BIT DDRII SRAM SEPARATE I/O**  
**2-WORD BURST OPERATION****Description**

The  $\mu$ PD44164085 is a 2,097,152-word by 8-bit, the  $\mu$ PD44164185 is a 1,048,576-word by 18-bit and the  $\mu$ PD44164365 is a 524,288-word by 36-bit synchronous double data rate static RAM fabricated with advanced CMOS technology using full CMOS six-transistor memory cell.

The  $\mu$ PD44164085,  $\mu$ PD44164185 and  $\mu$ PD44164365 integrates unique synchronous peripheral circuitry and a burst counter. All input registers controlled by an input clock pair (K and /K) are latched on the positive edge of K and /K.

These products are suitable for application which require synchronous operation, high speed, low voltage, high density and wide bit configuration.

These products are packaged in 165-pin PLASTIC BGA.

**Features**

- $1.8 \pm 0.1$  V power supply and HSTL I/O
- DLL circuitry for wide output data valid window and future frequency scaling
- Separate independent read and write data ports
- DDR read or write operation initiated each cycle
- Pipelined double data rate operation
- Separate data input/output bus
- Two-tick burst for low DDR transaction size
- Two input clocks (K and /K) for precise DDR timing at clock rising edges only
- Two output clocks (C and /C) for precise flight time and clock skew matching-clock and data delivered together to receiving device
- Internally self-timed write control
- Clock-stop capability with  $\mu$ s restart
- User programmable impedance output
- Fast clock cycle time : 4.0 ns (250 MHz), 5.0 ns (200 MHz), 6.0 ns (167 MHz)
- Simple control logic for easy depth expansion
- JTAG boundary scan

The information in this document is subject to change without notice. Before using this document, please confirm that this is the latest version.  
Not all products and/or types are available in every country. Please check with an NEC Electronics sales representative for availability and additional information.

★ Ordering Information

| Part number           | Cycle Time ns | Clock Frequency MHz | Organization (word x bit) | Core Supply Voltage V | I/O Interface | Package                       |
|-----------------------|---------------|---------------------|---------------------------|-----------------------|---------------|-------------------------------|
| μPD44164085F5-E40-EQ1 | 4.0           | 250                 | 2 M x 8-bit               | 1.8 ± 0.1             | HSTL          | 165-pin PLASTIC BGA (13 x 15) |
| μPD44164085F5-E50-EQ1 | 5.0           | 200                 |                           |                       |               |                               |
| μPD44164085F5-E60-EQ1 | 6.0           | 167                 |                           |                       |               |                               |
| μPD44164185F5-E40-EQ1 | 4.0           | 250                 | 1 M x 18-bit              |                       |               |                               |
| μPD44164185F5-E50-EQ1 | 5.0           | 200                 |                           |                       |               |                               |
| μPD44164185F5-E60-EQ1 | 6.0           | 167                 |                           |                       |               |                               |
| μPD44164365F5-E50-EQ1 | 5.0           | 200                 | 512 K x 36-bit            |                       |               |                               |
| μPD44164365F5-E60-EQ1 | 6.0           | 167                 |                           |                       |               |                               |

Pin Configurations

/xxx indicates active low signal.

165-pin PLASTIC BGA (13 x 15)

(Top View)

[μPD44164085F5-EQ1]

|   | 1    | 2                | 3                | 4                | 5               | 6               | 7               | 8                | 9                | 10               | 11  |
|---|------|------------------|------------------|------------------|-----------------|-----------------|-----------------|------------------|------------------|------------------|-----|
| A | /CQ  | V <sub>SS</sub>  | A                | R, /W            | /NW1            | /K              | NC              | /LD              | A                | V <sub>SS</sub>  | CQ  |
| B | NC   | NC               | NC               | A                | NC              | K               | /NW0            | A                | NC               | NC               | Q3  |
| C | NC   | NC               | NC               | V <sub>SS</sub>  | A               | A               | A               | V <sub>SS</sub>  | NC               | NC               | D3  |
| D | NC   | D4               | NC               | V <sub>SS</sub>  | V <sub>SS</sub> | V <sub>SS</sub> | V <sub>SS</sub> | V <sub>SS</sub>  | NC               | NC               | NC  |
| E | NC   | NC               | Q4               | V <sub>DDQ</sub> | V <sub>SS</sub> | V <sub>SS</sub> | V <sub>SS</sub> | V <sub>DDQ</sub> | NC               | D2               | Q2  |
| F | NC   | NC               | NC               | V <sub>DDQ</sub> | V <sub>DD</sub> | V <sub>SS</sub> | V <sub>DD</sub> | V <sub>DDQ</sub> | NC               | NC               | NC  |
| G | NC   | D5               | Q5               | V <sub>DDQ</sub> | V <sub>DD</sub> | V <sub>SS</sub> | V <sub>DD</sub> | V <sub>DDQ</sub> | NC               | NC               | NC  |
| H | /DLL | V <sub>REF</sub> | V <sub>DDQ</sub> | V <sub>DDQ</sub> | V <sub>DD</sub> | V <sub>SS</sub> | V <sub>DD</sub> | V <sub>DDQ</sub> | V <sub>DDQ</sub> | V <sub>REF</sub> | ZQ  |
| J | NC   | NC               | NC               | V <sub>DDQ</sub> | V <sub>DD</sub> | V <sub>SS</sub> | V <sub>DD</sub> | V <sub>DDQ</sub> | NC               | Q1               | D1  |
| K | NC   | NC               | NC               | V <sub>DDQ</sub> | V <sub>DD</sub> | V <sub>SS</sub> | V <sub>DD</sub> | V <sub>DDQ</sub> | NC               | NC               | NC  |
| L | NC   | Q6               | D6               | V <sub>DDQ</sub> | V <sub>SS</sub> | V <sub>SS</sub> | V <sub>SS</sub> | V <sub>DDQ</sub> | NC               | NC               | Q0  |
| M | NC   | NC               | NC               | V <sub>SS</sub>  | V <sub>SS</sub> | V <sub>SS</sub> | V <sub>SS</sub> | V <sub>SS</sub>  | NC               | NC               | D0  |
| N | NC   | D7               | NC               | V <sub>SS</sub>  | A               | A               | A               | V <sub>SS</sub>  | NC               | NC               | NC  |
| P | NC   | NC               | Q7               | A                | A               | C               | A               | A                | NC               | NC               | NC  |
| R | TDO  | TCK              | A                | A                | A               | /C              | A               | A                | A                | TMS              | TDI |

- |            |                             |                  |                              |
|------------|-----------------------------|------------------|------------------------------|
| A          | : Address inputs            | TMS              | : IEEE 1149.1 Test input     |
| D0 to D7   | : Data inputs               | TDI              | : IEEE 1149.1 Test input     |
| Q0 to Q7   | : Data outputs              | TCK              | : IEEE 1149.1 Clock input    |
| /LD        | : Synchronous load          | TDO              | : IEEE 1149.1 Test output    |
| R, /W      | : Read Write input          | V <sub>REF</sub> | : HSTL input reference input |
| /NW0, /NW1 | : Nibble Write data select  | V <sub>DD</sub>  | : Power Supply               |
| K, /K      | : Input clock               | V <sub>DDQ</sub> | : Power Supply               |
| C, /C      | : Output clock              | V <sub>SS</sub>  | : Ground                     |
| CQ, /CQ    | : Echo clock                | NC               | : No connection              |
| ZQ         | : Output impedance matching |                  |                              |
| /DLL       | : DLL disable               |                  |                              |

**Remark** Refer to **Package Drawing** for the index mark.

165-pin PLASTIC BGA (13 x 15)  
 (Top View)  
 [μPD44164185F5-EQ1]

|   | 1    | 2                | 3                | 4                | 5               | 6               | 7               | 8                | 9                | 10               | 11  |
|---|------|------------------|------------------|------------------|-----------------|-----------------|-----------------|------------------|------------------|------------------|-----|
| A | /CQ  | V <sub>SS</sub>  | NC               | R, /W            | /BW1            | /K              | NC              | /LD              | A                | V <sub>SS</sub>  | CQ  |
| B | NC   | Q9               | D9               | A                | NC              | K               | /BW0            | A                | NC               | NC               | Q8  |
| C | NC   | NC               | D10              | V <sub>SS</sub>  | A               | A               | A               | V <sub>SS</sub>  | NC               | Q7               | D8  |
| D | NC   | D11              | Q10              | V <sub>SS</sub>  | V <sub>SS</sub> | V <sub>SS</sub> | V <sub>SS</sub> | V <sub>SS</sub>  | NC               | NC               | D7  |
| E | NC   | NC               | Q11              | V <sub>DDQ</sub> | V <sub>SS</sub> | V <sub>SS</sub> | V <sub>SS</sub> | V <sub>DDQ</sub> | NC               | D6               | Q6  |
| F | NC   | Q12              | D12              | V <sub>DDQ</sub> | V <sub>DD</sub> | V <sub>SS</sub> | V <sub>DD</sub> | V <sub>DDQ</sub> | NC               | NC               | Q5  |
| G | NC   | D13              | Q13              | V <sub>DDQ</sub> | V <sub>DD</sub> | V <sub>SS</sub> | V <sub>DD</sub> | V <sub>DDQ</sub> | NC               | NC               | D5  |
| H | /DLL | V <sub>REF</sub> | V <sub>DDQ</sub> | V <sub>DDQ</sub> | V <sub>DD</sub> | V <sub>SS</sub> | V <sub>DD</sub> | V <sub>DDQ</sub> | V <sub>DDQ</sub> | V <sub>REF</sub> | ZQ  |
| J | NC   | NC               | D14              | V <sub>DDQ</sub> | V <sub>DD</sub> | V <sub>SS</sub> | V <sub>DD</sub> | V <sub>DDQ</sub> | NC               | Q4               | D4  |
| K | NC   | NC               | Q14              | V <sub>DDQ</sub> | V <sub>DD</sub> | V <sub>SS</sub> | V <sub>DD</sub> | V <sub>DDQ</sub> | NC               | D3               | Q3  |
| L | NC   | Q15              | D15              | V <sub>DDQ</sub> | V <sub>SS</sub> | V <sub>SS</sub> | V <sub>SS</sub> | V <sub>DDQ</sub> | NC               | NC               | Q2  |
| M | NC   | NC               | D16              | V <sub>SS</sub>  | V <sub>SS</sub> | V <sub>SS</sub> | V <sub>SS</sub> | V <sub>SS</sub>  | NC               | Q1               | D2  |
| N | NC   | D17              | Q16              | V <sub>SS</sub>  | A               | A               | A               | V <sub>SS</sub>  | NC               | NC               | D1  |
| P | NC   | NC               | Q17              | A                | A               | C               | A               | A                | NC               | D0               | Q0  |
| R | TDO  | TCK              | A                | A                | A               | /C              | A               | A                | A                | TMS              | TDI |

- |            |                             |                  |                              |
|------------|-----------------------------|------------------|------------------------------|
| A          | : Address inputs            | TMS              | : IEEE 1149.1 Test input     |
| D0 to D17  | : Data inputs               | TDI              | : IEEE 1149.1 Test input     |
| Q0 to Q17  | : Data outputs              | TCK              | : IEEE 1149.1 Clock input    |
| /LD        | : Synchronous load          | TDO              | : IEEE 1149.1 Test output    |
| R, /W      | : Read Write input          | V <sub>REF</sub> | : HSTL input reference input |
| /BW0, /BW1 | : Byte Write data select    | V <sub>DD</sub>  | : Power Supply               |
| K, /K      | : Input clock               | V <sub>DDQ</sub> | : Power Supply               |
| C, /C      | : Output clock              | V <sub>SS</sub>  | : Ground                     |
| CQ, /CQ    | : Echo clock                | NC               | : No connection              |
| ZQ         | : Output impedance matching |                  |                              |
| /DLL       | : DLL disable               |                  |                              |

**Remark** Refer to **Package Drawing** for the index mark.

165-pin PLASTIC BGA (13 x 15)

(Top View)

[μPD44164365F5-EQ1]

|   | 1    | 2                | 3                | 4                | 5               | 6               | 7               | 8                | 9                | 10               | 11  |
|---|------|------------------|------------------|------------------|-----------------|-----------------|-----------------|------------------|------------------|------------------|-----|
| A | /CQ  | V <sub>SS</sub>  | NC               | R, /W            | /BW2            | /K              | /BW1            | /LD              | NC               | V <sub>SS</sub>  | CQ  |
| B | Q27  | Q18              | D18              | A                | /BW3            | K               | /BW0            | A                | D17              | Q17              | Q8  |
| C | D27  | Q28              | D19              | V <sub>SS</sub>  | A               | A               | A               | V <sub>SS</sub>  | D16              | Q7               | D8  |
| D | D28  | D20              | Q19              | V <sub>SS</sub>  | V <sub>SS</sub> | V <sub>SS</sub> | V <sub>SS</sub> | V <sub>SS</sub>  | Q16              | D15              | D7  |
| E | Q29  | D29              | Q20              | V <sub>DDQ</sub> | V <sub>SS</sub> | V <sub>SS</sub> | V <sub>SS</sub> | V <sub>DDQ</sub> | Q15              | D6               | Q6  |
| F | Q30  | Q21              | D21              | V <sub>DDQ</sub> | V <sub>DD</sub> | V <sub>SS</sub> | V <sub>DD</sub> | V <sub>DDQ</sub> | D14              | Q14              | Q5  |
| G | D30  | D22              | Q22              | V <sub>DDQ</sub> | V <sub>DD</sub> | V <sub>SS</sub> | V <sub>DD</sub> | V <sub>DDQ</sub> | Q13              | D13              | D5  |
| H | /DLL | V <sub>REF</sub> | V <sub>DDQ</sub> | V <sub>DDQ</sub> | V <sub>DD</sub> | V <sub>SS</sub> | V <sub>DD</sub> | V <sub>DDQ</sub> | V <sub>DDQ</sub> | V <sub>REF</sub> | ZQ  |
| J | D31  | Q31              | D23              | V <sub>DDQ</sub> | V <sub>DD</sub> | V <sub>SS</sub> | V <sub>DD</sub> | V <sub>DDQ</sub> | D12              | Q4               | D4  |
| K | Q32  | D32              | Q23              | V <sub>DDQ</sub> | V <sub>DD</sub> | V <sub>SS</sub> | V <sub>DD</sub> | V <sub>DDQ</sub> | Q12              | D3               | Q3  |
| L | Q33  | Q24              | D24              | V <sub>DDQ</sub> | V <sub>SS</sub> | V <sub>SS</sub> | V <sub>SS</sub> | V <sub>DDQ</sub> | D11              | Q11              | Q2  |
| M | D33  | Q34              | D25              | V <sub>SS</sub>  | V <sub>SS</sub> | V <sub>SS</sub> | V <sub>SS</sub> | V <sub>SS</sub>  | D10              | Q1               | D2  |
| N | D34  | D26              | Q25              | V <sub>SS</sub>  | A               | A               | A               | V <sub>SS</sub>  | Q10              | D9               | D1  |
| P | Q35  | D35              | Q26              | A                | A               | C               | A               | A                | Q9               | D0               | Q0  |
| R | TDO  | TCK              | A                | A                | A               | /C              | A               | A                | A                | TMS              | TDI |

- |              |                             |                  |                              |
|--------------|-----------------------------|------------------|------------------------------|
| A            | : Address inputs            | TMS              | : IEEE 1149.1 Test input     |
| D0 to D35    | : Data inputs               | TDI              | : IEEE 1149.1 Test input     |
| Q0 to Q35    | : Data outputs              | TCK              | : IEEE 1149.1 Clock input    |
| /LD          | : Synchronous load          | TDO              | : IEEE 1149.1 Test output    |
| R, /W        | : Read Write input          | V <sub>REF</sub> | : HSTL input reference input |
| /BW0 to /BW3 | : Byte Write data select    | V <sub>DD</sub>  | : Power Supply               |
| K, /K        | : Input clock               | V <sub>DDQ</sub> | : Power Supply               |
| C, /C        | : Output clock              | V <sub>SS</sub>  | : Ground                     |
| CQ, /CQ      | : Echo clock                | NC               | : No connection              |
| ZQ           | : Output impedance matching |                  |                              |
| /DLL         | : DLL disable               |                  |                              |

**Remark** Refer to **Package Drawing** for the index mark.

Pin Identification

| Symbol       | Description   |
|--------------|---|
| A            | Synchronous Address Inputs: These inputs are registered and must meet the setup and hold times around the rising edge of K. Balls 9A, 3A, 10A, and 2A are reserved for the next higher-order address inputs on future devices. All transactions operate on a burst of two words (one clock period of bus activity). These inputs are ignored when device is deselected.   |
| D0 to Dxx    | Synchronous Data Inputs: Input data must meet setup and hold times around the rising edges of K and /K during WRITE operations. See Pin Configurations for ball site location of individual signals.<br>x8 device uses D0 to D7.<br>x18 device uses D0 to D17.<br>x36 device uses D0 to D35.  |
| Q0 to Qxx    | Synchronous Data Outputs: Output data is synchronized to the respective C and /C or to K and /K rising edges if C and /C are tied HIGH. This bus operates in response to /R commands. See Pin Configurations for ball site location of individual signals.<br>x8 device uses Q0 to Q7.<br>x18 device uses Q0 to Q17.<br>x36 device uses Q0 to Q35.  |
| /LD          | Synchronous Load: This input is brought LOW when a bus cycle sequence is to be defined. This definition includes address and read/write direction. All transactions operate on a burst of 2 data (one clock period of bus activity).  |
| R, /W        | Synchronous Read/Write Input: When /LD is LOW, this input designates the access type (READ when R, /W is HIGH, WRITE when R, /W is LOW) for the loaded address. R, /W must meet the setup and hold times around the rising edge of K.   |
| /BWx<br>/NWx | Synchronous Byte Writes (Nibble Writes on x8): When LOW these inputs cause their respective byte or nibble to be registered and written during WRITE cycles. These signals must meet setup and hold times around the rising edges of K and /K for each of the two rising edges comprising the WRITE cycle. See Pin Configurations for signal to data relationships.   |
| K, /K        | Input Clock: This input clock pair registers address and control inputs on the rising edge of K, and registers data on the rising edge of K and the rising edge of /K. /K is ideally 180 degrees out of phase with K. All synchronous inputs must meet setup and hold times around the clock rising edges.  |
| C, /C        | Output Clock: This clock pair provides a user controlled means of tuning device output data. The rising edge of /C is used as the output timing reference for first output data. The rising edge of C is used as the output reference for second output data. Ideally, /C is 180 degrees out of phase with C. C and /C may be tied HIGH to force the use of K and /K as the output reference clocks instead of having to provide C and /C clocks. If tied HIGH, C and /C must remain HIGH and not be toggled during device operation. |
| CQ, /CQ      | Synchronous Echo Clock Outputs. The rising edges of these outputs are tightly matched to the synchronous data outputs and can be used as a data valid indication. These signals run freely and do not stop when Q tristates.  |
| ZQ           | Output Impedance Matching Input: This input is used to tune the device outputs to the system data bus impedance. DQ and CQ output impedance are set to $0.2 \times RQ$ , where RQ is a resistor from this bump to ground. This pin cannot be connected directly to GND or left unconnected. Also, in this product, there is no function to minimize the output impedance by connecting ZQ directly to V <sub>DDQ</sub> .  |
| /DLL         | DLL Disable: When LOW, this input causes the DLL to be bypassed for stable low frequency operation.   |
| TMS<br>TDI   | IEEE 1149.1 Test Inputs: 1.8V I/O levels. These balls may be left Not Connected if the JTAG function is not used in the circuit.  |
| TCK          | IEEE 1149.1 Clock Input: 1.8V I/O levels. This pin must be tied to V <sub>SS</sub> if the JTAG function is not used in the circuit.   |
| TDO          | IEEE 1149.1 Test Output: 1.8V I/O level.  |
| VREF         | HSTL Input Reference Voltage: Nominally V <sub>DDQ</sub> /2. Provides a reference voltage for the input buffers.  |
| VDD          | Power Supply: 1.8V nominal. See DC Characteristics and Operating Conditions for range.  |
| VDDQ         | Power Supply: Isolated Output Buffer Supply. Nominally 1.5V. 1.8V is also permissible. See DC Characteristics and Operating Conditions for range.   |
| VSS          | Power Supply: Ground  |
| NC           | No Connect: These signals are internally connected and appear in the JTAG scan chain as the logic level applied to the ball sites. These signals may be connected to ground to improve package heat dissipation.  |

Block Diagrams

[μPD44164085]

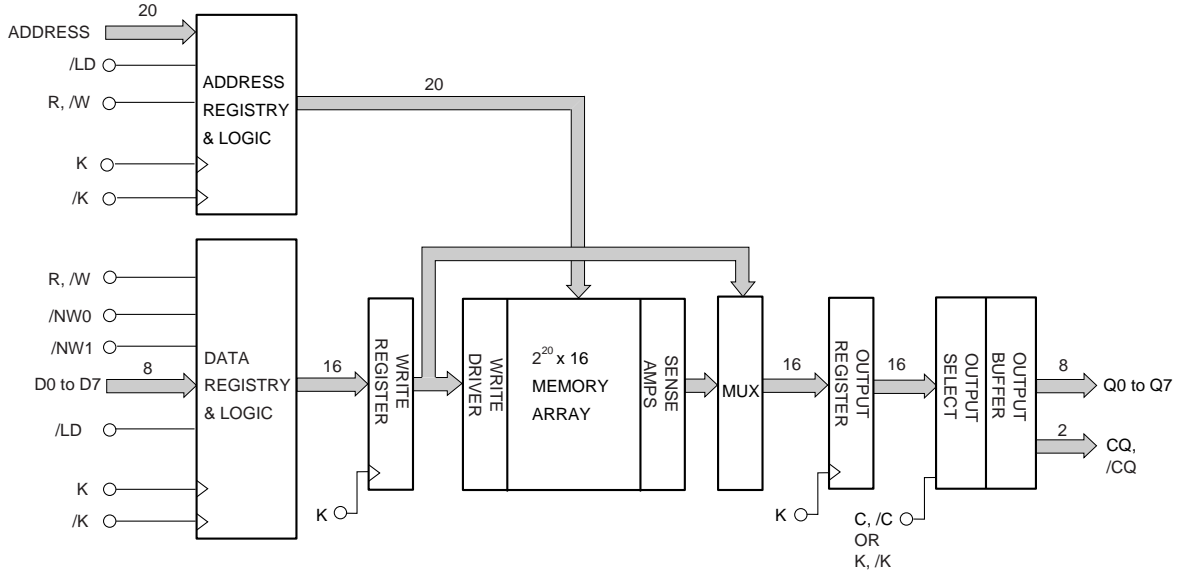

[μPD44164185]

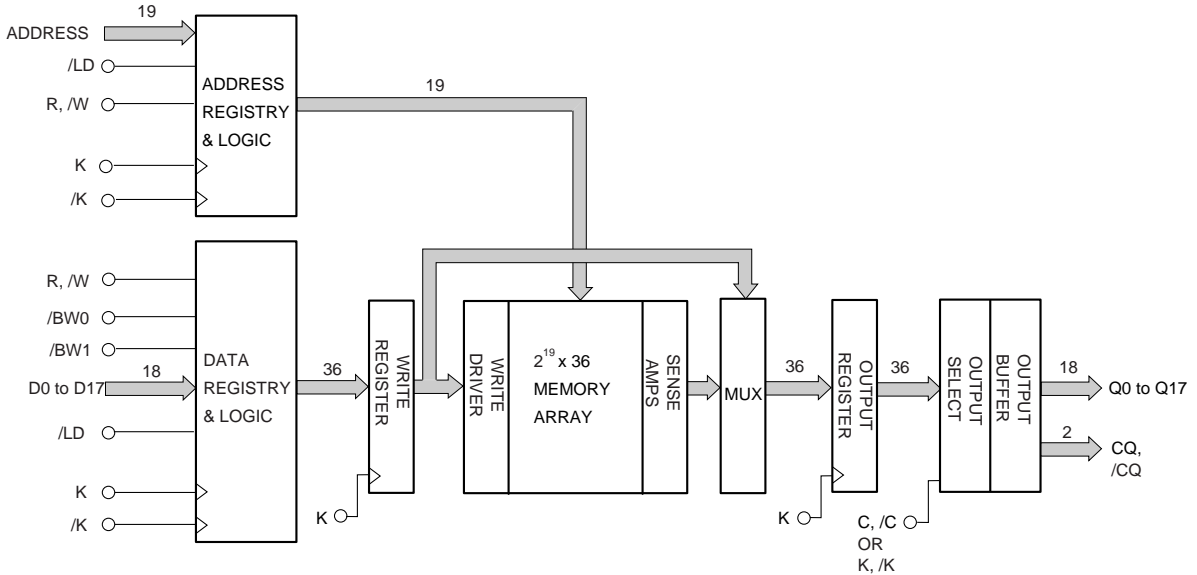

[μPD44164365]

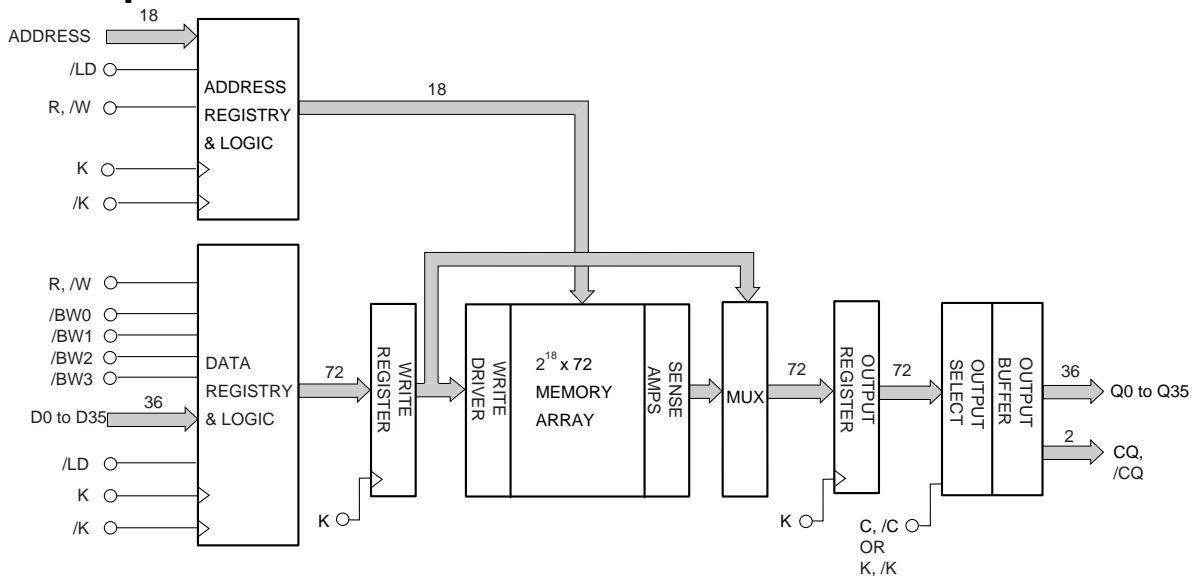

Truth Table

| Operation   | /LD | R, /W | CLK     | D or Q         |           |           |
|---|-----|-------|---------|----------------|-----------|-----------|
| WRITE cycle<br>Load address, input write data on two consecutive K and /K rising edge | L   | L     | L → H   | Data in        |           |           |
|   |     |       |         | Input data     | D(A+0)    | D(A+1)    |
|   |     |       |         | Input clock    | K(t+1) ↑  | /K(t+1) ↑ |
| READ cycle<br>Load address, read data on two consecutive C and /C rising edge         | L   | H     | L → H   | Data out       |           |           |
|   |     |       |         | Output data    | Q(A+0)    | Q(A+1)    |
|   |     |       |         | Output clock   | /C(t+1) ↑ | C(t+2) ↑  |
| NOP (No operation)  | H   | X     | L → H   | High-Z         |           |           |
| STANDBY(Clock stopped)  | X   | X     | Stopped | Previous state |           |           |

- Remarks**
1. H : High level, L : Low level, x : don't care, ↑ : rising edge.
  2. Data inputs are registered at K and /K rising edges. Data outputs are delivered at C and /C rising edges except if C and /C are HIGH then Data outputs are delivered at K and /K rising edges.
  3. All control inputs in the truth table must meet setup/hold times around the rising edge (LOW to HIGH) of K. All control inputs are registered during the rising edge of K.
  4. This device contains circuitry that will ensure the outputs will be in high impedance during power-up.
  5. Refer to state diagram and timing diagrams for clarification.
  6. It is recommended that K = /K = C = /C when clock is stopped. This is not essential but permits most rapid restart by overcoming transmission line charging symmetrically.



Byte Write Operation

[μPD44164085]

| Operation      | K     | /K    | /NW0 | /NW1 |
|----------------|-------|-------|------|------|
| Write D0 to D7 | L → H | –     | 0    | 0    |
|                | –     | L → H | 0    | 0    |
| Write D0 to D3 | L → H | –     | 0    | 1    |
|                | –     | L → H | 0    | 1    |
| Write D4 to D7 | L → H | –     | 1    | 0    |
|                | –     | L → H | 1    | 0    |
| Write nothing  | L → H | –     | 1    | 1    |
|                | –     | L → H | 1    | 1    |

**Remark** H : High level, L : Low level, → : rising edge.

[μPD44164185]

| Operation       | K     | /K    | /BW0 | /BW1 |
|-----------------|-------|-------|------|------|
| Write D0 to D17 | L → H | –     | 0    | 0    |
|                 | –     | L → H | 0    | 0    |
| Write D0 to D8  | L → H | –     | 0    | 1    |
|                 | –     | L → H | 0    | 1    |
| Write D9 to D17 | L → H | –     | 1    | 0    |
|                 | –     | L → H | 1    | 0    |
| Write nothing   | L → H | –     | 1    | 1    |
|                 | –     | L → H | 1    | 1    |

**Remark** H : High level, L : Low level, → : rising edge.

[μPD44164365]

| Operation        | K     | /K    | /BW0 | /BW1 | /BW2 | /BW3 |
|------------------|-------|-------|------|------|------|------|
| Write D0 to D35  | L → H | –     | 0    | 0    | 0    | 0    |
|                  | –     | L → H | 0    | 0    | 0    | 0    |
| Write D0 to D8   | L → H | –     | 0    | 1    | 1    | 1    |
|                  | –     | L → H | 0    | 1    | 1    | 1    |
| Write D9 to D17  | L → H | –     | 1    | 0    | 1    | 1    |
|                  | –     | L → H | 1    | 0    | 1    | 1    |
| Write D18 to D26 | L → H | –     | 1    | 1    | 0    | 1    |
|                  | –     | L → H | 1    | 1    | 0    | 1    |
| Write D27 to D35 | L → H | –     | 1    | 1    | 1    | 0    |
|                  | –     | L → H | 1    | 1    | 1    | 0    |
| Write nothing    | L → H | –     | 1    | 1    | 1    | 1    |
|                  | –     | L → H | 1    | 1    | 1    | 1    |

**Remark** H : High level, L : Low level, → : rising edge.

Bus Cycle State Diagram

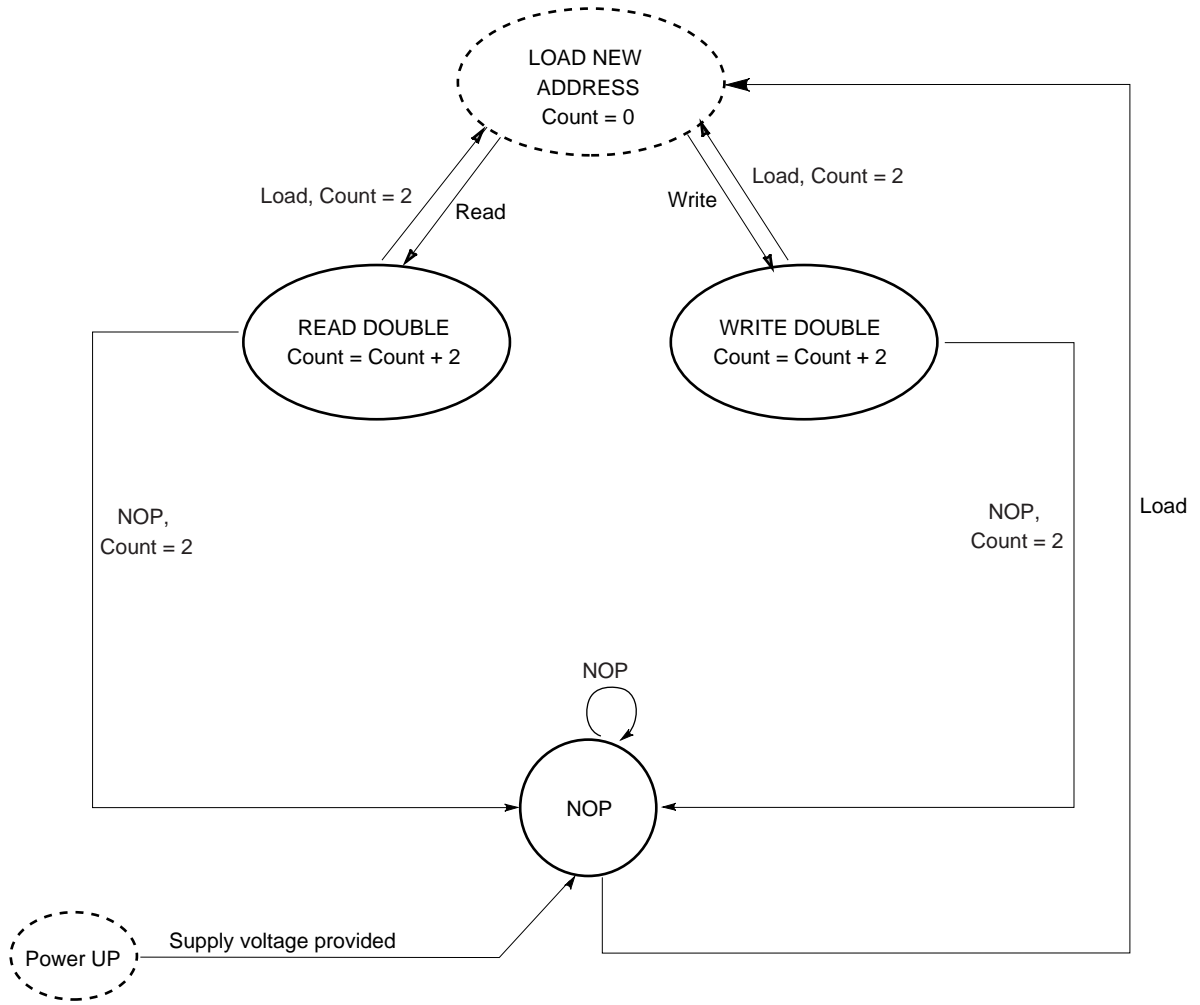

**Remark** State machine control timing sequence is controlled by K.

**Electrical Specifications**

**Absolute Maximum Ratings**

| Parameter                     | Symbol           | Conditions | MIN. | TYP. | MAX.                                | Unit |
|-------------------------------|------------------|------------|------|------|-------------------------------------|------|
| Supply voltage                | V <sub>DD</sub>  |            | -0.5 |      | +2.9                                | V    |
| Output supply voltage         | V <sub>DDQ</sub> |            | -0.5 |      | V <sub>DD</sub>                     | V    |
| Input voltage                 | V <sub>IN</sub>  |            | -0.5 |      | V <sub>DD</sub> + 0.5 (2.9 V MAX.)  | V    |
| Input / Output voltage        | V <sub>I/O</sub> |            | -0.5 |      | V <sub>DDQ</sub> + 0.5 (2.9 V MAX.) | V    |
| Operating ambient temperature | T <sub>A</sub>   |            | 0    |      | 70                                  | °C   |
| Storage temperature           | T <sub>stg</sub> |            | -55  |      | +125                                | °C   |

**Caution** Exposing the device to stress above those listed in Absolute Maximum Ratings could cause permanent damage. The device is not meant to be operated under conditions outside the limits described in the operational section of this specification. Exposure to Absolute Maximum Rating conditions for extended periods may affect device reliability.

**Recommended DC Operating Conditions (T<sub>A</sub> = 0 to 70 °C)**

| Parameter                | Symbol               | Conditions | MIN.                   | TYP. | MAX.                   | Unit | Note |
|--------------------------|----------------------|------------|------------------------|------|------------------------|------|------|
| Supply voltage           | V <sub>DD</sub>      |            | 1.7                    |      | 1.9                    | V    |      |
| Output supply voltage    | V <sub>DDQ</sub>     |            | 1.4                    |      | V <sub>DD</sub>        | V    | 1    |
| High level input voltage | V <sub>IH</sub> (DC) |            | V <sub>REF</sub> + 0.1 |      | V <sub>DDQ</sub> + 0.3 | V    | 1, 2 |
| Low level input voltage  | V <sub>IL</sub> (DC) |            | -0.3                   |      | V <sub>REF</sub> - 0.1 | V    | 1, 2 |
| Clock input voltage      | V <sub>IN</sub>      |            | -0.3                   |      | V <sub>DDQ</sub> + 0.3 | V    | 1, 2 |
| Reference voltage        | V <sub>REF</sub>     |            | 0.68                   |      | 0.95                   | V    |      |

- Notes**
1. During normal operation, V<sub>DDQ</sub> must not exceed V<sub>DD</sub>.
  2. Power-up: V<sub>IH</sub> ≤ V<sub>DDQ</sub> + 0.3 V and V<sub>DD</sub> ≤ 1.7 V and V<sub>DDQ</sub> ≤ 1.4 V for t ≤ 200 ms

**Recommended AC Operating Conditions (T<sub>A</sub> = 0 to 70 °C)**

| Parameter                | Symbol               | Conditions | MIN.                   | TYP. | MAX.                   | Unit | Note |
|--------------------------|----------------------|------------|------------------------|------|------------------------|------|------|
| High level input voltage | V <sub>IH</sub> (AC) |            | V <sub>REF</sub> + 0.2 |      | -                      | V    | 1    |
| Low level input voltage  | V <sub>IL</sub> (AC) |            | -                      |      | V <sub>REF</sub> - 0.2 | V    | 1    |

- Note**
1. Overshoot: V<sub>IH</sub> (AC) ≤ V<sub>DD</sub> + 0.7 V for t ≤ TKHKH/2  
 Undershoot: V<sub>IL</sub> (AC) ≥ - 0.5 V for t ≤ TKHKH/2  
 Control input signals may not have pulse widths less than TKHKL (MIN.) or operate at cycle rates less than TKHKH (MIN.).

DC Characteristics (T<sub>A</sub> = 0 to 70°C, V<sub>DD</sub> = 1.8 ± 0.1 V)

| Parameter  | Symbol               | Test condition  | MIN.                       | TYP. | MAX.                       |     | Unit | Note |
|--|----------------------|---|----------------------------|------|----------------------------|-----|------|------|
|  |                      |   |                            |      | x8, x18                    | x36 |      |      |
| Input leakage current                            | I <sub>LI</sub>      |   | -2                         | -    | +2                         |     | μA   |      |
| I/O leakage current                              | I <sub>LO</sub>      |   | -2                         | -    | +2                         |     | μA   |      |
| ★ Operating supply current<br>(Read Write cycle) | I <sub>DD</sub>      | V <sub>IN</sub> ≤ V <sub>IL</sub> or V <sub>IN</sub> ≥ V <sub>IH</sub> ,<br>I <sub>I/O</sub> = 0 mA<br>Cycle = MAX. | -E40                       |      | 650                        | -   | mA   |      |
| -E50   |                      |   |                            | 550  | 650                        |     |      |      |
| -E60   |                      |   |                            | 480  | 570                        |     |      |      |
| ★ Standby supply current<br>(NOP)                | I <sub>SB1</sub>     | V <sub>IN</sub> ≤ V <sub>IL</sub> or V <sub>IN</sub> ≥ V <sub>IH</sub> ,<br>I <sub>I/O</sub> = 0 mA<br>Cycle = MAX. | -E40                       |      | 320                        | -   | mA   |      |
| -E50   |                      |   |                            | 270  |                            |     |      |      |
| -E60   |                      |   |                            | 250  |                            |     |      |      |
| High level output voltage                        | V <sub>OH(Low)</sub> | I <sub>OH</sub>   ≤ 0.1 mA  | V <sub>DDQ</sub> - 0.2     | -    | V <sub>DDQ</sub>           |     | V    | 3, 4 |
|  | V <sub>OH</sub>      | Note1   | V <sub>DDQ</sub> /2 - 0.12 | -    | V <sub>DDQ</sub> /2 + 0.12 |     | V    | 3, 4 |
| Low level output voltage                         | V <sub>OL(Low)</sub> | I <sub>OL</sub> ≤ 0.1 mA  | V <sub>SS</sub>            | -    | 0.2                        |     | V    | 3, 4 |
|  | V <sub>OL</sub>      | Note2   | V <sub>DDQ</sub> /2 - 0.12 | -    | V <sub>DDQ</sub> /2 + 0.12 |     | V    | 3, 4 |

- Notes**
1. Outputs are impedance-controlled. |I<sub>OH</sub>| = (V<sub>DDQ</sub>/2)/(R<sub>Q</sub>/5) for values of 175 Ω ≤ R<sub>Q</sub> ≤ 350 Ω.
  2. Outputs are impedance-controlled. I<sub>OL</sub> = (V<sub>DDQ</sub>/2)/(R<sub>Q</sub>/5) for values of 175 Ω ≤ R<sub>Q</sub> ≤ 350 Ω.
  3. AC load current is higher than the shown DC values.
  4. HSTL outputs meet JEDEC HSTL Class I and Class II standards.

Capacitance (T<sub>A</sub> = 25 °C, f = 1MHz)

| Parameter                  | Symbol           | Test conditions        | MIN. | TYP. | MAX. | Unit |
|----------------------------|------------------|------------------------|------|------|------|------|
| Input capacitance          | C <sub>IN</sub>  | V <sub>IN</sub> = 0 V  |      | 4    | 5    | pF   |
| Input / Output capacitance | C <sub>I/O</sub> | V <sub>I/O</sub> = 0 V |      | 6    | 7    | pF   |
| Clock Input capacitance    | C <sub>clk</sub> | V <sub>clk</sub> = 0 V |      | 5    | 6    | pF   |

**Remark** These parameters are periodically sampled and not 100% tested.

AC Characteristics ( $T_A = 0$  to  $70$  °C,  $V_{DD} = 1.8 \pm 0.1$  V)

AC Test Conditions

Input waveform (Rise / Fall time  $\leq 0.3$  ns)

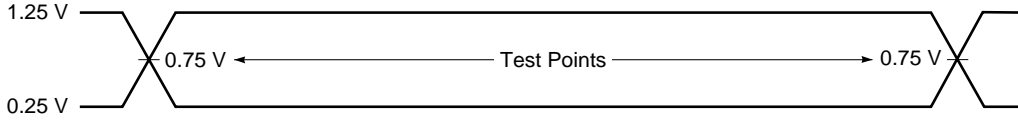

Output waveform

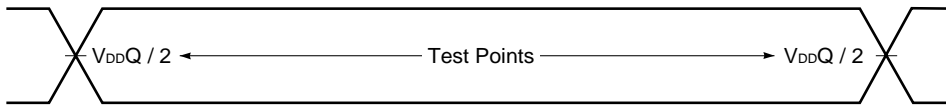

Output load condition

Figure 1. External load at test

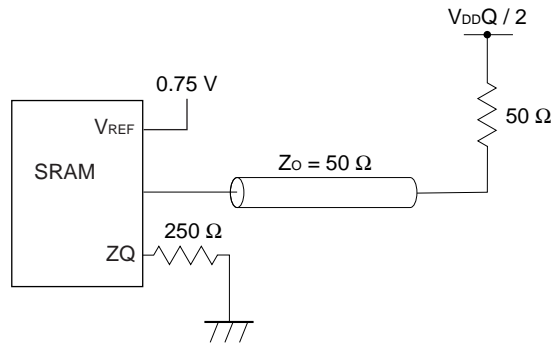

Read and Write Cycle

| Parameter  | Symbol    | -E40<br>(250 MHz) |      | -E50<br>(200 MHz) |      | -E60<br>(167 MHz) |      | Unit  | Note |  |
|--|-----------|-------------------|------|-------------------|------|-------------------|------|-------|------|--|
|  |           | MIN.              | MAX. | MIN.              | MAX. | MIN.              | MAX. |       |      |  |
| <b>Clock</b>   |           |                   |      |                   |      |                   |      |       |      |  |
| Average Clock cycle time (K, /K, C, /C)  | TKHKH     | 4.0               | 8.4  | 5.0               | 8.4  | 6.0               | 8.4  | ns    | 1    |  |
| Clock phase jitter (K, /K, C, /C)  | TKC var   | –                 | 0.2  | –                 | 0.2  | –                 | 0.2  | ns    | 2    |  |
| Clock HIGH time (K, /K, C, /C)   | TKHKL     | 1.6               | –    | 2.0               | –    | 2.4               | –    | ns    |      |  |
| Clock LOW time (K, /K, C, /C)  | TKLKH     | 1.6               | –    | 2.0               | –    | 2.4               | –    | ns    |      |  |
| Clock to /clock (K→/K., C→/C.)   | TKH /KH   | 1.8               | –    | 2.2               | –    | 2.7               | –    | ns    |      |  |
| Clock to /clock (/K→K., /C→C.)   | T /KHKH   | 1.8               | –    | 2.2               | –    | 2.7               | –    | ns    |      |  |
| Clock to data clock<br>(K→C., /K→/C.)  | TKHCH     | 200 to 250 MHz    | 0    | 1.8               | –    | –                 | –    | –     | ns   |  |
|  |           | 167 to 200 MHz    | 0    | 2.3               | 0    | 2.3               | –    | –     |      |  |
|  |           | 133 to 167 MHz    | 0    | 2.8               | 0    | 2.8               | 0    | 2.8   |      |  |
|  |           | < 133 MHz         | 0    | 3.55              | 0    | 3.55              | 0    | 3.55  |      |  |
| DLL lock time (K, C)   | TKC lock  | 1,024             | –    | 1,024             | –    | 1,024             | –    | Cycle | 3    |  |
| K static to DLL reset  | TKC reset | 30                | –    | 30                | –    | 30                | –    | ns    |      |  |
| <b>Output Times</b>  |           |                   |      |                   |      |                   |      |       |      |  |
| C, /C HIGH to output valid   | TCHQV     | –                 | 0.45 | –                 | 0.45 | –                 | 0.5  | ns    |      |  |
| C, /C HIGH to output hold  | TCHQX     | –0.45             | –    | –0.45             | –    | –0.5              | –    | ns    |      |  |
| C, /C HIGH to echo clock valid   | TCHCQV    | –                 | 0.45 | –                 | 0.45 | –                 | 0.5  | ns    |      |  |
| C, /C HIGH to echo clock hold  | TCHCQX    | –0.45             | –    | –0.45             | –    | –0.5              | –    | ns    |      |  |
| CQ, /CQ HIGH to output valid   | TCQHQV    | –                 | 0.3  | –                 | 0.35 | –                 | 0.4  | ns    | 4    |  |
| CQ, /CQ HIGH to output hold  | TCQHQX    | –0.3              | –    | –0.35             | –    | –0.4              | –    | ns    | 4    |  |
| C HIGH to output High-Z  | TCHQZ     | –                 | 0.45 | –                 | 0.45 | –                 | 0.5  | ns    |      |  |
| C HIGH to output Low-Z   | TCHQX1    | –0.45             | –    | –0.45             | –    | –0.5              | –    | ns    |      |  |
| <b>Setup Times</b>   |           |                   |      |                   |      |                   |      |       |      |  |
| Address valid to K rising edge   | TAVKH     | 0.5               | –    | 0.6               | –    | 0.7               | –    | ns    | 5    |  |
| Synchronous load input (/LD),<br>read write input (R, /W) valid to<br>K rising edge    | TIVKH     | 0.5               | –    | 0.6               | –    | 0.7               | –    | ns    | 5    |  |
| Data inputs and write data select<br>inputs (/BWx, /NWx) valid to<br>K, /K rising edge | TDVKH     | 0.35              | –    | 0.4               | –    | 0.5               | –    | ns    | 5    |  |
| <b>Hold Times</b>  |           |                   |      |                   |      |                   |      |       |      |  |
| K rising edge to address hold  | TKHAX     | 0.5               | –    | 0.6               | –    | 0.7               | –    | ns    | 5    |  |
| K rising edge to<br>synchronous load input (/LD),<br>read write input (R, /W) hold     | TKHIX     | 0.5               | –    | 0.6               | –    | 0.7               | –    | ns    | 5    |  |
| K, /K rising edge to data inputs and<br>write data select inputs (/BWx, /NWx)<br>hold  | TKHDX     | 0.35              | –    | 0.4               | –    | 0.5               | –    | ns    | 5    |  |

- Notes**
1. The device will operate at clock frequencies slower than TKHKH(MAX.).
  2. Clock phase jitter is the variance from clock rising edge to the next expected clock rising edge.
  3.  $V_{DD}$  slew rate must be less than 0.1 V DC per 50 ns for DLL lock retention.  
DLL lock time begins once  $V_{DD}$  and input clock are stable.  
It is recommended that the device is kept inactive during these cycles.
  4. Echo clock is very tightly controlled to data valid / data hold. By design, there is a  $\pm 0.1$  ns variation from echo clock to data. The data sheet parameters reflect tester guardbands and test setup variations.
  5. This is a synchronous device. All addresses, data and control lines must meet the specified setup and hold times for all latching clock edges.

- Remarks**
1. This parameter is sampled.
  2. Test conditions as specified with the output loading as shown in AC Test Conditions unless otherwise noted.
  3. Control input signals may not be operated with pulse widths less than TKHKL (MIN.).
  4. If C, /C are tied HIGH, K, /K become the references for C, /C timing parameters.
  5.  $V_{DDQ}$  is 1.5 V DC.

Read and Write Timing

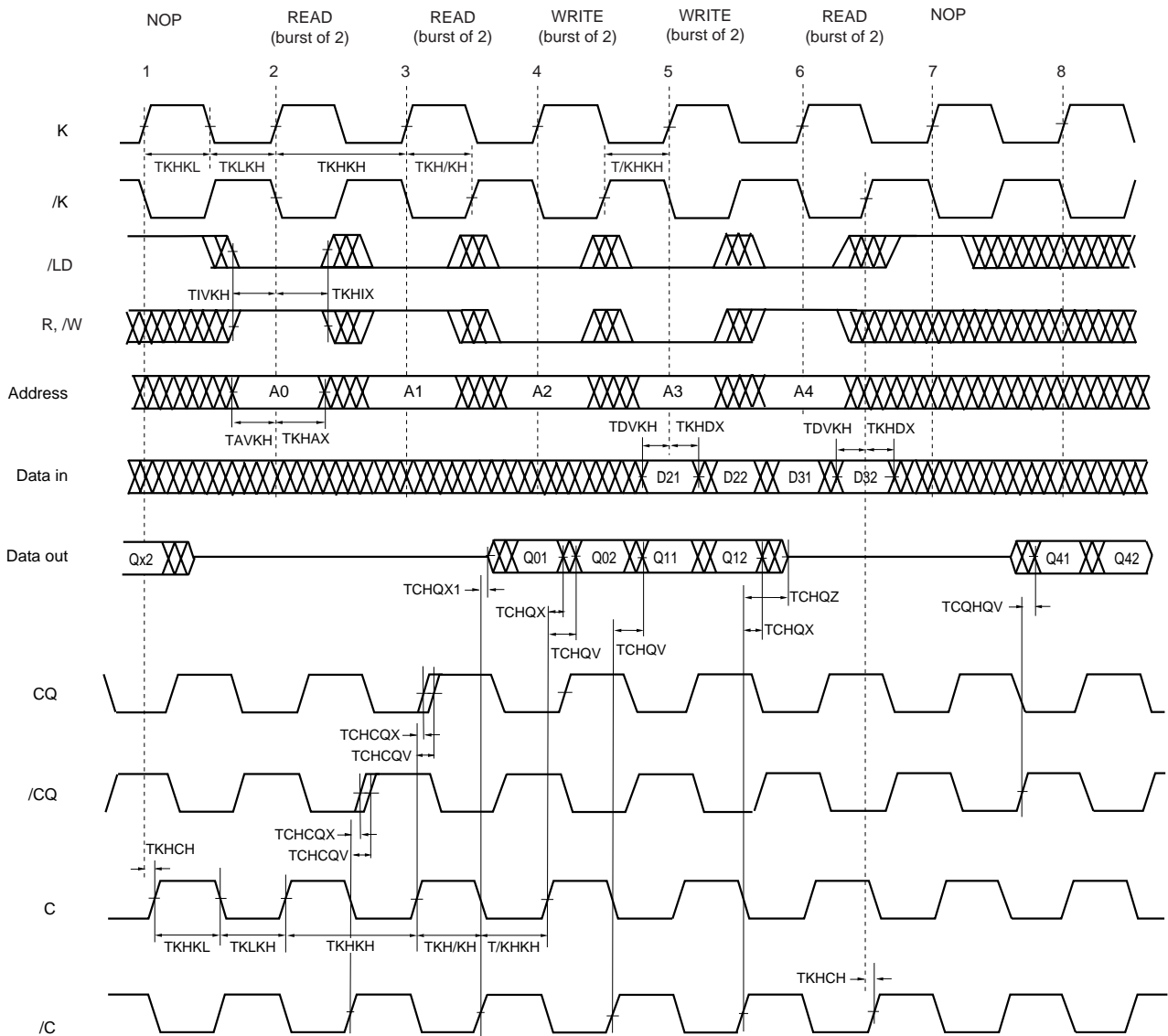

- Remarks**
1. Q01 refers to output from address A0+0.  
Q02 refers to output from the next internal burst address following A0, i.e., A0+1.
  2. Outputs are disable (high impedance) one clock cycle after a NOP.
  3. In this example, if address A3=A4, data Q41=D31, Q42=D32.  
Write data is forwarded immediately as read results.



**JTAG Specification**

These products support a limited set of JTAG functions as in IEEE standard 1149.1.

**Test Access Port (TAP) Pins**

| Pin name | Pin assignments | Description   |
|----------|-----------------|---|
| TCK      | 2R              | Test Clock Input. All input are captured on the rising edge of TCK and all outputs propagate from the falling edge of TCK.  |
| TMS      | 10R             | Test Mode Select. This is the command input for the TAP controller state machine.   |
| TDI      | 11R             | Test Data Input. This is the input side of the serial registers placed between TDI and TDO. The register placed between TDI and TDO is determined by the state of the TAP controller state machine and the instruction that is currently loaded in the TAP instruction. |
| TDO      | 1R              | Test Data Output. Output changes in response to the falling edge of TCK. This is the output side of the serial registers placed between TDI and TDO.  |

**Remark** The device does not have TRST (TAP reset). The Test-Logic Reset state is entered while TMS is held high for five rising edges of TCK. The TAP controller state is also reset on the SRAM POWER-UP.

**JTAG DC Characteristics (T<sub>A</sub> = 0 to 70°C, V<sub>DD</sub> = 1.8 ± 0.1 V, unless otherwise noted)**

| Parameter                  | Symbol           | Conditions   | MIN. | TYP. | MAX.                  | Unit | Note |
|----------------------------|------------------|--|------|------|-----------------------|------|------|
| JTAG Input leakage current | I <sub>LI</sub>  | 0 V ≤ V <sub>IN</sub> ≤ V <sub>DD</sub>                        | -5.0 | -    | +5.0                  | μA   |      |
| JTAG I/O leakage current   | I <sub>LO</sub>  | 0 V ≤ V <sub>IN</sub> ≤ V <sub>DDQ</sub> ,<br>Outputs disabled | -5.0 | -    | +5.0                  | μA   |      |
| JTAG input high voltage    | V <sub>IH</sub>  |  | 1.3  | -    | V <sub>DD</sub> + 0.3 | V    |      |
| JTAG input low voltage     | V <sub>IL</sub>  |  | -0.3 | -    | +0.5                  | V    |      |
| JTAG output high voltage   | V <sub>OH1</sub> | I <sub>OH</sub> C   = 100 μA                                   | 1.6  | -    | -                     | V    |      |
|                            | V <sub>OH2</sub> | I <sub>OH</sub> T   = 2 mA                                     | 1.4  | -    | -                     | V    |      |
| JTAG output low voltage    | V <sub>OL1</sub> | I <sub>OL</sub> C = 100 μA                                     | -    | -    | 0.2                   | V    |      |
|                            | V <sub>OL2</sub> | I <sub>OL</sub> T = 2 mA                                       | -    | -    | 0.4                   | V    |      |

JTAG AC Test Conditions

Input waveform (Rise / Fall time ≤ 1 ns)

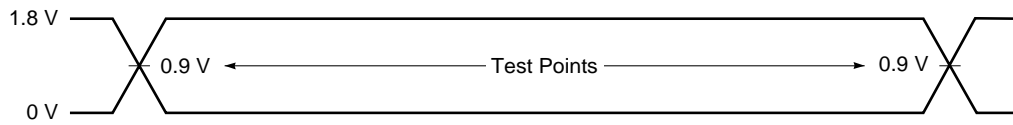

Output waveform

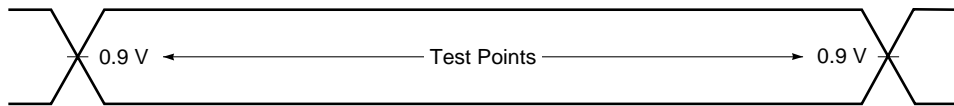

Output load

Figure 2. External load at test

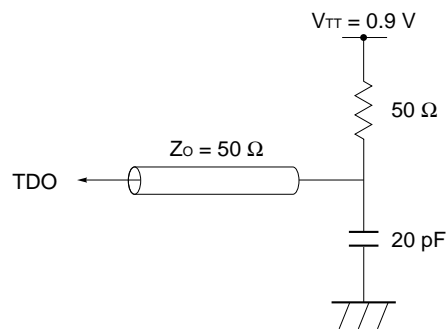

JTAG AC Characteristics (T<sub>A</sub> = 0 to 70 °C)

| Parameter               | Symbol            | Conditions | MIN. | TYP. | MAX. | Unit | Note |
|-------------------------|-------------------|------------|------|------|------|------|------|
| <b>Clock</b>            |                   |            |      |      |      |      |      |
| Clock cycle time        | t <sub>THTH</sub> |            | 100  | –    | –    | ns   |      |
| Clock frequency         | f <sub>TF</sub>   |            | –    | –    | 10   | MHz  |      |
| Clock high time         | t <sub>THTL</sub> |            | 40   | –    | –    | ns   |      |
| Clock low time          | t <sub>TLTH</sub> |            | 40   | –    | –    | ns   |      |
| <b>Output time</b>      |                   |            |      |      |      |      |      |
| TCK low to TDO unknown  | t <sub>TLOX</sub> |            | 0    | –    | –    | ns   |      |
| TCK low to TDO valid    | t <sub>TLOV</sub> |            | –    | –    | 20   | ns   |      |
| TDI valid to TCK high   | t <sub>DVTH</sub> |            | 10   | –    | –    | ns   |      |
| TCK high to TDI invalid | t <sub>THDX</sub> |            | 10   | –    | –    | ns   |      |
| <b>Setup time</b>       |                   |            |      |      |      |      |      |
| TMS setup time          | t <sub>MVTH</sub> |            | 10   | –    | –    | ns   |      |
| Capture setup time      | t <sub>CS</sub>   |            | 10   | –    | –    | ns   |      |
| <b>Hold time</b>        |                   |            |      |      |      |      |      |
| TMS hold time           | t <sub>THMX</sub> |            | 10   | –    | –    | ns   |      |
| Capture hold time       | t <sub>CH</sub>   |            | 10   | –    | –    | ns   |      |

JTAG Timing Diagram

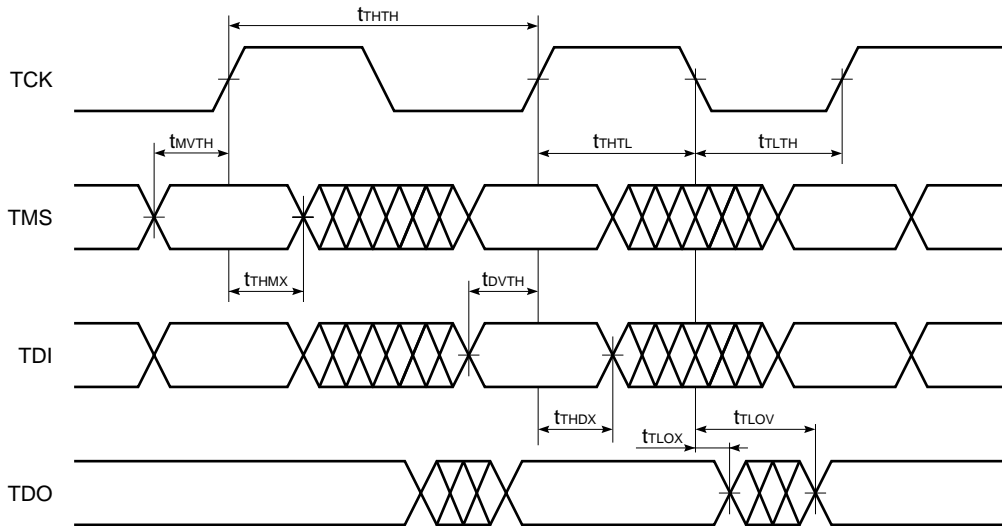

**Scan Register Definition (1)**

| Register name        | Description  |
|----------------------|--|
| Instruction register | The instruction register holds the instructions that are executed by the TAP controller when it is moved into the run-test/idle or the various data register state. The register can be loaded when it is placed between the TDI and TDO pins. The instruction register is automatically preloaded with the IDCODE instruction at power-up whenever the controller is placed in test-logic-reset state.  |
| Bypass register      | The bypass register is a single bit register that can be placed between TDI and TDO. It allows serial test data to be passed through the RAMs TAP to another device in the scan chain with as little delay as possible.  |
| ID register          | The ID Register is a 32 bit register that is loaded with a device and vendor specific 32 bit code when the controller is put in capture-DR state with the IDCODE command loaded in the instruction register. The register is then placed between the TDI and TDO pins when the controller is moved into shift-DR state.  |
| Boundary register    | The boundary register, under the control of the TAP controller, is loaded with the contents of the RAMs I/O ring when the controller is in capture-DR state and then is placed between the TDI and TDO pins when the controller is moved to shift-DR state. Several TAP instructions can be used to activate the boundary register.<br><br>The Scan Exit Order tables describe which device bump connects to each boundary register location. The first column defines the bit's position in the boundary register. The second column is the name of the input or I/O at the bump and the third column is the bump number. |

**Scan Register Definition (2)**

| Register name        | Bit size | Unit |
|----------------------|----------|------|
| Instruction register | 3        | bit  |
| Bypass register      | 1        | bit  |
| ID register          | 32       | bit  |
| Boundary register    | 107      | bit  |

**ID Register Definition**

| Part number | Organization | ID [31:28] vendor revision no. | ID [27:12] part no. | ID [11:1] vendor ID no. | ID [0] fix bit |
|-------------|--------------|--------------------------------|---------------------|-------------------------|----------------|
| μPD44164085 | 2M x 8       | XXXX                           | 0000 0000 0001 1000 | 00000010000             | 1              |
| μPD44164185 | 1M x 18      | XXXX                           | 0000 0000 0001 1001 | 00000010000             | 1              |
| μPD44164365 | 512K x 36    | XXXX                           | 0000 0000 0001 1010 | 00000010000             | 1              |

SCAN Exit Order

| Bit no. | Signal name |     |     | Bump ID |
|---------|-------------|-----|-----|---------|
|         | x8          | x18 | x36 |         |
| 1       | /C          |     |     | 6R      |
| 2       | C           |     |     | 6P      |
| 3       | A           |     |     | 6N      |
| 4       | A           |     |     | 7P      |
| 5       | A           |     |     | 7N      |
| 6       | A           |     |     | 7R      |
| 7       | A           |     |     | 8R      |
| 8       | A           |     |     | 8P      |
| 9       | A           |     |     | 9R      |
| 10      | NC          | Q0  | Q0  | 11P     |
| 11      | NC          | D0  | D0  | 10P     |
| 12      | NC          | NC  | D9  | 10N     |
| 13      | NC          | NC  | Q9  | 9P      |
| 14      | NC          | Q1  | Q1  | 10M     |
| 15      | NC          | D1  | D1  | 11N     |
| 16      | NC          | NC  | D10 | 9M      |
| 17      | NC          | NC  | Q10 | 9N      |
| 18      | Q0          | Q2  | Q2  | 11L     |
| 19      | D0          | D2  | D2  | 11M     |
| 20      | NC          | NC  | D11 | 9L      |
| 21      | NC          | NC  | Q11 | 10L     |
| 22      | NC          | Q3  | Q3  | 11K     |
| 23      | NC          | D3  | D3  | 10K     |
| 24      | NC          | NC  | D12 | 9J      |
| 25      | NC          | NC  | Q12 | 9K      |
| 26      | Q1          | Q4  | Q4  | 10J     |
| 27      | D1          | D4  | D4  | 11J     |
| 28      | ZQ          |     |     | 11H     |
| 29      | NC          | NC  | D13 | 10G     |
| 30      | NC          | NC  | Q13 | 9G      |
| 31      | NC          | Q5  | Q5  | 11F     |
| 32      | NC          | D5  | D5  | 11G     |
| 33      | NC          | NC  | D14 | 9F      |
| 34      | NC          | NC  | Q14 | 10F     |
| 35      | Q2          | Q6  | Q6  | 11E     |
| 36      | D2          | D6  | D6  | 10E     |

| Bit no. | Signal name |      |      | Bump ID  |
|---------|-------------|------|------|----------|
|         | x8          | x18  | x36  |          |
| 37      | NC          | NC   | D15  | 10D      |
| 38      | NC          | NC   | Q15  | 9E       |
| 39      | NC          | Q7   | Q7   | 10C      |
| 40      | NC          | D7   | D7   | 11D      |
| 41      | NC          | NC   | D16  | 9C       |
| 42      | NC          | NC   | Q16  | 9D       |
| 43      | Q3          | Q8   | Q8   | 11B      |
| 44      | D3          | D8   | D8   | 11C      |
| 45      | NC          | NC   | D17  | 9B       |
| 46      | NC          | NC   | Q17  | 10B      |
| 47      | CQ          |      |      | 11A      |
| 48      | -           |      |      | Internal |
| 49      | A           | A    | NC   | 9A       |
| 50      | A           |      |      | 8B       |
| 51      | A           |      |      | 7C       |
| 52      | A           |      |      | 6C       |
| 53      | /LD         |      |      | 8A       |
| 54      | NC          | NC   | /BW1 | 7A       |
| 55      | /NW0        | /BW0 | /BW0 | 7B       |
| 56      | K           |      |      | 6B       |
| 57      | /K          |      |      | 6A       |
| 58      | NC          | NC   | /BW3 | 5B       |
| 59      | /NW1        | /BW1 | /BW2 | 5A       |
| 60      | R, /W       |      |      | 4A       |
| 61      | A           |      |      | 5C       |
| 62      | A           |      |      | 4B       |
| 63      | A           | NC   | NC   | 3A       |
| 64      | /DLL        |      |      | 1H       |
| 65      | /CQ         |      |      | 1A       |
| 66      | NC          | Q9   | Q18  | 2B       |
| 67      | NC          | D9   | D18  | 3B       |
| 68      | NC          | NC   | D27  | 1C       |
| 69      | NC          | NC   | Q27  | 1B       |
| 70      | NC          | Q10  | Q19  | 3D       |
| 71      | NC          | D10  | D19  | 3C       |
| 72      | NC          | NC   | D28  | 1D       |

| Bit no. | Signal name |     |     | Bump ID |
|---------|-------------|-----|-----|---------|
|         | x8          | x18 | x36 |         |
| 73      | NC          | NC  | Q28 | 2C      |
| 74      | Q4          | Q11 | Q20 | 3E      |
| 75      | D4          | D11 | D20 | 2D      |
| 76      | NC          | NC  | D29 | 2E      |
| 77      | NC          | NC  | Q29 | 1E      |
| 78      | NC          | Q12 | Q21 | 2F      |
| 79      | NC          | D12 | D21 | 3F      |
| 80      | NC          | NC  | D30 | 1G      |
| 81      | NC          | NC  | Q30 | 1F      |
| 82      | Q5          | Q13 | Q22 | 3G      |
| 83      | D5          | D13 | D22 | 2G      |
| 84      | NC          | NC  | D31 | 1J      |
| 85      | NC          | NC  | Q31 | 2J      |
| 86      | NC          | Q14 | Q23 | 3K      |
| 87      | NC          | D14 | D23 | 3J      |
| 88      | NC          | NC  | D32 | 2K      |
| 89      | NC          | NC  | Q32 | 1K      |
| 90      | Q6          | Q15 | Q24 | 2L      |
| 91      | D6          | D15 | D24 | 3L      |
| 92      | NC          | NC  | D33 | 1M      |
| 93      | NC          | NC  | Q33 | 1L      |
| 94      | NC          | Q16 | Q25 | 3N      |
| 95      | NC          | D16 | D25 | 3M      |
| 96      | NC          | NC  | D34 | 1N      |
| 97      | NC          | NC  | Q34 | 2M      |
| 98      | Q7          | Q17 | Q26 | 3P      |
| 99      | D7          | D17 | D26 | 2N      |
| 100     | NC          | NC  | D35 | 2P      |
| 101     | NC          | NC  | Q35 | 1P      |
| 102     | A           |     |     | 3R      |
| 103     | A           |     |     | 4R      |
| 104     | A           |     |     | 4P      |
| 105     | A           |     |     | 5P      |
| 106     | A           |     |     | 5N      |
| 107     | A           |     |     | 5R      |

JTAG Instructions

| Instructions     | Description   |
|------------------|---|
| EXTEST           | The EXTEST instruction allows circuitry external to the component package to be tested. Boundary-scan register cells at output pins are used to apply test vectors, while those at input pins capture test results. Typically, the first test vector to be applied using the EXTEST instruction will be shifted into the boundary scan register using the PRELOAD instruction. Thus, during the update-IR state of EXTEST, the output driver is turned on and the PRELOAD data is driven onto the output pins.  |
| IDCODE           | The IDCODE instruction causes the ID ROM to be loaded into the ID register when the controller is in capture-DR mode and places the ID register between the TDI and TDO pins in shift-DR mode. The IDCODE instruction is the default instruction loaded in at power up and any time the controller is placed in the test-logic-reset state.   |
| BYPASS           | The BYPASS instruction is loaded in the instruction register when the bypass register is placed between TDI and TDO. This occurs when the TAP controller is moved to the shift-DR state. This allows the board level scan path to be shortened to facilitate testing of other devices in the scan path.   |
| SAMPLE / PRELOAD | SAMPLE / PRELOAD is a Standard 1149.1 mandatory public instruction. When the SAMPLE / PRELOAD instruction is loaded in the instruction register, moving the TAP controller into the capture-DR state loads the data in the RAMs input and Q pins into the boundary scan register. Because the RAM clock(s) are independent from the TAP clock (TCK) it is possible for the TAP to attempt to capture the I/O ring contents while the input buffers are in transition (i.e., in a metastable state). Although allowing the TAP to sample metastable input will not harm the device, repeatable results cannot be expected. RAM input signals must be stabilized for long enough to meet the TAPs input data capture setup plus hold time ( $t_{CS}$ plus $t_{CH}$ ). The RAMs clock inputs need not be paused for any other TAP operation except capturing the I/O ring contents into the boundary scan register. Moving the controller to shift-DR state then places the boundary scan register between the TDI and TDO pins. |
| SAMPLE-Z         | If the SAMPLE-Z instruction is loaded in the instruction register, all RAM Q pins are forced to an inactive drive state (high impedance) and the boundary register is connected between TDI and TDO when the TAP controller is moved to the shift-DR state.   |

JTAG Instruction Coding

| IR2 | IR1 | IR0 | Instruction      | Note |
|-----|-----|-----|------------------|------|
| 0   | 0   | 0   | EXTEST           |      |
| 0   | 0   | 1   | IDCODE           |      |
| 0   | 1   | 0   | SAMPLE-Z         | 1    |
| 0   | 1   | 1   | RESERVED         |      |
| 1   | 0   | 0   | SAMPLE / PRELOAD |      |
| 1   | 0   | 1   | RESERVED         |      |
| 1   | 1   | 0   | RESERVED         |      |
| 1   | 1   | 1   | BYPASS           |      |

**Note 1.** TRISTATE all Q pins and CAPTURE the pad values into a SERIAL SCAN LATCH.

TAP Controller State Diagram

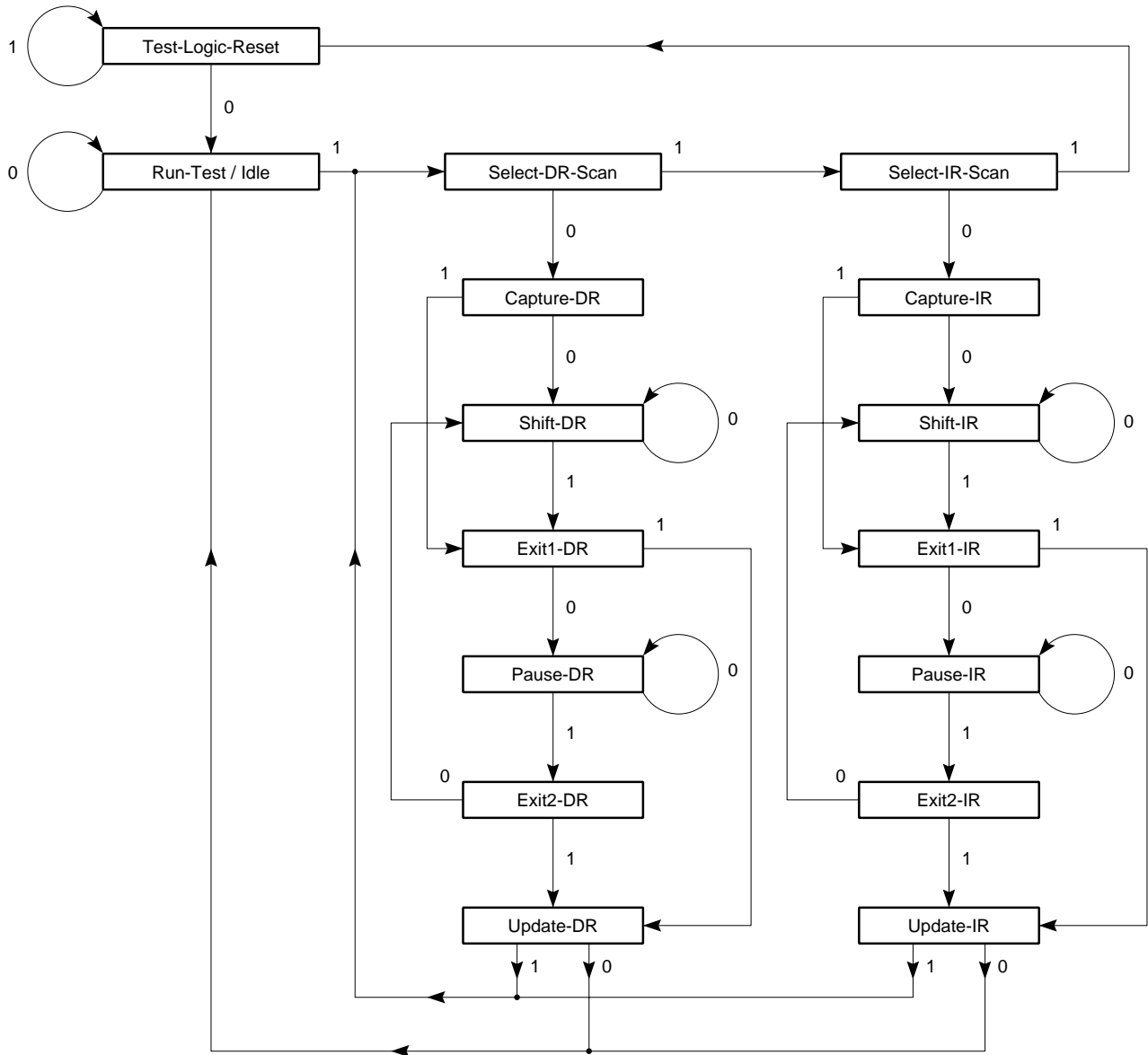

**Disabling the Test Access Port**

It is possible to use this device without utilizing the TAP. To disable the TAP Controller without interfering with normal operation of the device, TCK must be tied to Vss to preclude mid level inputs.

TDI and TMS are designed so an undriven input will produce a response identical to the application of a logic 1, and may be left unconnected. But they may also be tied to VDD through a 1 kΩ resistor.

TDO should be left unconnected.

Test Logic Operation (Instruction Scan)

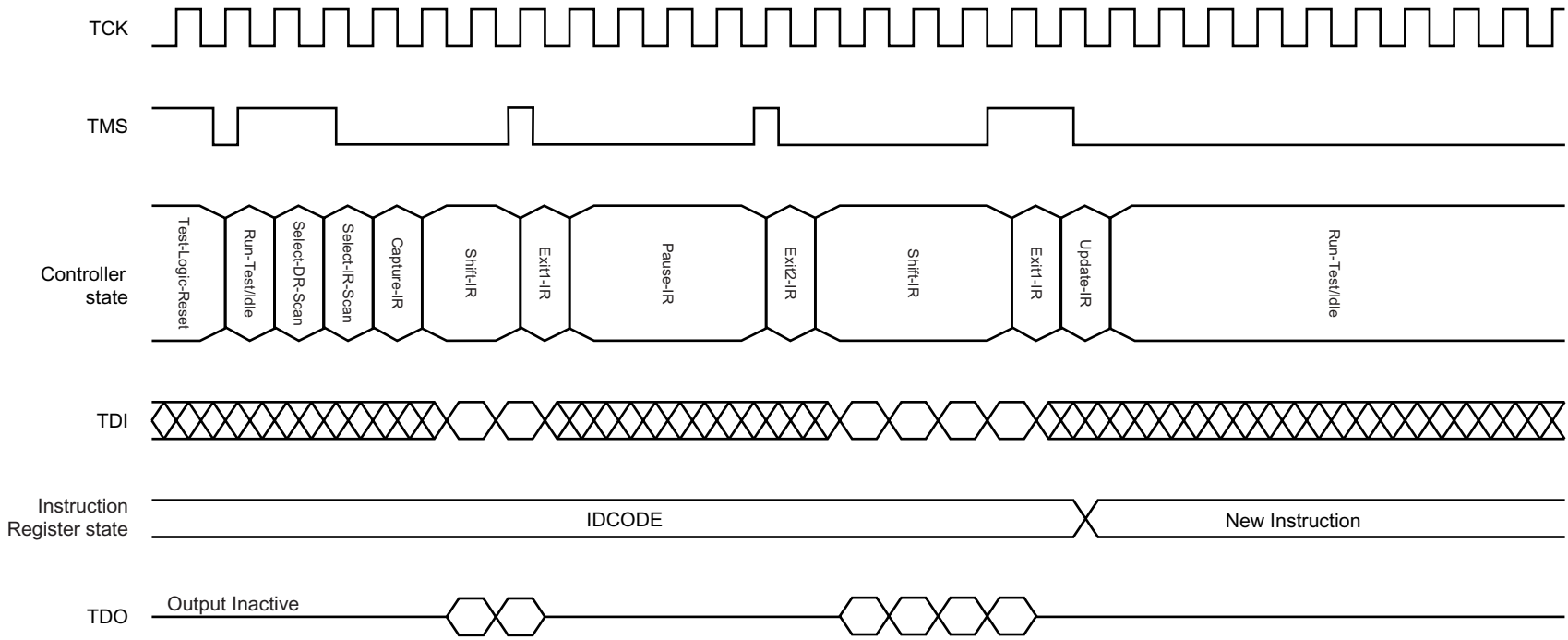



Test Logic (Data Scan)

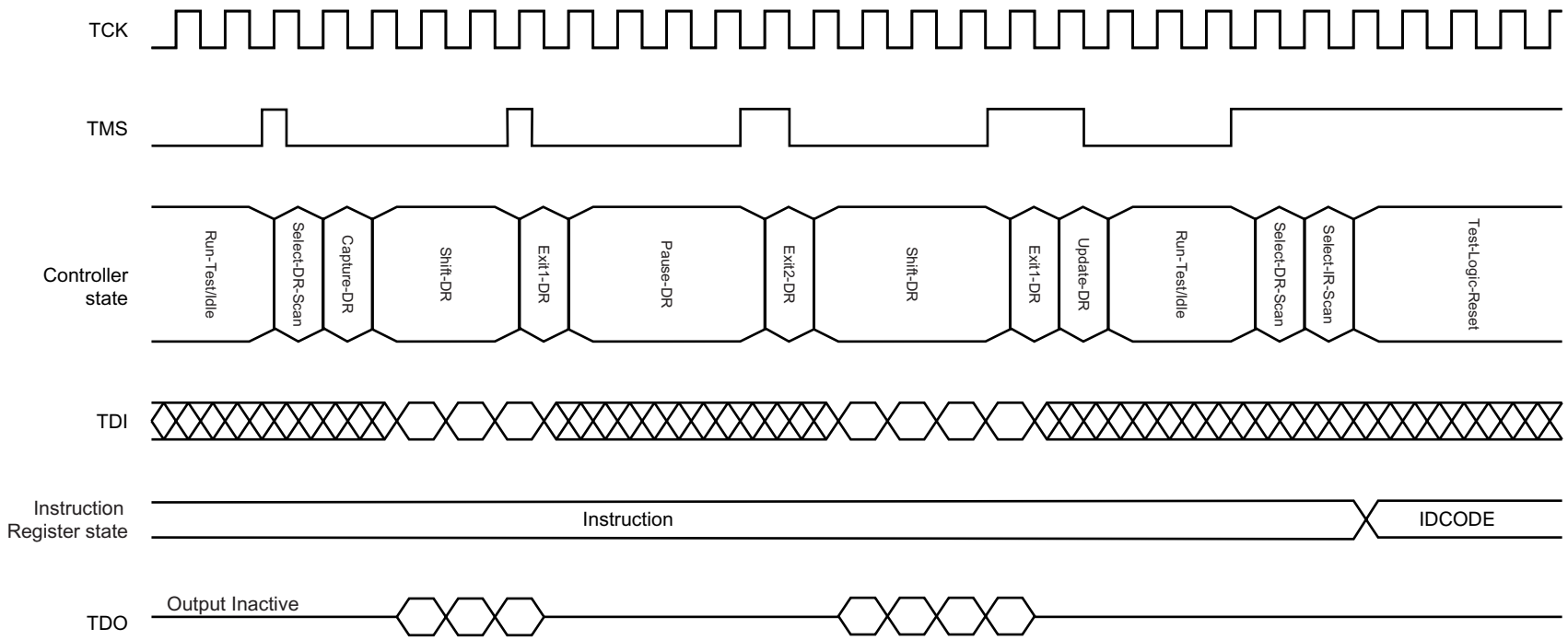

★ Package Drawing

165-PIN PLASTIC BGA (13x15)

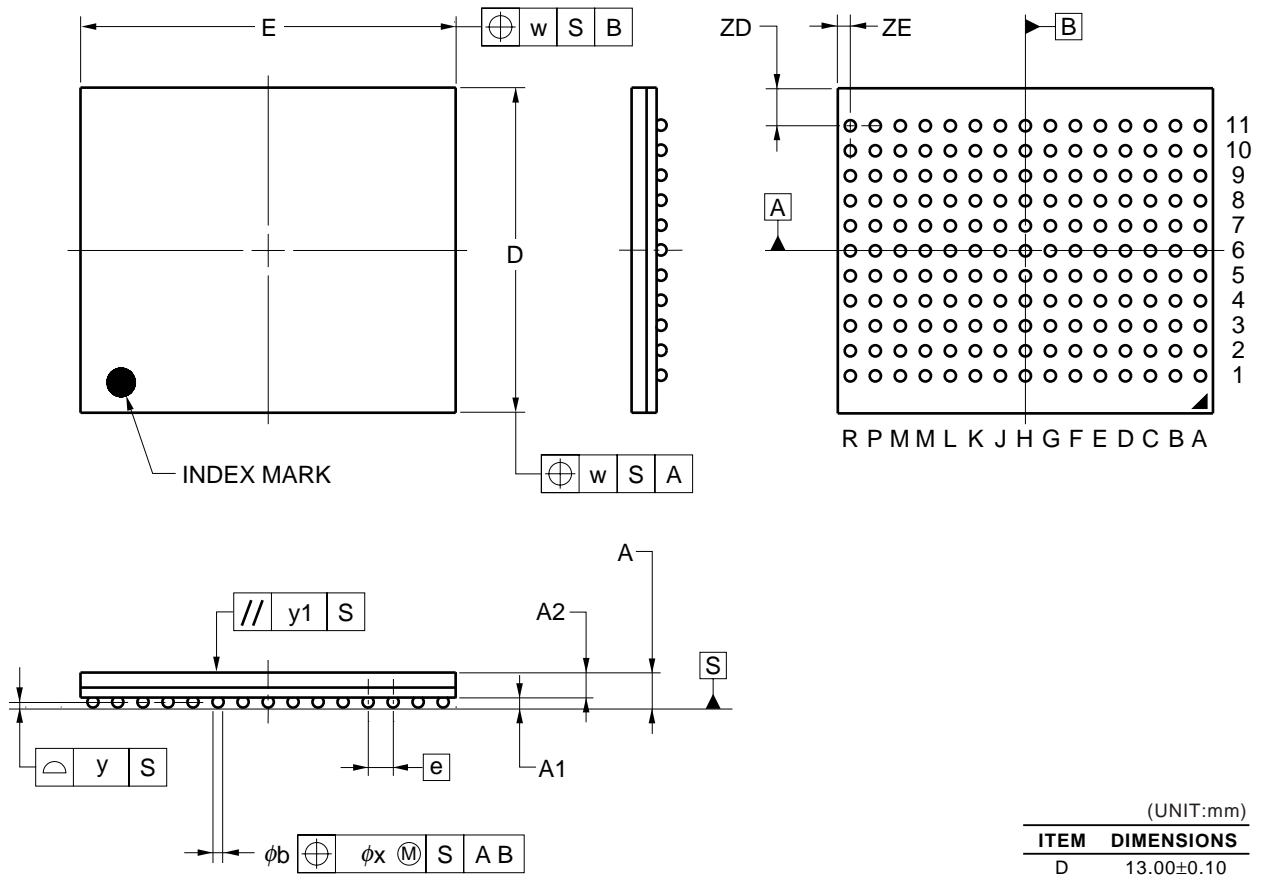

(UNIT:mm)

| ITEM | DIMENSIONS |
|------|------------|
| D    | 13.00±0.10 |
| E    | 15.00±0.10 |
| w    | 0.15       |
| e    | 1.00       |
| A    | 1.40±0.11  |
| A1   | 0.40±0.05  |
| A2   | 1.00       |
| b    | 0.50±0.05  |
| x    | 0.08       |
| y    | 0.10       |
| y1   | 0.20       |
| ZD   | 1.50       |
| ZE   | 0.50       |

P165F5-100-EQ1

**Recommended Soldering Condition**

Please consult with our sales offices for soldering conditions of these products.



**Types of Surface Mount Devices**

μPD44164085F5-EQ1: 165-pin PLASTIC BGA (13 x 15)

μPD44164185F5-EQ1: 165-pin PLASTIC BGA (13 x 15)

μPD44164365F5-EQ1: 165-pin PLASTIC BGA (13 x 15)

Revision History

| Edition/<br>Date          | Page            |                     | Type of<br>revision | Location                                   | Description<br>(Previous edition → This edition)  |  |      |  |      |         |     |      |     |     |    |      |     |     |      |     |     |  |      |  |      |         |     |      |     |   |    |      |     |     |      |     |     |
|---------------------------|-----------------|---------------------|---------------------|--|---|--|------|--|------|---------|-----|------|-----|-----|----|------|-----|-----|------|-----|-----|--|------|--|------|---------|-----|------|-----|---|----|------|-----|-----|------|-----|-----|
|                           | This<br>edition | Previous<br>edition |                     |  |   |  |      |  |      |         |     |      |     |     |    |      |     |     |      |     |     |  |      |  |      |         |     |      |     |   |    |      |     |     |      |     |     |
| 7th edition/<br>Feb. 2004 | Throughout      | Throughout          | Deletion            | Ordering Information                       | μ PD44164365F5-E40-EQ1  |  |      |  |      |         |     |      |     |     |    |      |     |     |      |     |     |  |      |  |      |         |     |      |     |   |    |      |     |     |      |     |     |
|                           | p.12            | p.12                | Modification        | DC Characteristics I <sub>DD</sub> (MAX.)  | <table border="1"> <thead> <tr> <th rowspan="2"></th> <th colspan="2">MAX.</th> <th rowspan="2">Unit</th> </tr> <tr> <th>x8, x18</th> <th>x36</th> </tr> </thead> <tbody> <tr> <td>-E40</td> <td>600</td> <td>TBD</td> <td rowspan="3">mA</td> </tr> <tr> <td>-E50</td> <td>500</td> <td>600</td> </tr> <tr> <td>-E60</td> <td>430</td> <td>520</td> </tr> </tbody> </table>  <table border="1"> <thead> <tr> <th rowspan="2"></th> <th colspan="2">MAX.</th> <th rowspan="2">Unit</th> </tr> <tr> <th>x8, x18</th> <th>x36</th> </tr> </thead> <tbody> <tr> <td>-E40</td> <td>650</td> <td>-</td> <td rowspan="3">mA</td> </tr> <tr> <td>-E50</td> <td>550</td> <td>650</td> </tr> <tr> <td>-E60</td> <td>480</td> <td>570</td> </tr> </tbody> </table> |  | MAX. |  | Unit | x8, x18 | x36 | -E40 | 600 | TBD | mA | -E50 | 500 | 600 | -E60 | 430 | 520 |  | MAX. |  | Unit | x8, x18 | x36 | -E40 | 650 | - | mA | -E50 | 550 | 650 | -E60 | 480 | 570 |
|                           | MAX.            |                     | Unit                |  |   |  |      |  |      |         |     |      |     |     |    |      |     |     |      |     |     |  |      |  |      |         |     |      |     |   |    |      |     |     |      |     |     |
|                           | x8, x18         | x36                 |                     |  |   |  |      |  |      |         |     |      |     |     |    |      |     |     |      |     |     |  |      |  |      |         |     |      |     |   |    |      |     |     |      |     |     |
| -E40                      | 600             | TBD                 | mA                  |  |   |  |      |  |      |         |     |      |     |     |    |      |     |     |      |     |     |  |      |  |      |         |     |      |     |   |    |      |     |     |      |     |     |
| -E50                      | 500             | 600                 |                     |  |   |  |      |  |      |         |     |      |     |     |    |      |     |     |      |     |     |  |      |  |      |         |     |      |     |   |    |      |     |     |      |     |     |
| -E60                      | 430             | 520                 |                     |  |   |  |      |  |      |         |     |      |     |     |    |      |     |     |      |     |     |  |      |  |      |         |     |      |     |   |    |      |     |     |      |     |     |
|                           | MAX.            |                     | Unit                |  |   |  |      |  |      |         |     |      |     |     |    |      |     |     |      |     |     |  |      |  |      |         |     |      |     |   |    |      |     |     |      |     |     |
|                           | x8, x18         | x36                 |                     |  |   |  |      |  |      |         |     |      |     |     |    |      |     |     |      |     |     |  |      |  |      |         |     |      |     |   |    |      |     |     |      |     |     |
| -E40                      | 650             | -                   | mA                  |  |   |  |      |  |      |         |     |      |     |     |    |      |     |     |      |     |     |  |      |  |      |         |     |      |     |   |    |      |     |     |      |     |     |
| -E50                      | 550             | 650                 |                     |  |   |  |      |  |      |         |     |      |     |     |    |      |     |     |      |     |     |  |      |  |      |         |     |      |     |   |    |      |     |     |      |     |     |
| -E60                      | 480             | 570                 |                     |  |   |  |      |  |      |         |     |      |     |     |    |      |     |     |      |     |     |  |      |  |      |         |     |      |     |   |    |      |     |     |      |     |     |
|                           |                 |                     |                     | DC Characteristics I <sub>SB1</sub> (MAX.) | <table border="1"> <thead> <tr> <th rowspan="2"></th> <th colspan="2">MAX.</th> <th rowspan="2">Unit</th> </tr> <tr> <th>x8, x18</th> <th>x36</th> </tr> </thead> <tbody> <tr> <td>-E40</td> <td colspan="2">250</td> <td rowspan="3">mA</td> </tr> <tr> <td>-E50</td> <td colspan="2">210</td> </tr> <tr> <td>-E60</td> <td colspan="2">190</td> </tr> </tbody> </table>  <table border="1"> <thead> <tr> <th rowspan="2"></th> <th colspan="2">MAX.</th> <th rowspan="2">Unit</th> </tr> <tr> <th>x8, x18</th> <th>x36</th> </tr> </thead> <tbody> <tr> <td>-E40</td> <td>320</td> <td>-</td> <td rowspan="3">mA</td> </tr> <tr> <td>-E50</td> <td colspan="2">270</td> </tr> <tr> <td>-E60</td> <td colspan="2">250</td> </tr> </tbody> </table>      |  | MAX. |  | Unit | x8, x18 | x36 | -E40 | 250 |     | mA | -E50 | 210 |     | -E60 | 190 |     |  | MAX. |  | Unit | x8, x18 | x36 | -E40 | 320 | - | mA | -E50 | 270 |     | -E60 | 250 |     |
|                           | MAX.            |                     | Unit                |  |   |  |      |  |      |         |     |      |     |     |    |      |     |     |      |     |     |  |      |  |      |         |     |      |     |   |    |      |     |     |      |     |     |
|                           | x8, x18         | x36                 |                     |  |   |  |      |  |      |         |     |      |     |     |    |      |     |     |      |     |     |  |      |  |      |         |     |      |     |   |    |      |     |     |      |     |     |
| -E40                      | 250             |                     | mA                  |  |   |  |      |  |      |         |     |      |     |     |    |      |     |     |      |     |     |  |      |  |      |         |     |      |     |   |    |      |     |     |      |     |     |
| -E50                      | 210             |                     |                     |  |   |  |      |  |      |         |     |      |     |     |    |      |     |     |      |     |     |  |      |  |      |         |     |      |     |   |    |      |     |     |      |     |     |
| -E60                      | 190             |                     |                     |  |   |  |      |  |      |         |     |      |     |     |    |      |     |     |      |     |     |  |      |  |      |         |     |      |     |   |    |      |     |     |      |     |     |
|                           | MAX.            |                     | Unit                |  |   |  |      |  |      |         |     |      |     |     |    |      |     |     |      |     |     |  |      |  |      |         |     |      |     |   |    |      |     |     |      |     |     |
|                           | x8, x18         | x36                 |                     |  |   |  |      |  |      |         |     |      |     |     |    |      |     |     |      |     |     |  |      |  |      |         |     |      |     |   |    |      |     |     |      |     |     |
| -E40                      | 320             | -                   | mA                  |  |   |  |      |  |      |         |     |      |     |     |    |      |     |     |      |     |     |  |      |  |      |         |     |      |     |   |    |      |     |     |      |     |     |
| -E50                      | 270             |                     |                     |  |   |  |      |  |      |         |     |      |     |     |    |      |     |     |      |     |     |  |      |  |      |         |     |      |     |   |    |      |     |     |      |     |     |
| -E60                      | 250             |                     |                     |  |   |  |      |  |      |         |     |      |     |     |    |      |     |     |      |     |     |  |      |  |      |         |     |      |     |   |    |      |     |     |      |     |     |
|                           | p.26            | p.26                | Modification        | Package Drawing                            | Preliminary version → Standardized version  |  |      |  |      |         |     |      |     |     |    |      |     |     |      |     |     |  |      |  |      |         |     |      |     |   |    |      |     |     |      |     |     |

[MEMO]

[MEMO]

## NOTES FOR CMOS DEVICES

**① VOLTAGE APPLICATION WAVEFORM AT INPUT PIN**

Waveform distortion due to input noise or a reflected wave may cause malfunction. If the input of the CMOS device stays in the area between  $V_{IL}$  (MAX) and  $V_{IH}$  (MIN) due to noise, etc., the device may malfunction. Take care to prevent chattering noise from entering the device when the input level is fixed, and also in the transition period when the input level passes through the area between  $V_{IL}$  (MAX) and  $V_{IH}$  (MIN).

**② HANDLING OF UNUSED INPUT PINS**

Unconnected CMOS device inputs can be cause of malfunction. If an input pin is unconnected, it is possible that an internal input level may be generated due to noise, etc., causing malfunction. CMOS devices behave differently than Bipolar or NMOS devices. Input levels of CMOS devices must be fixed high or low by using pull-up or pull-down circuitry. Each unused pin should be connected to  $V_{DD}$  or GND via a resistor if there is a possibility that it will be an output pin. All handling related to unused pins must be judged separately for each device and according to related specifications governing the device.

**③ PRECAUTION AGAINST ESD**

A strong electric field, when exposed to a MOS device, can cause destruction of the gate oxide and ultimately degrade the device operation. Steps must be taken to stop generation of static electricity as much as possible, and quickly dissipate it when it has occurred. Environmental control must be adequate. When it is dry, a humidifier should be used. It is recommended to avoid using insulators that easily build up static electricity. Semiconductor devices must be stored and transported in an anti-static container, static shielding bag or conductive material. All test and measurement tools including work benches and floors should be grounded. The operator should be grounded using a wrist strap. Semiconductor devices must not be touched with bare hands. Similar precautions need to be taken for PW boards with mounted semiconductor devices.

**④ STATUS BEFORE INITIALIZATION**

Power-on does not necessarily define the initial status of a MOS device. Immediately after the power source is turned ON, devices with reset functions have not yet been initialized. Hence, power-on does not guarantee output pin levels, I/O settings or contents of registers. A device is not initialized until the reset signal is received. A reset operation must be executed immediately after power-on for devices with reset functions.

- **The information in this document is current as of July, 2004. The information is subject to change without notice. For actual design-in, refer to the latest publications of NEC Electronics data sheets or data books, etc., for the most up-to-date specifications of NEC Electronics products. Not all products and/or types are available in every country. Please check with an NEC Electronics sales representative for availability and additional information.**
- No part of this document may be copied or reproduced in any form or by any means without the prior written consent of NEC Electronics. NEC Electronics assumes no responsibility for any errors that may appear in this document.
- NEC Electronics does not assume any liability for infringement of patents, copyrights or other intellectual property rights of third parties by or arising from the use of NEC Electronics products listed in this document or any other liability arising from the use of such products. No license, express, implied or otherwise, is granted under any patents, copyrights or other intellectual property rights of NEC Electronics or others.
- Descriptions of circuits, software and other related information in this document are provided for illustrative purposes in semiconductor product operation and application examples. The incorporation of these circuits, software and information in the design of a customer's equipment shall be done under the full responsibility of the customer. NEC Electronics assumes no responsibility for any losses incurred by customers or third parties arising from the use of these circuits, software and information.
- While NEC Electronics endeavors to enhance the quality, reliability and safety of NEC Electronics products, customers agree and acknowledge that the possibility of defects thereof cannot be eliminated entirely. To minimize risks of damage to property or injury (including death) to persons arising from defects in NEC Electronics products, customers must incorporate sufficient safety measures in their design, such as redundancy, fire-containment and anti-failure features.
- NEC Electronics products are classified into the following three quality grades: "Standard", "Special" and "Specific".  
The "Specific" quality grade applies only to NEC Electronics products developed based on a customer-designated "quality assurance program" for a specific application. The recommended applications of an NEC Electronics product depend on its quality grade, as indicated below. Customers must check the quality grade of each NEC Electronics product before using it in a particular application.  
"Standard": Computers, office equipment, communications equipment, test and measurement equipment, audio and visual equipment, home electronic appliances, machine tools, personal electronic equipment and industrial robots.  
"Special": Transportation equipment (automobiles, trains, ships, etc.), traffic control systems, anti-disaster systems, anti-crime systems, safety equipment and medical equipment (not specifically designed for life support).  
"Specific": Aircraft, aerospace equipment, submersible repeaters, nuclear reactor control systems, life support systems and medical equipment for life support, etc.

The quality grade of NEC Electronics products is "Standard" unless otherwise expressly specified in NEC Electronics data sheets or data books, etc. If customers wish to use NEC Electronics products in applications not intended by NEC Electronics, they must contact an NEC Electronics sales representative in advance to determine NEC Electronics' willingness to support a given application.

(Note)

- (1) "NEC Electronics" as used in this statement means NEC Electronics Corporation and also includes its majority-owned subsidiaries.
- (2) "NEC Electronics products" means any product developed or manufactured by or for NEC Electronics (as defined above).